

COMPANY PROFILE





atos 
GROUP

INDEX

| | |
|-----------------------------|----|
| ABOUT US | 4 |
| MISSION | 5 |
| ATOS GROUP | 6 |
| THE SMART ELECTROHYDRAULICS | 8 |
| ATOS WORLDWIDE | 10 |
| ATOS NUMBERS | 11 |
| THE ATOS DIFFERENCE | 12 |
| THE ATOS RANGE | 20 |
| PROPORTIONAL VALVES | 22 |
| AXIS & P/Q CONTROLS | 25 |
| ON-OFF VALVES | 26 |
| CYLINDERS | 29 |
| PUMPS - FILTERS | 30 |
| SYSTEMS | 31 |
| THE ATOS WAY | 32 |

ABOUT US

Established in 1957 from the concept of Luciano Crespi, in 60 years of experience we have written the history of electrohydraulics

Now we are a Group operating in more than 80 countries, with 9 production sites in Italy, China, USA and India with over 750 professionals who share the same passion for innovation, technology and creativity

We are specialists, 100% dedicated to electrohydraulics, in a constant search of innovative solutions for any application, from the industrial ones with our high-performance axis controls, to the explosion-proof line for hazardous locations and the stainless steel one for corrosive environments and fluids



MISSION

We believe in the **value of technology** and we are constantly searching for **innovation** and **quality** thanks to our **people's value**



ATOS GROUP

NUMBERS



170
MILLION
TURNOVER

750
EMPLOYEES

80.000
M² PLANTS

10%
INVESTMENTS R&D
ON TURNOVER

75
QUALITY
STAFF

1,5
MILLION
COMPONENTS

OVER 100.000
PROPORTIONAL
VALVES / YEARS

15
MILLION
FITTINGS

PRODUCTION SITES



Sesto Calende (VA) - 27.000 m²

Modena - 6.000 m²

Trieste - 3.000 m²

Angera (VA) - 5.000 m²

Inverio (NO) - 11.000 m²

Galliate (NO) - 15.000 m²



Shanghai - 7.000 m²



York (PA) - 5.000 m²



Ahmedabad - 1.000 m²



ATOS GROUP

ORGANIZATION

ATOS DIVISIONS

VALVES - proportionals & on/off - SESTO CALENDE, TRIESTE, SHANGHAI, YORK (PA), AHMEDABAD

ELECTRONICS - digital drivers, controllers & transducers - SESTO CALENDE

CYLINDERS - cylinders, servocylinders & servoactuators - MODENA

PUMPS - vane & piston - SESTO CALENDE

FILTERS - in line, return line, suction - SESTO CALENDE

SYSTEMS - power units & blocks - ANGERA, SHANGHAI, YORK (PA), AHMEDABAD

ATOS GROUP COMPANIES

ATOS INDUCTION - induction heating systems - SESTO CALENDE

RACCORDERIE TAA - hydraulic fittings, valves and rails - INVORIO

TRIVI - systems for the food industry - GALLIATE





ATOS, THE SMART ELECTROHYDRAULICS

Smart Electrohydraulics is the vision that sums up the four values leading our actions: **responsibility**, **excellence**, **innovation** and **passion**

For Atos, being Smart means courage and determination to define new standards of excellence. A new approach in which each process is analysed and optimized: from design to production, from delivery to after-sales service

Smart Electrohydraulics is our response to market demands for advanced solutions that are easy to install and use



SMART COMPANY

Technology and innovation drive the research into new sustainable and efficient solutions



SMART PRODUCTS

Atos products are unique in terms ease of use, intelligence and automation, always keeping the highest standards of reliability and safety



SMART PEOPLE

Our people act as a team, motivated to grow and encouraged to propose innovative ideas and improvements in all business fields



SMART PARTNER

Our relationships are transparent, reactive and proactive, in the spirit of collaboration which only a passionate approach can generate

SMART

ATOS

WORLDWIDE

A sales network with 25 branches, 120 sales professionals and distributors in more than 80 countries, together with great responsiveness and focus on customers. This is how our relationships become real partnerships



SALES BY GEOGRAPHIC AREA

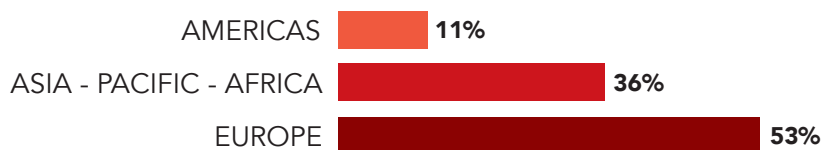

ATOS

NUMBERS

Proportional valves/year **over 100000**

**100%
DIGITAL**



over **500000** NG6 on-off valves/year



Ex-proof valves/years **over 35000**



over **30000** Cylinders/year,
10% are servocylinders

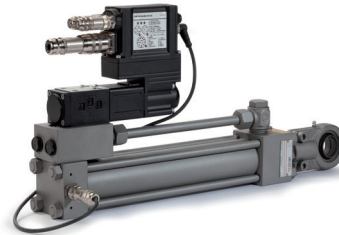

SALES BY PRODUCT LINES

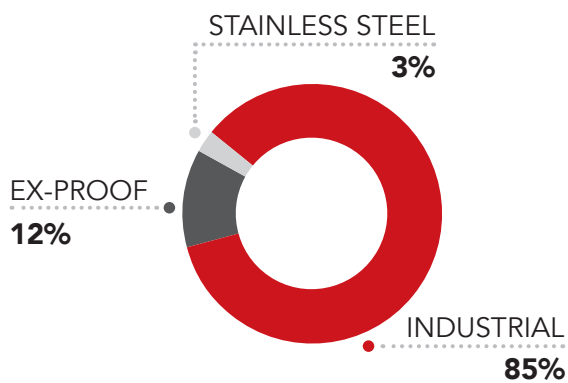

SALES BY PRODUCT CATEGORIES

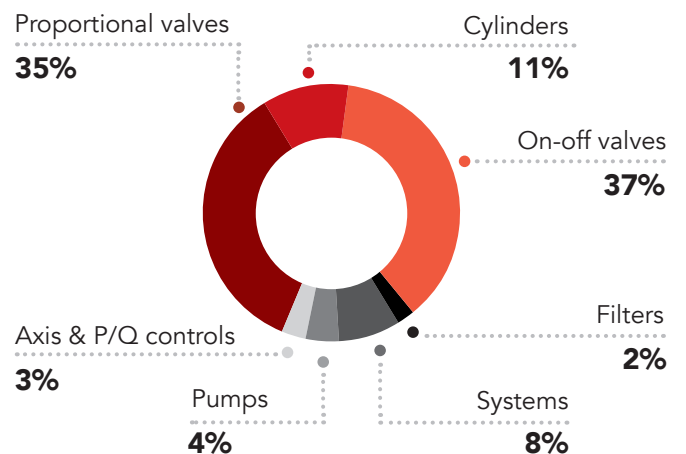

THE ATOS DIFFERENCE

ATOS WINNING MIX

Atos offers a unique and winning mix with the organization and methods of a multinational combined with the flexibility, responsiveness, service and customer focus, typical of a private company:

- 4 weeks delivery with 3 days ultra-fast channel
- 15% of Atos production tailored according to customer requirements
- exclusive configuration software for simple and guided selection of any product within the range
- pre and after-sales support network, directly supported and coordinated by the Headquarters

TECHNOLOGY

Our focus is innovation, developed through laboratory research, CFD/FEM analysis and simulations of extreme environments

We internally develop all the electro-hydraulic know-how: fluidics, mechanics and electronics, in order to quickly provide solutions for any application

QUALITY

Quality is the company's mission at all levels. Atos is certified according to the main international standards, with the application of IATF automotive methods:

- ISO 9001 - Quality Management
- ISO 14001 - Environmental Management
- ISO 45001 - Health & Safety Management

A long list of certifications confirm the quality of Atos

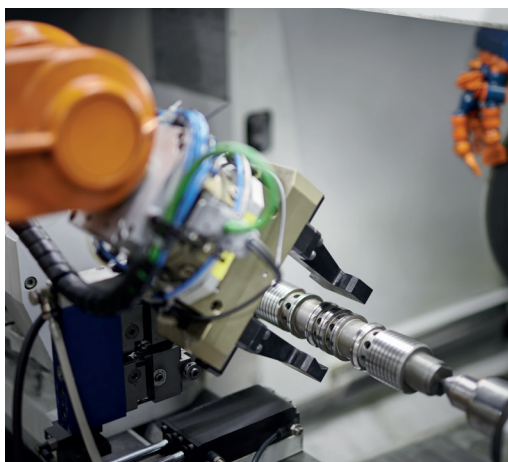
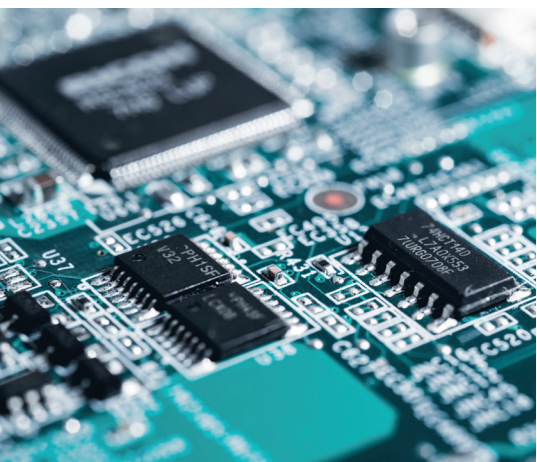

THE ATOS DIFFERENCE

100% DIGITAL ELECTROHYDRAULICS

The Atos proportional range sets new standards for industrial hydraulics

100HZ
DYNAMICS

PRESSURE
420
BAR

50G
SHOCK

IP
66/67

Atos software allows easy access to configurations, advanced diagnostics, alarm history and integrated oscilloscope

Industry 4.0 fieldbus provide real-time access to functional parameters, diagnostics, transducers and feedback

USB
UNIVERSAL SERIAL BUS

Bluetooth®

 **IO-Link**

CANopen

PROFI
BUS

ETHERNET
POWERLINK

EtherCAT

PROFI
NET

EtherNet/IP

SMART TUNING

The multiple dynamic configurations allow Atos proportionals to adapt their functional characteristics to any application or specific phase of a work cycle, thus simplifying the system start up

Each dynamic configuration can be easily customized with specific settings



atos® 

E-RI-TEB-N-NP-01H

DLHZO-TEB-SN-NP-040-L01 1

(B)

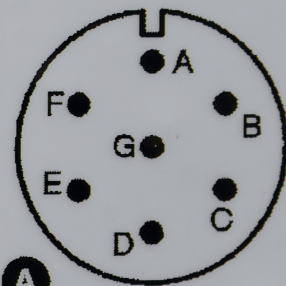

A: MAIN
A: V+ ext.
B: V0
C: AGND
D: Q_INPU

(A)

T-966

THE ATOS DIFFERENCE

P/Q CONTROLS

Integrate max pressure or force control to the standard flow regulation of proportional valves and pumps

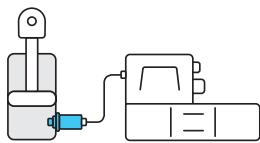

pressure control
1 pressure transducer

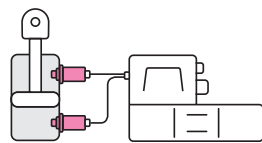

force control
2 pressure transducers

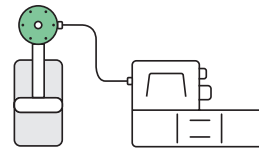

force control
load cell

AXIS CONTROLS

Smart proportionals with on-board axis control cards perform position & speed control of any hydraulic actuator, increasing their performance

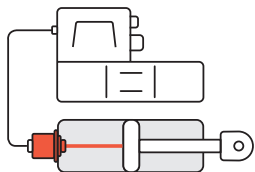

motion control
position transducer

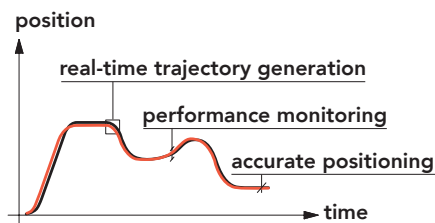

Available in P/Q executions for max force limiting during the motion cycle

SAFETY ELECTROHYDRAULICS

Proportional and on-off safety valves are designed and developed in compliance with international standards:

- IEC 61508 & ISO 13849
- Machine Directive 2006/42/EC
- PED Directive 2014/68/EU

They are certified by DEKRA or TÜV for functional safety



THE ATOS DIFFERENCE

ECP - ENHANCED CORROSION PROTECTION

The exclusive Atos galvanizing process guarantees excellent surface protection for aggressive environments



SPECIAL FLUIDS

A range of options dedicated to Atos products, permits full compatibility with fire-proof or eco-friendly fluids



LOW TEMPERATURES

Atos components are available in specific executions to make them perform optimally even in cold environments



THE ATOS DIFFERENCE

HAZARDOUS ATMOSPHERES

The Atos Ex-proof line is certified to safely operate in mining or surface environments with potentially explosive mixtures of liquid, gas and dust



EUROPE



INTERNATIONAL



EURASIAN



NORTH AMERICA



CHINA



CHINA



INDIA



JAPAN

Flame-proof proportionals with on-board electronics allow solutions developed for industrial sector to be extended also to hazardous locations

Intrinsically safe valves provide the highest protection level in environments with very high risk of explosion - up to Zone 0

EXTREME ENVIRONMENTS

The stainless steel line provides the highest resistance to low temperatures, corrosive environments and fluids



X FULL
STAINLESS STEEL

XS EXTERNAL
STAINLESS STEEL

XW INTERNAL
STAINLESS STEEL

Stainless steel components can be supplied with Ex-proof certifications to operate in hazardous environments

THE ATOS RANGE

PRODUCT LINES

The Atos range is represented by 3 product lines and 7 categories to provide easy access to the wide and ever-evolving product portfolio



INDUSTRIAL

High performance hydraulics meet advanced digital technology

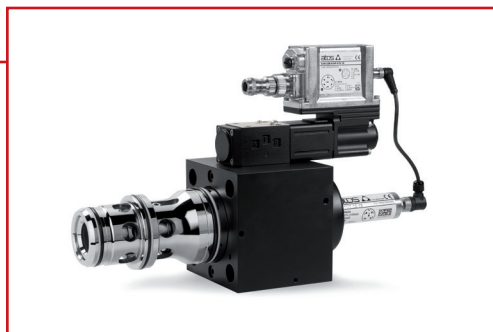

SECTORS:

- Manufacturing
- Defense
- Wind
- Construction
- Agriculture
- Transportation



EX-PROOF

Engineered for safe operation in hazardous environments

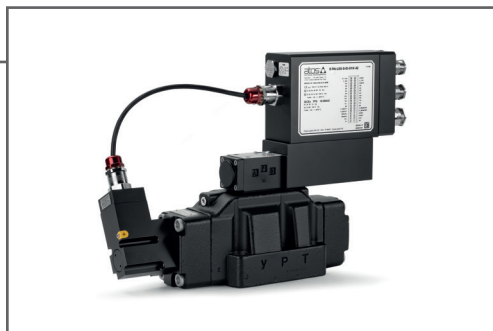

SECTORS:

- Oil & gas
- Mining
- Energy



STAINLESS STEEL

The highest resistance to corrosive environments and fluids

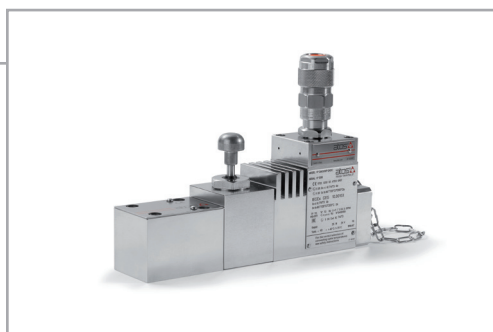

SECTORS:

- Marine
- Chemical
- Food

THE ATOS RANGE

PRODUCT CATEGORIES

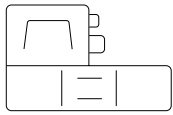

PROPORTIONAL VALVES

A unique range, from simple valves without transducers to servoproportionals

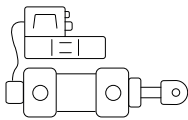

AXIS & P/Q CONTROLS

Servosystems with digital axis cards for position, speed and force control of any hydraulic actuator



ON-OFF VALVES

A full range of reliable components to satisfy the most demanding applications



CYLINDERS

ISO executions with rugged design, engineered for high speeds, low friction and extended operative life

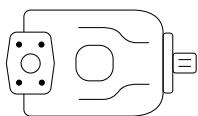

PUMPS

Fixed or variable displacement, for high pressure applications with low noise and long service life

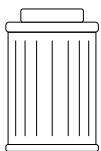

FILTERS

Equipped with high efficiency microfiber elements for optimal fluid cleanliness

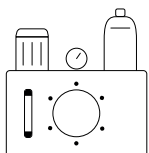

SYSTEMS

Power units and hydraulic blocks tailored for any hydraulic application, environment and working condition



PROPORTIONAL VALVES

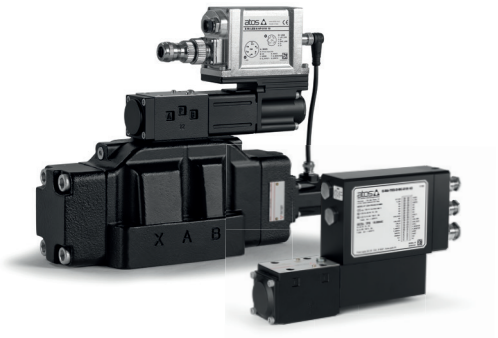

SERVOPROPORTIONAL DIRECTIONALS

For high precision motion controls.
Zero overlap executions with LVDT transducers

- 4/4, 4/3 way • ISO sizes 06 ÷ 35
- Qmax 3.500 l/min • Pmax 350 bar

HIGH PERFORMANCE DIRECTIONALS

Positive overlap executions with LVDT transducers
for high dynamic directional and speed controls

- 4/3, 4/2 way • ISO sizes 06 ÷ 35
- Qmax 3.500 l/min • Pmax 350 bar



SERVOCARTRIDGES

High flow for highest dynamic control.
With 2 LVDT transducers

- 3 way • sizes 25 ÷ 80
- Qmax 5.000 l/min • Pmax 420 bar

HIGH PERFORMANCE CARTRIDGES

High flow speed controls with ultra-fast
response time. With 2 LVDT transducers

- 2 way • ISO sizes 16 ÷ 125
- Qmax 22.000 l/min • Pmax 420 bar

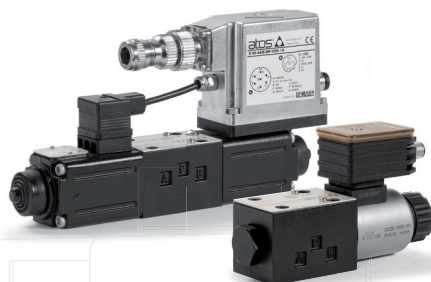

DIRECTIONALS

Full range of proportionals without LVDT transducers

- 4/3, 4/2 way • ISO sizes 06 ÷ 32
- Qmax 1.500 l/min • Pmax 350 bar

FLOW CONTROLS

Pressure compensated speed controls.
With or without LVDT transducers

- 2, 3 way • ISO sizes 06 ÷ 10
- Qmax 90 l/min • Pmax 210 bar



PROPORTIONAL VALVES

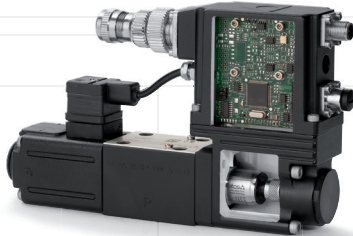

HIGH PERFORMANCE PRESSURE RELIEF

With pressure transducer for best accuracy and repeatability

- 2 way • ISO sizes 06 ÷ 32
- Q_{max} 600 l/min • P_{max} 350 bar

HIGH PERFORMANCE PRESSURE REDUCING

With pressure transducer for best accuracy and repeatability

- 2, 3 way • ISO sizes 06 ÷ 20
- Q_{max} 300 l/min • P_{max} 350 bar



PRESSURE RELIEF

Without pressure transducer

- 2 way • ISO sizes 06 ÷ 32
- Q_{max} 600 l/min • P_{max} 350 bar

PRESSURE REDUCING

Without pressure transducer

- 2, 3 way • ISO sizes 06 ÷ 20
- Q_{max} 300 l/min • P_{max} 350 bar



PRESSURE RELIEF CARTRIDGES

High flow with compact block design.

With or without pressure transducer

- 2 way • ISO sizes 16 ÷ 80
- Q_{max} 4.500 l/min • P_{max} 350 bar

PRESSURE REDUCING CARTRIDGES

High flow with compact block design.

With or without pressure transducer

- 2 way • ISO sizes 16 ÷ 40
- Q_{max} 800 l/min • P_{max} 350 bar

* All proportional valves are available with or without digital on-board drivers

PROPORTIONAL VALVES



**SAFETY
CERTIFIED**



SAFETY PROPORTIONALS

Directional valves integrating safety functions.
IEC 61508 & ISO 13849 certified

- 4/4, 4/3, 4/2 way
- ISO sizes 06 ÷ 35
- Qmax 3.500 l/min
- Pmax 350 bar



EMERGENCY HAND LEVERS

Auxiliary manual override to operate
the valve in case of emergency

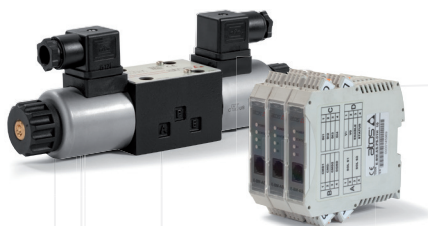

DIN-RAIL ELECTRONIC DRIVERS

For directional, flow and pressure valves.
Off-board executions suitable for electrical cabinet
installation in case of aggressive environments,
excessive temperatures and vibrations





AXIS & P/Q CONTROLS

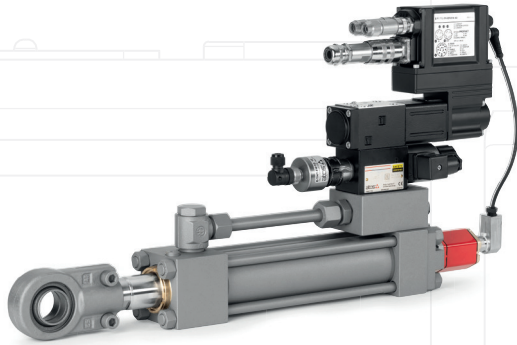

AXIS CONTROLS

Servoproportional directional valves with on-board digital axis card

- 4/4, 4/3 way • ISO sizes 06 ÷ 35
- Qmax 3.500 l/min • Pmax 350 bar

SERVOACTUATORS

Smart and compact units that integrate servocylinder and axis control valve to fully manage the motion cycle

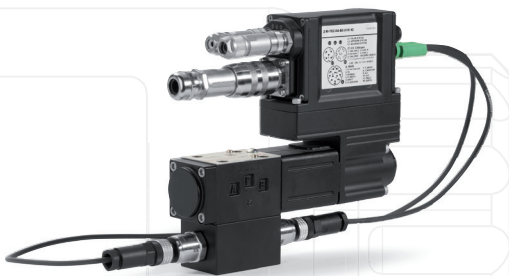

P/Q CONTROLS

Force or pressure controls for servoproportional and high performance directionals

- 4/4, 4/3 way • ISO sizes 06 ÷ 35
- Qmax 3.500 l/min • Pmax 350 bar
- 3 way • sizes 25 ÷ 80
- Qmax 5.000 l/min • Pmax 420 bar



P/Q AXIAL PISTON PUMPS

High dynamics & accurate P/Q electronic control with power limiting

- Pumps displacement 29 ÷ 140 cm³/rev
- Pmax 350 bar



DIN-RAIL AXIS CARDS

Off-board executions suitable for electrical cabinet installation. With or without valve drivers and P/Q control

ON-OFF VALVES

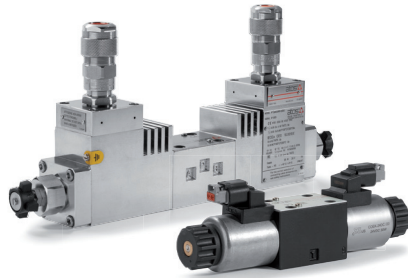

DIRECT SOLENOID DIRECTIONALS

DIN, AMP, Deutsch or lead wire connections.
Low leakage and/or low power 8/15 W executions

- 4/3, 4/2, 3/2 way • ISO sizes 06 ÷ 10
- Qmax 150 l/min • Pmax 350/420 bar

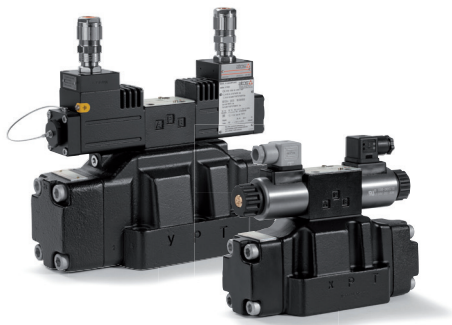

PILOTED SOLENOID DIRECTIONALS

DIN, AMP, Deutsch or lead wire connections

- 4/3, 4/2, 3/2 way • ISO sizes 10 ÷ 32
- Qmax 1.000 l/min • Pmax 350 bar



LEAK FREE

Directional solenoid valves with zero leakage

- 2, 3 way • sizes up to 1"5/16
- Qmax 300 l/min • Pmax 350 bar



MECHANICAL, HYDRAULIC, PNEUMATIC

Mechanical, hydraulic or pneumatic operated

- 4/3, 4/2, 3/2 way • ISO sizes 06 ÷ 32
- Qmax 1.000 l/min • Pmax 350 bar

ON-OFF VALVES



**SAFETY
CERTIFIED**



SAFETY DIRECTIONALS

With inductive sensors to monitor the spool position in compliance with Machine Directive 2006/42/EC

- 4/3, 4/2, 3/2 way • ISO sizes 06 ÷ 25
- Qmax 700 l/min • Pmax 350 bar

PRESSURE RELIEF

Subplate, screw-in and in-line executions

- 2 way • sizes up to ISO 32
- Qmax 600 l/min • Pmax 350 bar

PRESSURE REDUCING

- 2 way • ISO sizes 06 ÷ 32
- Qmax 400 l/min • Pmax 350 bar

SEQUENCE & UNLOADING

- 2 way • ISO sizes 06 ÷ 32
- Qmax 600 l/min • Pmax 350 bar

PRESSURE EQUIPMENT DIRECTIVE

Pressure relief valves PED certified. Subplate, screw-in and in-line executions

- 2 way • sizes up to ISO 32
- Qmax 600 l/min • Pmax 420 bar

**SAFETY
CERTIFIED**



INTRINSICALLY SAFE

The electronic barrier limits the power to 2 W

Directional solenoid valves

- 4/3, 4/2, 3/2 way • ISO sizes 06 ÷ 25
- Qmax 700 l/min • Pmax 350 bar

Leak free solenoid valves

- 2, 3 way • ISO size 06
- Qmax 12 l/min • Pmax 350 bar

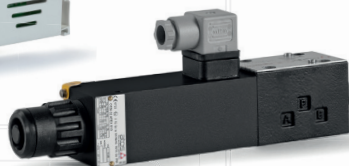

ON-OFF VALVES



HIGH FLOW CARTRIDGES

Directional, pressure, flow & check controls

- 2 way • ISO sizes 16 ÷ 100
- Qmax 9.000 l/min • Pmax 420 bar



SAFETY CARTRIDGES

With functional covers integrating inductive sensor to monitor poppet position

- 2 way • ISO sizes 16 ÷ 100
- Qmax 7.500 l/min • Pmax 420 bar

CHECK

Screw-in, subplate, in-line executions

- 2 way • sizes up to ISO 32
- Qmax 500 l/min • Pmax 350 bar



FLOW

Pressure compensated valves

- 2 way • ISO size 06
- Qmax 24 l/min • Pmax 250 bar

Throttle valves

- 2 way • sizes G 3/8 ÷ G 1 1/4
- Qmax 250 l/min • Pmax 400 bar

PRESSURE SWITCHES

Mechanical or electronic



MODULARS

Directional, flow, check, pressure relief, reducing, compensator and sequence controls

- 4/3, 4/2, 3/2 way • ISO sizes 06 ÷ 25
- Qmax 300 l/min • Pmax 350 bar

CYLINDERS

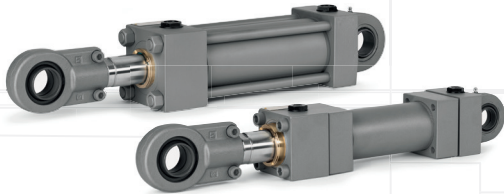

SQUARE HEADS

With tie-rods

- ISO 6020-2 • bore \varnothing 25 ÷ 200 mm
- Max speed 4 m/s • Pmax 250 bar

With counterflanges

- ISO 6020-2/3 • bore \varnothing 63 ÷ 400 mm
- Max speed 4 m/s • Pmax 250 bar

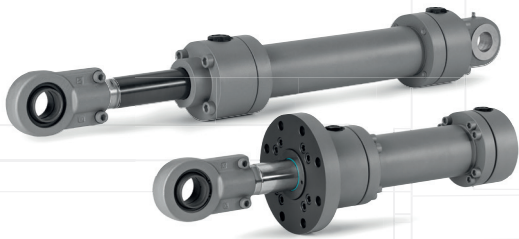

ROUND HEADS

With counterflanges

- ISO 6020-1 • bore \varnothing 40 ÷ 200 mm
- Max speed 4 m/s • Pmax 250 bar

With counterflanges

- ISO 6022 • bore \varnothing 50 ÷ 320 mm
- Max speed 4 m/s • Pmax 320 bar



SERVOCYLINDERS

Low friction with built-in position transducers. Safety executions integrate IEC 61508 certified transducers and/or rod locking systems



SPECIAL CYLINDERS

For demanding applications and harsh environments. On request: ceramic rod treatments, Geomet coatings or stainless steel executions

PUMPS



VANES

- Fixed displacements 10 ÷ 150 cm³/rev
- Pmax 210/300 bar

RADIAL PISTONS

- Fixed displacements 2 ÷ 25 cm³/rev
- Pmax 350/500 bar

AXIAL PISTONS

Pressure, flow, load sensing,
constant power or P/Q controls

- Variable displacements 29 ÷ 140 cm³/rev
- Pmax 350 bar

MULTIPLE

Modular assembly with fixed or variable
displacement pumps for flexible
hydraulic power management

FILTERS



IN LINE

- Filtration ratings F03 ÷ F10
- Qmax 340 l/min • Pmax 420 bar

RETURN LINE

- Filtration ratings F10 ÷ F25
- Qmax 550 l/min • Pmax 10 bar

SUCTION

- Filtration ratings W125
- Qmax 450 l/min

SYSTEMS

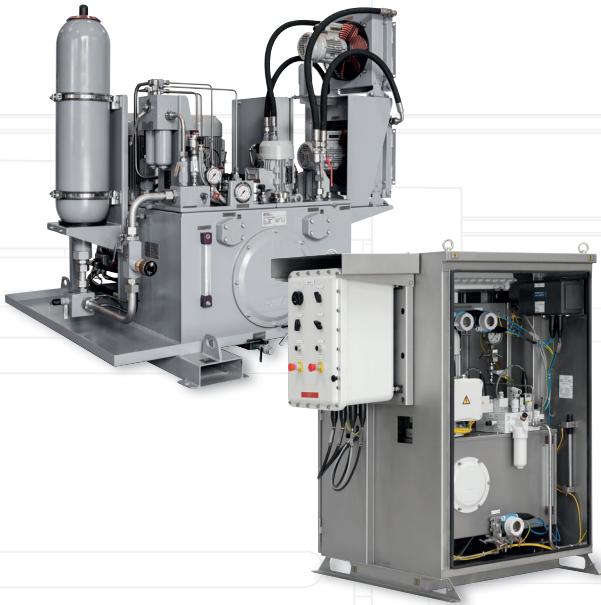

POWER UNITS

For industry, Oil&Gas, energy and marine sectors.
Engineered for 24/7 operation, remote control
and energy saving

Certified according to PED or Machine Directive,
conform to CE regulations

Stainless steel executions for operations in aggressive
environments or with water-based fluids.
Certified by ABS, BV, DNV GL, RMRS,
RINA, CCS, DEKRA, TÜV



BLOCKS

Standard or special executions
with CE, PED or safety certifications.
Cast iron, stainless steel,
carbon steel or aluminium alloy



MODULAR GROUPS

Modular compositions obtained
by assembling ISO standard
components

THE ATOS WAY

SOLUTION PROVIDER

Strong electrohydraulic experience makes Atos the ideal partner for the selection of innovative systems aimed at improving the machinery performance, also meeting special requirements

SERVICE CENTERS



Thanks to the worldwide network of official service centers, Atos provides high-level after-sales technical support. The highly qualified staff is trained to provide overhaul and repair services on the whole product range, using only original spare parts covered by warranty

SEMINARS & TRAININGS

Atos provides continuous technical training for internal personnel and customers through specific seminars covering the latest developments in electrohydraulics





"WE ARE ATOS,
WE ARE SMART"



ATOS. THE SMART ELECTROHYDRAULICS

atos 
the smart electrohydraulics



ATOS SPA
SESTO CALENDE - ITALY
WWW.ATOS.COM