

Proportional reducing valves

direct operated, ISO 4401 size 06 subplate mounting or M20 screw-in cartridge execution

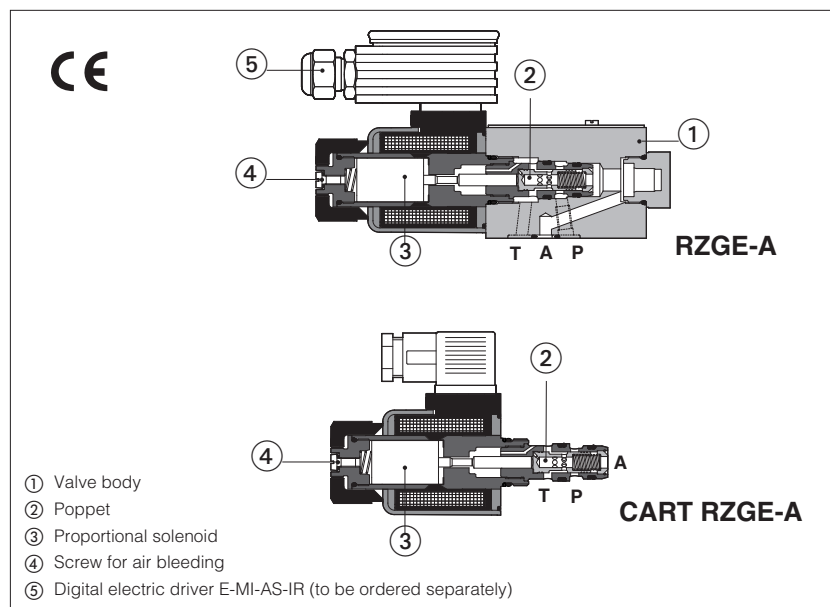

RZGE-A, CART RZGE-A

Open loop, poppet type direct operated proportional pressure reducing valves with proportional solenoids certified according to North American standard **CURus**.

They operate in association with electronic drivers, see section ②, which supply the proportional valves with proper current to align the valve regulation to the reference signal.

They are available in following executions:

RZGE: subplate mounting, ISO size 06

CART RZGE: M20 cartridge execution

The solenoid coils are plastic encapsulated with insulation class H and they are available with different nominal resistances depending to the voltage supply (12 VDC or 24 VDC) and to the electronic driver type, see section ② and ③.

Mounting surface RZGE: **ISO 4401 size 06**

Cavity CART RZGE: see section ②

Max flow = **12 l/min**

Max pressure = **210 bar**

1 MODEL CODE

RZGE	-	A	-	010	/	210	-	*	/	*	**	/	*
Proportional pressure relief valve												Seals material, see section ④:	
RZGE = subplate mounting												- = NBR	
CART RZGE = cartridge execution												PE = FKM	
												BT = HNBR	
												Series number	
A = without integral transducer													
Configuration:													
010 = regulation on port P, discharge in T													
Max regulated pressure:													
32 = 32 bar													
100 = 100 bar													
210 = 210 bar													
Coil voltage see section ② and ③:													
- = standard coil for 24V _{DC} Atos drivers													
6 = optional coil for 12V _{DC} Atos drivers													
18 = optional coil for low current drivers													
Coils with special connectors , see section ②													
- = omit for standard DIN connector													
J = AMP Junior Timer connector													
K = Deutsch connector													
S = Lead Wire connection													

2 ELECTRONIC DRIVERS

Drivers model	E-MI-AC (1)		E-MI-AS-IR (1)		E-BM-AC		E-BM-AS-PS		E-BM-AES	E-ME-AC
Type	analog		digital		analog		digital		digital	analog
Voltage supply (V _{DC})	12	24	12	24	12	24	12	24	24	24
Valve coil option	/6	std	/6	std	/6	std	/6	std	std	std
Format	DIN 43650 plug-in to solenoid				DIN 43700 UNDECAL		DIN-rail panel			EUROCARD
Data sheet	G010		G020		G025		G030		GS050	G035

(1) for **CART RZGE** the electronic driver may interfere with the manifold surface. Please check the installation dimensions at section ②

3 HYDRAULIC CHARACTERISTICS (based on mineral oil ISO VG 46 at 50 °C)

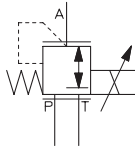
Hydraulic symbols	 RZGE-A CART RZGE-A		
Assembly position / location	Any position		
Subplate surface finishing (RZME)	Roughness index Ra 0,4 - flatness ratio 0,01/100 (ISO 1101)		
Ambient temperature	Standard = -20°C ÷ +70°C; /PE option = -20°C ÷ +70°C; /BT option = -40°C ÷ +70°C		
Coil code	Standard	option /6 optional coil to be used with Atos drivers with power supply 12 Vdc	option /18 optional coil to be used with electronic drivers not supplied by Atos, with power supply 24 Vdc and max current limited to 1A
Coil resistance R at 20°C	3 ÷ 3,3 Ω	2 ÷ 2,2 Ω	13 ÷ 13,4 Ω
Max. solenoid current	2,2 A	2,75 A	1 A
Max. power	30 Watt		
Protection degree (CEI EN-60529)	IP65		
Duty factor	Continuous rating (ED=100%)		
Certification	cURus North American Standard		

Max regulated pressure	32	100	210
Min. regulated pressure [bar]	0,8 (or actual value at T port)		
Max. pressure at port P [bar]	315		
Max. pressure at port T [bar]	210		
Max. flow [l/min]	12		
Response time 0-100% step signal (1) [ms] (depending on installation)	≤70		
Hysteresis [% of the max pressure]	≤ 1,5		
Linearity [% of the max pressure]	≤ 3		
Repeatability [% of the max pressure]	≤ 2		

Notes: above performance data refer to valves coupled with Atos electronic drivers, see section 2.

(1) Average response time values; the pressure variation in consequence of a modification of the reference input signal to the valve is affected by the stiffness of the hydraulic circuit: greater is the stiffness of the circuit, faster is the dynamic response.

4 SEALS AND HYDRAULIC FLUID

Seals, recommended fluid temperature	NBR seals (standard) = -20°C ÷ +60°C, with HFC hydraulic fluids = -20°C ÷ +50°C FKM seals (/PE option) = -20°C ÷ +80°C HNBR seals (/BT option) = -40°C ÷ +60°C, with HFC hydraulic fluids = -40°C ÷ +50°C		
Recommended viscosity	15 ÷ 100 mm ² /s - max allowed range 2.8 ÷ 500 mm ² /s		
Fluid contamination class	ISO 4406 class 21/19/16 NAS 1638 class 10, in line filters of 25 μm (β10 ≥75 recommended)		
Hydraulic fluid	Suitable seals type	Classification	Ref. Standard
Mineral oils	NBR, FKM, HNBR	HL, HLP, HLPD, HVL, HVLDP	DIN 51524
Flame resistant without water	FKM	HFDU, HFDR	ISO 12922
Flame resistant with water	NBR, HNBR	HFC	

Note: For other fluids not included in above table, consult our technical office

5 GENERAL NOTES

RZGE-A and CART RZGE-A proportional valves are CE marked according to the applicable Directives (e.g. Immunity/Emission EMC Directive and Low Voltage Directive).

Installation, wirings and start-up procedures must be performed according to the general prescriptions shown in table F003 and in the installation notes supplied with relevant components.

6 SOLENOID CONNECTIONS

SOLENOID POWER SUPPLY CONNECTOR	
PIN	Signal description
1	SUPPLY
2	SUPPLY
3	GND

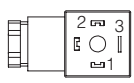

7 DIAGRAMS (based on mineral oil ISO VG 46 at 50 °C)

1 Regulation diagrams
with flow rate $Q = 1 \text{ l/min}$

Notes:

The presence of counter pressure at port T can affect the effective pressure regulation.

2 Pressure/flow diagrams
with reference pressure set with $Q = 1 \text{ l/min}$

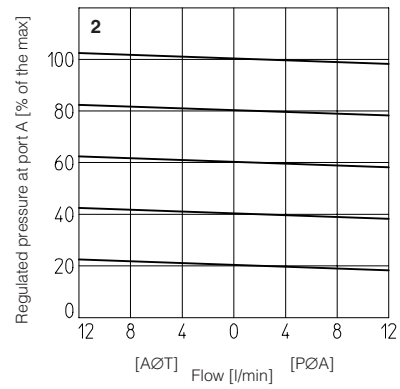
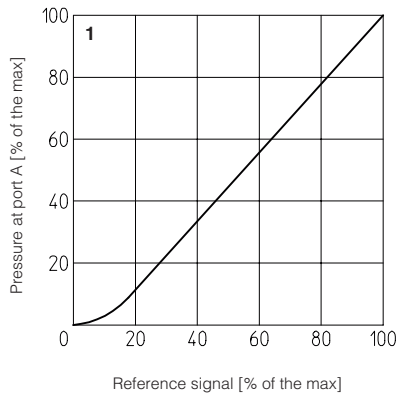

3-4 Pressure drop/flow diagram
with zero reference signal

3 = Pressure drops vs. flow P-A

4 = Pressure drops vs. flow A-T

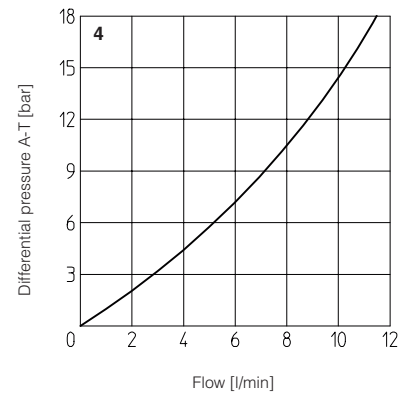
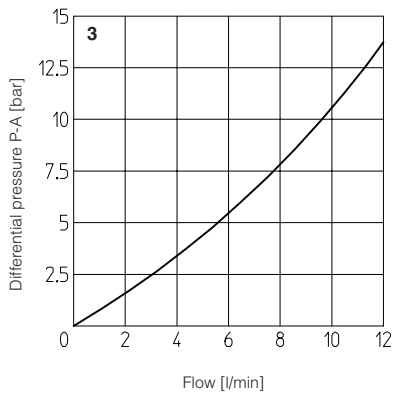

8 AIR BLEEDING

At the first valve commissioning the air eventually trapped inside the solenoid must be bled-off through the screw ① located at the rear side of the solenoid housing.

The presence of air may cause pressure instability and vibrations.

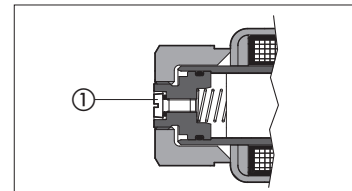

9 COILS TYPE WITH SPECIAL CONNECTORS

Options -J

Coil type COZEJ
AMP Junior Timer connector
Protection degree IP67

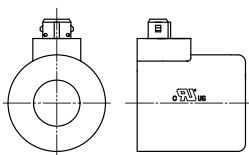

Options -K

Coil type COZEK
Deutsch connector, DT-04-2P male
Protection degree IP67

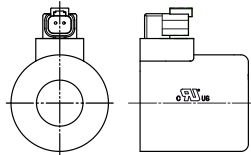

Options -S

Coil type COZES
Lead Wire connection
Cable length = 180 mm

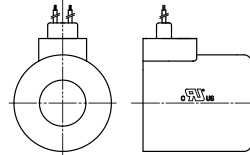

10 INSTALLATION DIMENSIONS [mm]

ISO 4401: 2005

Mounting surface: 4401-03-02-0-05 (see table P005)

(without port B)

Fastening bolts:

4 socket head screws M5X50 class 12.9

Tightening torque = 8 Nm

Seals: 3 OR 108

Ports P, T, A: $\varnothing = 5$ mm

view from X

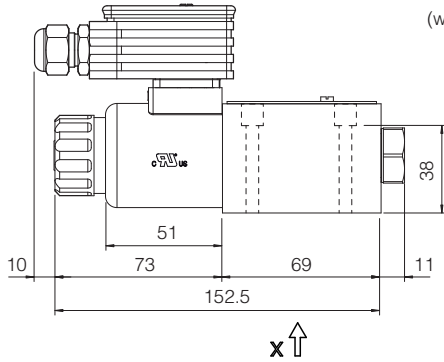
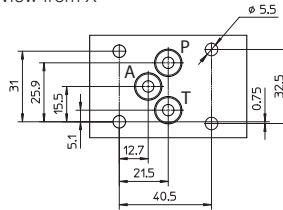

RZGE-A
(with digital driver E-MI-AS-IR)

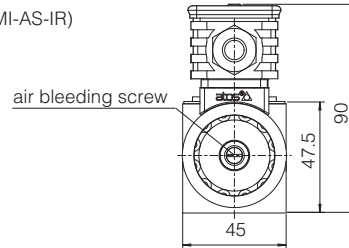

Mass: 1,6 Kg

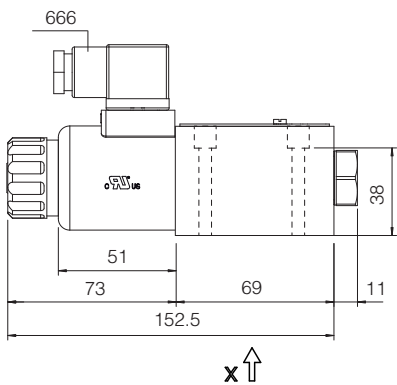

RZGE-A

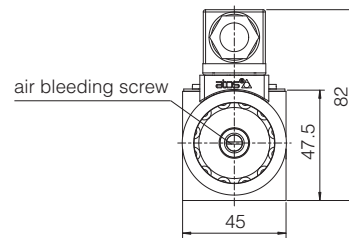

Mass: 1,5 Kg

Cavity dimensions
for **CART RZGE-A**

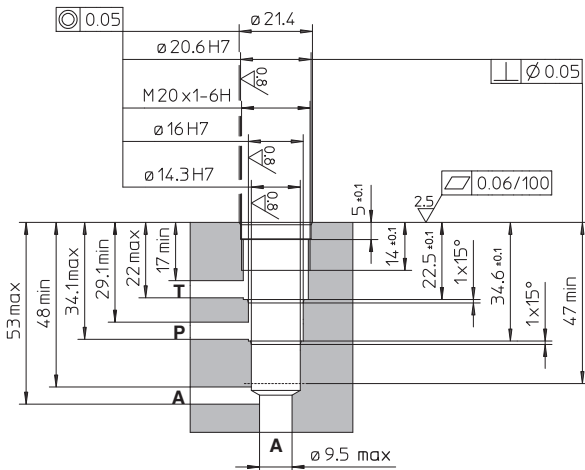

CART RZGE-A

CART RZGE-A
(with digital driver E-MI-AS-IR)

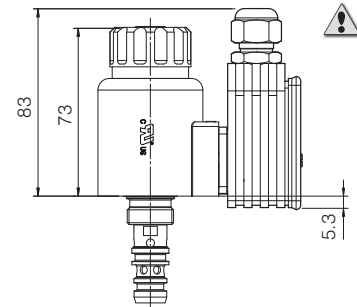
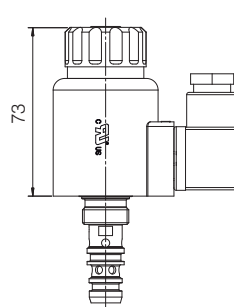

⚠ to be checked for eventual interference with the manifold surface

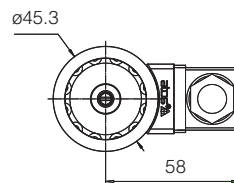

Mass: 0,6 Kg

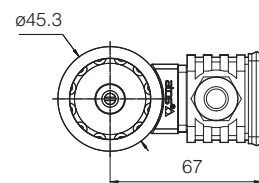

Mass: 0,7 Kg