

# Proportional directional valves

direct operated, open loop

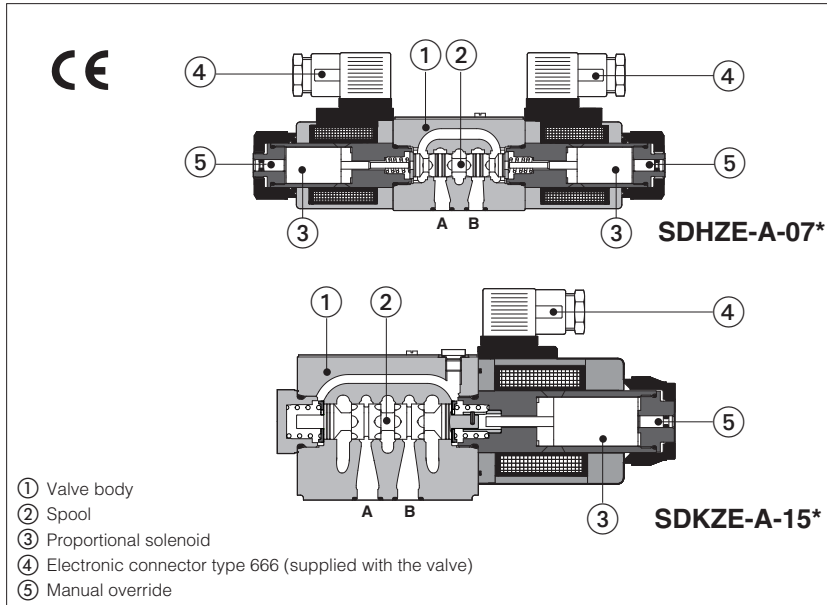

## SDHZE-A, SDKZE-A

Direct operated proportional directional valves without position transducer and with positive spool overlap for open loop directional controls and not compensated flow regulations

They operate in association with electronic drivers, see section 2, which supply the proportional valves with proper current to align the valve regulation to the reference signal.

The spools are available with linear **L**, progressive **S** or differential **D** flow characteristics.

The valve body is 3 chambers type for SDHZE and SDKZE.

The solenoid coils are available with different nominal resistances depending to the voltage supply to the driver (12 VDC or 24 VDC) and to the electronic driver characteristics, see section 2 and 3.

Mounting surface: **ISO 4401**

Size: **06** and **10**

Max flow: up to **70** and **160 l/min**

Max pressure: **350 bar** (SDHZE)  
**315 bar** (SDKZE)

## 1 MODEL CODE

<b>SDHZE</b>	-	<b>A</b>	-	<b>0</b>	<b>71</b>	-	<b>S</b>	<b>5</b>	/	*	-	*	/	*	**	/	*
<b>SDHZE</b> = size 06 <b>SDKZE</b> = size 10																	
<b>A</b> = open loop																	
<b>Valve size</b> - ISO 4401 <b>0</b> = size 06 (SDHZE) <b>1</b> = size 10 (SDKZE)																	
<b>Seals material, see section 4:</b> - = NBR <b>PE</b> = FKM <b>BT</b> = HNBR																	
Series number																	

## Configuration:

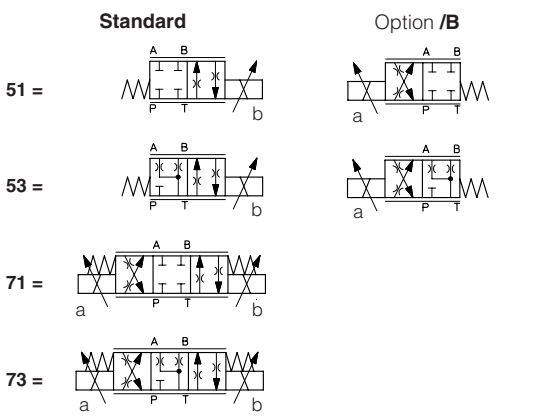

## Spool type - regulating characteristics:

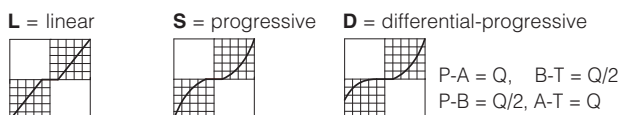

## Coil option (only for -A execution)

see section 2 and 3:

- = standard coil for 24V<sub>DC</sub> Atos drivers

**6** = optional coil for 12V<sub>DC</sub> Atos drivers

**18** = optional coil for 24V<sub>DC</sub> low current drivers **(1)**

Coils with special connectors, see section 10

- = omit for standard DIN connector

**J** = AMP Junior Timer connector

**K** = Deutsch connector

**S** = Lead Wire connection

## Hydraulic options

**B** = solenoid side of port A (only for valve configuration 5)

<b>Spool size:</b>	<b>14</b> (L)	<b>1</b> (L)	<b>3</b> (L,S,D)	<b>5</b> (L,S,D)
SDHZE =	1	4,5	17	28
SDKZE =	-	-	45	60
Nominal flow (l/min) at Δp 10 bar P-T				

**(1)** select valve's coil voltage /18 in case of electronic drivers not supply by Atos, with power supply 24V<sub>DC</sub> and with max current limited to 1A.

**2 ELECTRONIC DRIVERS** - see www.atos.com, catalog on-line, section "electronics" or KT master paper catalog

Drivers model	E-MI-AC		E-MI-AS-IR		E-BM-AC		E-BM-AS-PS		E-BM-AES	E-ME-AC
Type	analog		digital		analog		digital		digital	analog
Voltage supply (V <sub>DC</sub> )	12	24	12	24	12	24	12	24	24	24
Valve coil option	/6	std	/6	std	/6	std	/6	std	std	std
Format	DIN 43650 plug-in to solenoid				DIN 43700 UNDECAL		DIN-rail panel			EUROCARD
Data sheet	G010		G020		G025		G030		GS050	G035

**3 MAIN CHARACTERISTICS** - based on mineral oil ISO VG 46 at 50 °C

Assembly position	Any position					
Subplate surface finishing	Roughness index, Ra 0,4 flatness ratio 0,01/100 (ISO 1101)					
MTTFd valves according to EN ISO 13849	150 years, see KT technical table P007					
Ambient temperature range	<b>Standard</b> and <b>/PE</b> = -20°C ÷ +70°C,			<b>/BT</b> option = -40°C ÷ +60°C		
Storage temperature range	<b>Standard</b> and <b>/PE</b> = -20°C ÷ +80°C,			<b>/BT</b> option = -40°C ÷ +70°C		
Coil code	<b>SDHZE</b>			<b>SDKZE</b>		
	standard	option /6	option /18	standard	option /6	option /18
Coil resistance R at 20°C	3 ÷ 3,3 Ω	2 ÷ 2,2 Ω	13 ÷ 13,4 Ω	3,8 ÷ 4,1 Ω	2,2 ÷ 2,4 Ω	12 ÷ 12,5 Ω
Max. solenoid current	2,2 A	2,75 A	1 A	2,6 A	3,25 A	1,2 A
Max. power	30W			35W		
Insulation class	H (180°) Due to the occurring surface temperatures of the solenoid coils, the European standards ISO 13732-1 and EN982 must be taken into account					
Protection degree to DIN EN60529	<b>IP 65</b> (with connectors 666 correctly assembled)					
Duty factor	Continuous rating (ED=100%)					

Valve model	<b>SDHZE</b>				<b>SDKZE</b>	
Pressure limits [bar]	ports <b>P, A, B</b> = 350; <b>T</b> = 210				ports <b>P, A, B</b> = 315; <b>T</b> = 210	
Spool type and size	<b>L14</b>	<b>L1</b>	<b>S3, L3, D3</b>	<b>S5, L5, D5</b>	<b>S3, L3, D3</b>	<b>S5, L5, D5</b>
Nominal flow <b>(1)</b> [l/min]						
at Δp = 10 bar (P-T)	1	4,5	18	28	45	60
at Δp = 30 bar (P-T)	2	8	30	50	80	105
at Δp = 70 bar (P-T)	3	12	45	70	120	160
Response time <b>(2)</b> [ms]	< 30				< 40	
Hysteresis [%]	5 [% of max regulation]					
Repeatability [%]	± 1 [% of max regulation]					

**Notes:** above performance data refer to valves coupled with Atos electronic drivers, see section 2.  
the flow regulated by the directional proportional valves is not pressure compensated, thus it is affected by the load variations. To keep constant the regulated flow under different load conditions, Atos modular pressure compensators are available at www.atos.com (see KT table D150).

(1) For different Δp, the max flow is in accordance to the diagrams in sections 7.2 and 8.2

(2) 0-100% step signal

**4 SEALS AND HYDRAULIC FLUID** - for other fluids not included in below table, consult our technical office

Seals, recommended fluid temperature	NBR seals (standard) = -20°C ÷ +60°C, with HFC hydraulic fluids = -20°C ÷ +50°C FKM seals (/PE option) = -20°C ÷ +80°C HNBR seals (/BT option) = -40°C ÷ +60°C, with HFC hydraulic fluids = -40°C ÷ +50°C		
Recommended viscosity	20 ÷ 100 mm <sup>2</sup> /s - max allowed range 15 ÷ 380 mm <sup>2</sup> /s		
Fluid contamination class	ISO 4406 class 20/18/15 NAS 1638 class 9, in line filters of 10 μm (β10 ≥75 recommended)		
<b>Hydraulic fluid</b>	<b>Suitable seals type</b>	<b>Classification</b>	<b>Ref. Standard</b>
Mineral oils	NBR, FKM, HNBR	HL, HLP, HLPD, HVL, HVLDP	DIN 51524
Flame resistant without water	FKM	HFDR, HFDR	ISO 12922
Flame resistant with water	NBR, HNBR	HFC	

**5 GENERAL NOTES**

SDHZE and SDKZE proportional valves are CE marked according to the applicable Directives (e.g. Immunity/Emission EMC Directive and Low Voltage Directive).

**6 CONNECTIONS**

SOLENOID POWER SUPPLY CONNECTOR TYPE 666		
PIN	Signal description	
1	SUPPLY	
2	SUPPLY	
3	GND	

**7 DIAGRAMS FOR SDHZE** (based on mineral oil ISO VG 46 at 50 °C)

**7.1 Regulation diagrams**

- 1 = linear spool L14      3 = linear spool L3      5 = linear spool L5  
 2 = linear spool L1      4 = progressive spool S3, D3      6 = progressive spool S5, D5

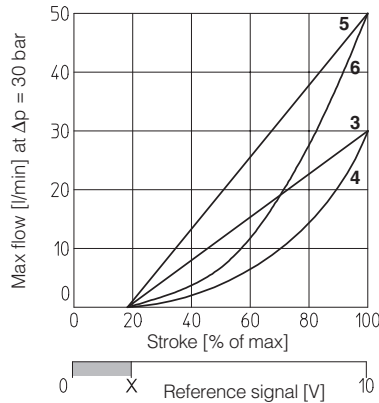
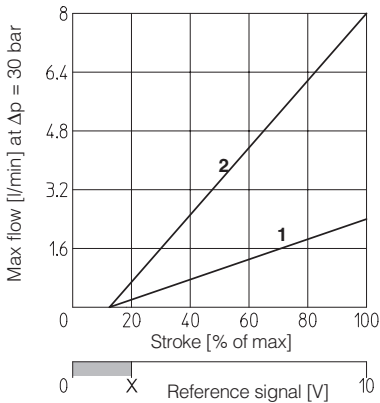

X = Threshold for bias activation depending to the valve type and amplifier type

**7.2 Operating limits**

- 7 = spool L14      9 = spool L3, S3, D3  
 8 = spool L1      10 = spool L5, S5, D5

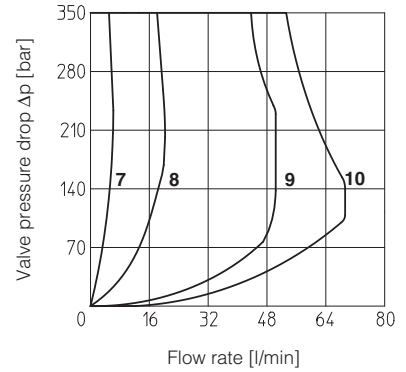

**8 DIAGRAMS FOR SDKZE** (based on mineral oil ISO VG 46 at 50 °C)

**8.1 Regulation diagrams**

- 1 = linear spool L3  
 2 = progressive spool S3, D3  
 3 = linear spool L5  
 4 = progressive spool S5, D5

**8.2 Operating limits**

- 1 = spool L3, S3, D3  
 2 = spool L5, S5, D5

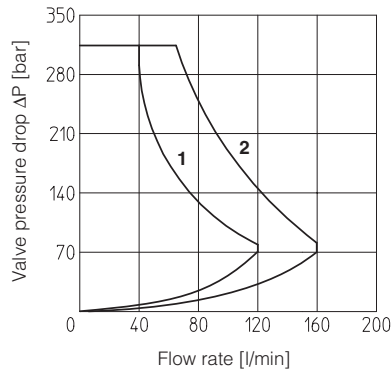
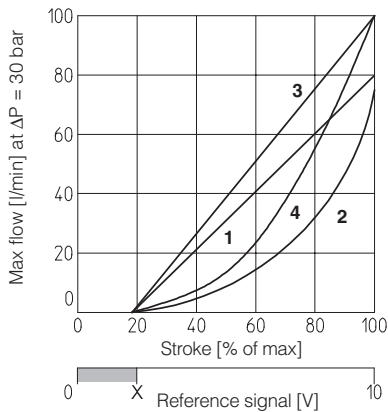

X = Threshold for bias activation depending to the valve type and amplifier type

**9 OPERATION AS THROTTLE VALVE**

Single solenoid valves (SDHZE-A-051 - SDKZE-A-151) can be used as simple throttle valves:  
 Pmax = 210 bar

Max flow Δp= 30bar [l/min]	SPOOL TYPE					
	L14	L1	L3	S3	L5	S5
SDHZE	4	16	60		100	
SDKZE	-	-	120		150	

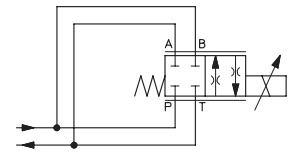

**10 COILS WITH SPECIAL CONNECTORS**

**Options -J**

- Coil type COZEJ (SDHZE)
- Coil type CAZEJ (SDKZE)
- AMP Junior Timer connector
- Protection degree IP67

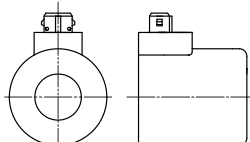

**Options -K**

- Coil type COZEK (SDHZE)
- Coil type CAZEK (SDKZE)
- Deutsch connector, DT-04-2P male
- Protection degree IP67

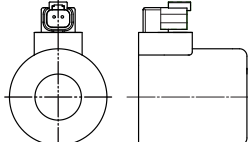

**Options -S**

- Coil type COZES (SDHZE)
- Coil type CAZES (SDKZE)
- Lead Wire connection
- Cable length = 180 mm

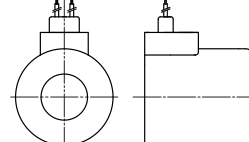

11 INSTALLATION DIMENSIONS FOR SDHZE and SDKZE [mm]

**SDHZE**

ISO 4401: 2005

Mounting surface: 4401-03-02-0-05

Fastening bolts: 4 socket head screws M5x30 class 12.9

Tightening torque = 8 Nm

Seals: 4 OR 108

Ports P,A,B,T:  $\varnothing = 7.5$  mm (max)

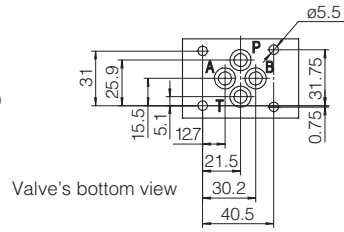

**P** = PRESSURE PORT  
**A, B** = USE PORT  
**T** = TANK PORT

**SDHZE-A-05**

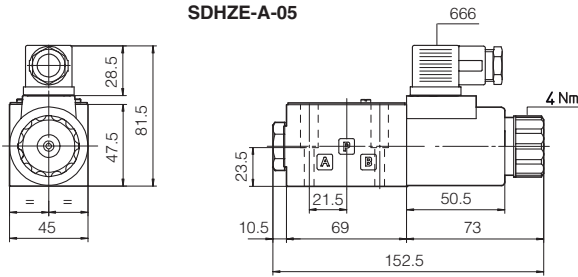

Mass: 1,5 kg

**SDHZE-A-05 /B**

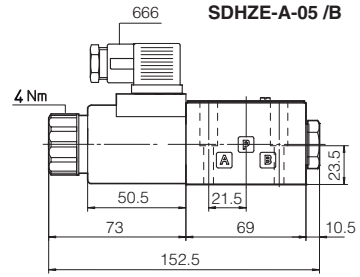

**SDHZE-A-07**

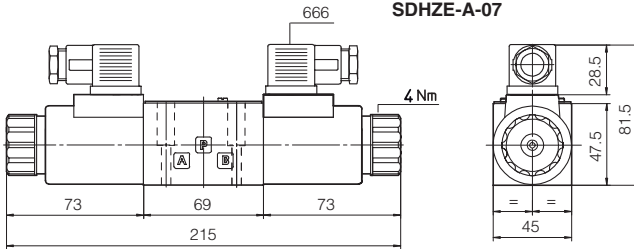

Mass: 2 kg

**SDKZE**

ISO 4401: 2005

Mounting surface: 4401-05-04-0-05 (see table P005)

Fastening bolts: 4 socket head screws M6x40 class 12.9

Tightening torque = 15 Nm

Seals: 5 OR 2050

Diameter of ports A, B, P, T:  $\varnothing 11,2$  mm (max)

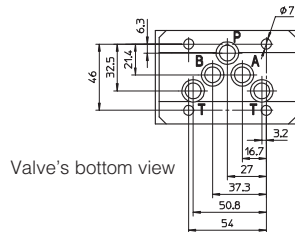

**P** = PRESSURE PORT  
**A, B** = USE PORT  
**T** = TANK PORT

**SDKZE-A-15**

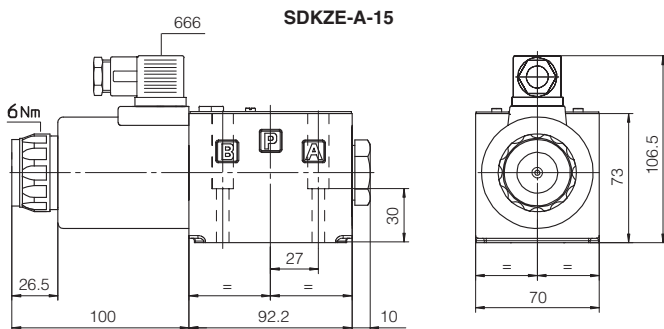

Mass: 4,5 kg

**SDKZE-A-15 /B**

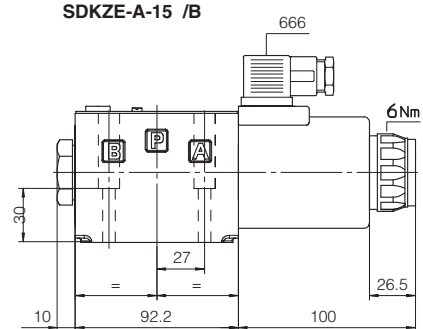

**SDKZE-A-17**

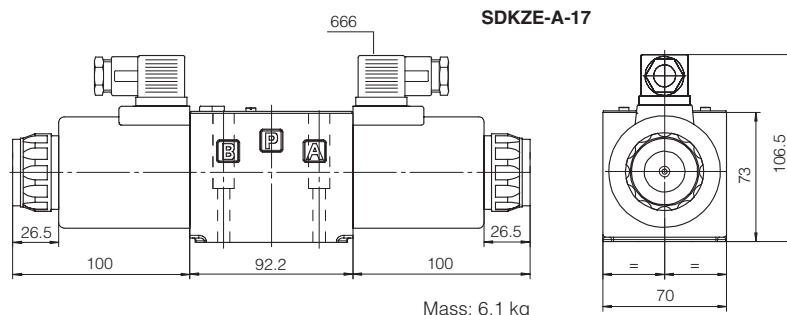

Mass: 6,1 kg