

# Solenoid directional valves P<sub>max</sub> 420 bar

direct operated, ISO 4401 size 06 and size 10

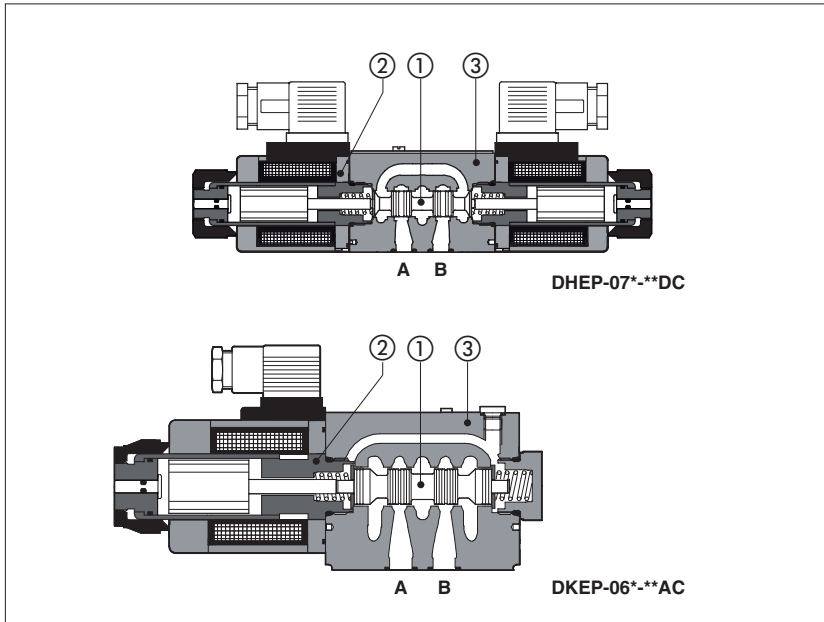

### DHEP; DKEP

Spool type, direct operated solenoid valves with max pressure up to 420 bar for heavy duty applications.

They are equipped with threaded solenoids certified according the North American standard **cUus**

Single and double solenoid valves are available in two or three position configurations and with a wide range of interchangeable spools ①, see section ②.

Solenoids ② are made by:

- wet type screwed tube, different for AC and DC power supply, with integrated manual override pin c
- interchangeable coils, specific for AC or DC power supply, easily replaceable without tools - see section 5 for available voltages

Standard coils protection IP65 (once correctly assembled with relevant electric connectors).

The valve body ③ is made by high strength cast iron.

Mounting surface ISO 4401 size **06** and **10**

Max flow up to **80** and **150** l/min

Max pressure: **420** bar

## 1 MODEL CODE

<b>DHEP - 0</b>	<b>63</b>	<b>1/2</b>	<b>/A</b>	<b>X</b>	<b>24 DC</b>	<b>**</b>	<b>/*</b>
Directional control valves <b>DHEP-0</b> = Size 06 <b>DKEP-1</b> = Size 10							Seals material, see sect. ③, ④: - = NBR <b>PE</b> = FKM <b>BT</b> = HNBR
Valve configuration, see table ② <b>61</b> = single solenoid, center plus external position, spring centered <b>63</b> = single solenoid, 2 external positions, spring offset <b>67</b> = single solenoid, center plus external position, spring offset <b>71</b> = double solenoid, 3 positions, spring centered <b>75</b> = double solenoid, 2 external positions, with detent							Series number
Spool type, see table ②.							Voltage code, see section ⑥
Options, see note 1 at section ⑤				<b>00-AC</b> = AC solenoids without coils <b>00-DC</b> = DC solenoids without coils <b>X</b> = without connector See note 2 at section ⑤ for available connectors, to be ordered separately Coils with special connectors, see section ⑦ <b>XJ</b> = AMP Junior Timer connector <b>XK</b> = Deutsch connector <b>XS</b> = Lead Wire connection			

## 2 CONFIGURATIONS and SPOOLS

Configurations	Spools	Configurations	Spools
<p><b>61</b></p> <p><b>61/A</b></p> <p><b>67</b></p> <p><b>67/A</b></p> <p><b>71</b></p>	<p>0</p> <p>1</p> <p>2</p> <p>3</p> <p>4</p> <p>5</p> <p>6</p> <p>7</p> <p>8</p> <p>90</p> <p>09</p> <p>91</p> <p>19</p> <p>93</p> <p>39</p> <p>94</p> <p>49</p> <p>16</p> <p>17</p> <p>58</p> <p>1/9</p> <p>only for configuration 71</p>	<p><b>63</b></p> <p><b>63/A</b></p> <p><b>75</b></p>	<p>0/2</p> <p>1/2</p> <p>2/2</p>

### 3 MAIN CHARACTERISTICS OF DHE\* DIRECTIONAL VALVES

Assembly position / location	Any position
Subplate surface finishing	Roughness index Ra 0,4 - flatness ratio 0,01/100 (ISO 1101)
MTTFd values according to EN ISO 13849	300 years, for further details see technical table P007
Ambient temperature	from -30°C to +70°C (standard seals) -20°C to +70°C (/PE seals) -40°C to +60°C (/BT seals)
Flow direction	As shown in the symbols of section 2
<b>Operating pressure</b>	Ports P,A,B: <b>420</b> bar; Port T <b>210</b> bar for DC version; <b>160</b> bar for AC version
Rated flow	See diagrams Q/Δp at section 8, 12
<b>Maximum flow</b>	<b>DHEP 80 l/min, DKEP 150 l/min</b> , see operating limits at section 9, 13

#### 3.1 Coils characteristics

Insulation class	<b>H</b> (180°C) for DC coils <b>F</b> (155°C) for AC coils Due to the occurring surface temperatures of the solenoid coils, the European standards EN ISO 13732-1 and EN ISO 4413 must be taken into account
Protection degree to DIN EN 60529	<b>IP 65</b> (with connectors 666, 667, 669 or E-SD correctly assembled)
Relative duty factor	100%
Supply voltage and frequency	See electric feature 5
Supply voltage tolerance	± 10%
Certification	<b>cURus</b> North American Standard

### 4 SEALS AND HYDRAULIC FLUID

Seals, recommended temperature fluid	NBR seals = -20°C ÷ +60°C, with HFC hydraulic fluids = -20°C ÷ +50°C FKM seals = -20°C ÷ +80°C HNBR seals = -40°C ÷ +60°C, with HFC hydraulic fluids = -40°C ÷ +50°C		
Recommended viscosity	20 ÷ 100 mm <sup>2</sup> /s - max allowed range 15 ÷ 380 mm <sup>2</sup> /s		
Fluid contamination class	ISO 4406 class 20/18/15 NAS 1638 class 9, in line filters of 10 μm (β10 ≥75 recommended)		
<b>Hydraulic fluid</b>	<b>Suitable seals type</b>	<b>Classification</b>	<b>Ref. Standard</b>
Mineral oils	NBR, FKM, HNBR	HL, HLP, HLPD, HVLP, HVLPD	DIN 51524
Flame resistant without water	FKM	HFDU, HFDR	ISO 12922
Flame resistant with water	NBR, HNBR	HFC	

**Note:** For other fluids not included in above table, consult our technical office

### 5 NOTES FOR DHEP AND DKEP

#### 1 Options

- A** = Solenoid mounted at side of port B (only for single solenoid valves). In standard versions, solenoid is mounted at side of port A.  
**WP** = prolonged manual override protected by rubber cap.

 The manual override operation can be possible only if the pressure at T port is lower than 50 bar.

**WPD/HE-DC** = (only for DHEP-DC) manual override with detent, to be ordered separately, see tab. K150

**WPD/KE-DC** = (only for DKEP-DC) manual override with detent, to be ordered separately, see tab. K150

#### 2 Type of electric/electronic connector DIN 43650, to be ordered separately

- 666** = standard connector IP-65, suitable for direct connection to electric supply source.  
**667** = as 666, but with built-in signal led.  
**669** = with built-in rectifier bridge for supplying DC coils by alternate current (AC 110V and 230V - I<sub>max</sub> 1A).  
**E-SD** = **(only for DHEP)** electronic connector which eliminates electric disturbances when solenoid valves are de-energized.

#### 3 Spools for DHEP

- spools type **0** and **3** are also available as **0/1** and **3/1** with restricted oil passages in central position, from user ports to tank.
- spools type **1, 4, 5** and **58** are also available as **1/1, 4/8, 5/1** and **58/1**. They are properly shaped to reduce water-hammer shocks during the switching.
- spools type **1, 1/2, 3, 8** are available as **1P, 1/2P, 3P, 8P** to limit valve internal leakages.
- Other types of spools can be supplied on request.

#### Spools for DKEP

- spools type **0** and **3** are also available as **0/1** and **3/1** with restricted oil passages in central position, from user ports to tank.
- spools type **1** is also available as **1/1**, properly shaped to reduce the water-hammer shocks during the switching.
- spool type **1/9** has closed center in rest position but it avoids the pressurization of A and B ports due to the internal leakages.
- other types of spools can be supplied on request.

**6 ELECTRIC FEATURES**

External supply nominal voltage ± 10%	Voltage code	Type of connector	Power consumption (2)	Code of spare coil	
				DHEP	DKEP
12 DC	<b>12 DC</b>	666 or 667	30 W (DHEP) 36 W (DKEP)	COE-12DC	CAE-12DC
14 DC	<b>14 DC</b>			COE-14DC	CAE-14DC
24 DC	<b>24 DC</b>			COE-24DC	CAE-24DC
28 DC	<b>28 DC</b>			COE-28DC	CAE-28DC
110 DC	<b>110 DC</b>			COE-110DC	CAE-110DC
125 DC	<b>125 DC</b>			COE-125DC	-
220 DC	<b>220 DC</b>		COE-220DC	CAE-220DC	
110/50/60 AC	<b>110/50/60 AC</b>		58 VA (DHEP) 85 VA (DKEP) (3)	COE-110/50/60AC (1)	CAE-110/50/60AC (1)
230/50/60 AC	<b>230/50/60 AC</b>			COE-230/50/60AC (1)	CAE-230/50/60AC (1)
115/60 AC	<b>115/60 AC</b>			COE-115/60AC	CAE-115/60AC
230/60 AC	<b>230/60 AC</b>	COE-230/60AC		CAE-230/60AC	
110/50/60 AC	<b>110 RC</b>	669	30 W (DHEP)	COE-110DC	CAE-110DC
230/50/60 AC	<b>220 RC</b>			COE-220DC	CAE-220DC
110/50/60 AC	<b>110 DC</b>		36 W (DKEP)	COE-110DC	CAE-110DC
230/50/60 AC	<b>220 DC</b>			COE-220DC	CAE-220DC

(1) In case of 60 Hz voltage frequency the performances are reduced by 10÷15% and the power consumption is 80 VA for DHEP and 90 VA for DKEP.

(2) Average values based on tests performed at nominal hydraulic condition and ambient/coil temperature of 20°C.

(3) When solenoid is energized, the inrush current is approx 3 times the holding current. Inrush current values correspond to a power consumption of about 280 VA for DHEP and 320 VA for DKEP.

**7 COIL WITH SPECIAL CONNECTORS** only for voltage supply **12, 14, 24, 28 Vdc**

**COIL COE for DHEP**

AMP Junior timer connector	Deutsch connector DT-04-2P	Lead Wire connection
<p><b>Options -XJ</b>, coil type COEJ AMP Junior Timer connector Protection degree IP67</p>	<p><b>Options -XK</b>, coil type COEK Deutsch connector, DT-04-2P male Protection degree IP67</p>	<p><b>Options -XS</b>, coil type COES Lead Wire connection Cable length = 180 mm</p>

**COIL CAE for DKEP**

AMP Junior timer connector	Deutsch connector DT-04-2P	Lead Wire connection
<p><b>Options -XJ</b> Coil type CAEJ AMP Junior Timer connector Protection degree <b>IP67</b></p>	<p><b>Options -XK</b> Coil type CAEK Deutsch connector DT-04-2P male Protection degree <b>IP67</b></p>	<p><b>Options -XS</b> Coil type CAES Lead Wire connection Cable length = 180 mm</p>

Note: for the electric characteristics refer to standard coils features - see section 6

**8 Q/ΔP DIAGRAMS** based on mineral oil ISO VG 46 at 50°C

Flow direction Spool type	Flow direction				
	P→A	P→B	A→T	B→T	P→T
0, 0/1	A	A	C	C	D
1, 1/1	D	C	C	C	
3, 3/1	D	D	A	A	
4, 4/8, 5, 5/1, 58, 58/1 09, 90, 91, 93, 94	F	F	G	C	E
1/2, 0/2	D	D	D	D	
6, 7	D	D	D	D	
8	A	A	E	E	
2	D	D			
2/2	F	F			

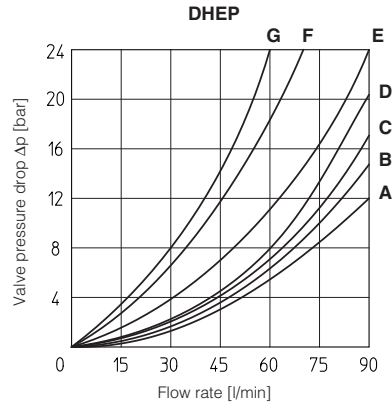

**9 OPERATING LIMITS** based on mineral oil ISO VG 46 at 50°C

The diagrams have been obtained with warm solenoids and power supply at lowest value ( $V_{nom} - 10\%$ ). The curves refer to application with symmetrical flow through the valve (i.e. P→A and B→T). In case of asymmetric flow and if the valves have the devices for controlling the switching times the operating limits must be reduced.

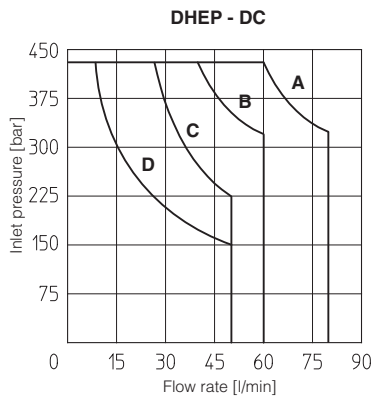
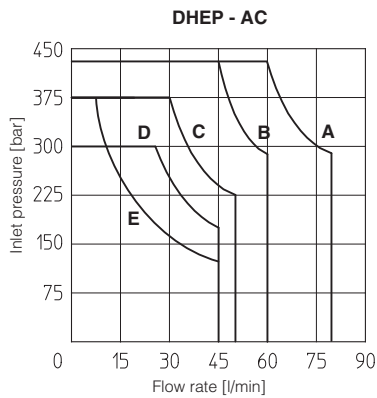

Curve	Spool type	
	AC	DC
A	1, 1/2, 8	0, 0/1, 1, 1/2, 3, 8
B	0, 0/1, 0/2, 1/1	0/2, 1/1, 6, 7
C	3, 3/1	3/1, 4, 4/8, 5, 5/1, 19, 39, 58, 90, 91, 93, 94
D	4, 4/8, 5, 5/1, 6, 7, 19, 39, 58, 91, 93, 94	2, 2/2
E	2, 2/2	-

**10 SWITCHING TIMES** (average values in msec)

Valve	Switch-on AC	Switch-off AC	Switch-on DC	Switch-off DC
DHEP	10 - 25	20 - 40	30 - 50	15 - 25

Test conditions:

- 36 l/min; 150 bar
- nominal voltage
- 2 bar of counter pressure on port T
- mineral oil: ISO VG 46 at 50°C.

The elasticity of the hydraulic circuit and the variations of the hydraulic characteristics and temperature affect the response time.

**11 SWITCHING FREQUENCY**

Valve	AC (cycles/h)	DC (cycles/h)
DHEP + 666 / 667	7200	15000

**12 Q/ΔP DIAGRAMS** based on mineral oil ISO VG 46 at 50°C

Flow direction Spool type	P→A	P→B	A→T	B→T	P→T	B→A
0, 0/1, 0/2, 2/2	A	A	B	B		
1, 1/1, 1/3, 6, 8	A	A	D	C		
3, 3/1, 7	A	A	C	D		
4	B	B	B	B	F	
5	A	B	C	C	G	
1/2	B	C	C	B		
2/7	D			F		
5/7	B			A	E	
19	A	D	C			H

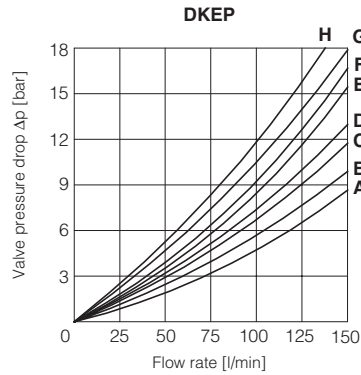

**13 OPERATING LIMITS** based on mineral oil ISO VG 46 at 50°C

The diagrams have been obtained with warm solenoids and power supply at lowest value ( $V_{nom} - 10\%$ ). The curves refer to application with symmetrical flow through the valve (i.e. P→A and B→T). In case of asymmetric flow and if the valves have the devices for controlling the switching times the operating limits must be reduced.

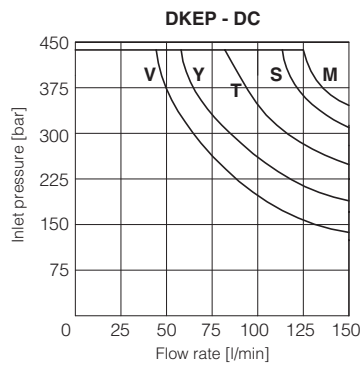
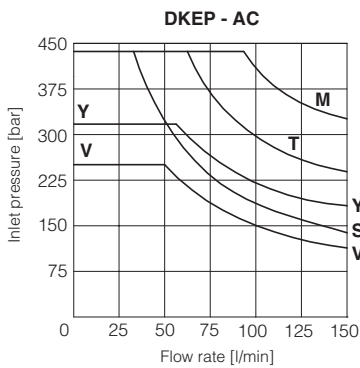

Curve	Spool type	
	AC	DC
M	0/1, 5/7, 1/3	0, 0/1, 1, 1/1, 3, 3/1, 1/2, 0/2, 8
S	2/7, 4, 5, 19	1/3, 5/7, 6, 7
Y	1, 1/2, 0/2	4, 5, 2/7
V	6, 7, 8, 2/2	2/2
T	0, 1/1, 3, 3/1	19
U	-	4, 5
Z	-	0/1, 1/1, 3/1

**14 SWITCHING TIMES** (average values in msec)

Valve	Switch-on AC	Switch-on DC	Switch-off AC	Switch-off DC
DKEP + 666 / 667	40	60	25	35

Test conditions:

- 50 l/min; 150 bar
- nominal supply voltage
- 2 bar of back pressure on port T
- mineral oil ISO VG 46 at 50°C

The elasticity of the hydraulic circuit and the variations of the hydraulic characteristics and temperature affect the response time.

**15 SWITCHING FREQUENCY**

Valve	AC (cycles/h)	DC (cycles/h)
DKEP + 666 / 667	7200	15000

16 INSTALLATION DIMENSIONS [mm]

ISO 4401: 2005

Mounting surface: 4401-03-02-0-05  
 Fastening bolts: 4 socket head screws:  
 M5x30 class 12.9  
 Tightening torque = 8 Nm  
 Seals: 4 OR 108  
 Ports P,A,B,T:  $\varnothing = 7.5$  mm (max)

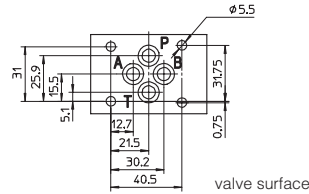

P = PRESSURE PORT  
 A, B = USE PORT  
 T = TANK PORT

DHEP-06(DC)

Option /WP

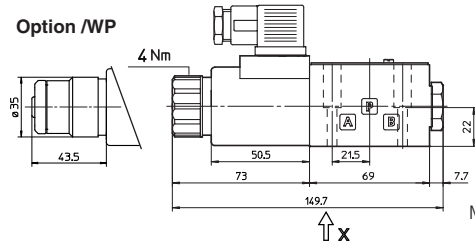

Mass: 1,75 kg

DHEP-07(DC)

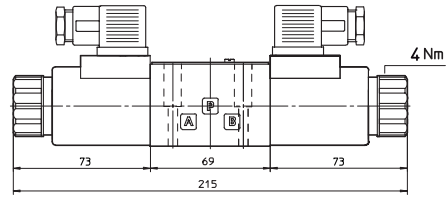

Mass: 2 kg

DHEP-06(AC)

Option /WP

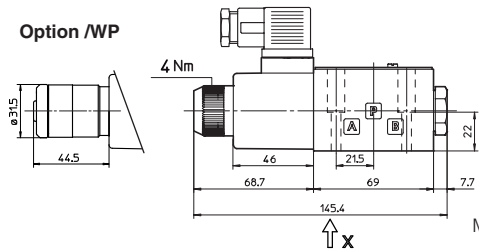

Mass: 1,6 kg

DHEP-07(AC)

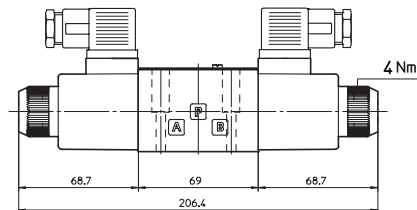

Mass: 1.9 kg

ISO 4401: 2005

Mounting surface according to 4401-05-05-0-05  
 (without X and Y ports)

Fastening bolts:  
 4 socket head screws M6x40 class 12.9  
 Tightening torque = 15 Nm  
 Seals: 5 OR 2050  
 Ports P,A,B,T:  $\varnothing = 11.5$  mm (max)

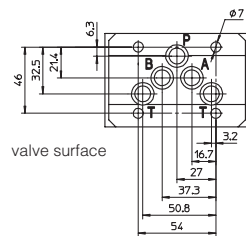

P = PRESSURE PORT  
 A, B = USE PORT  
 T = TANK PORT

For the max pressures on ports, see section 3

DKEP-16\*-DC

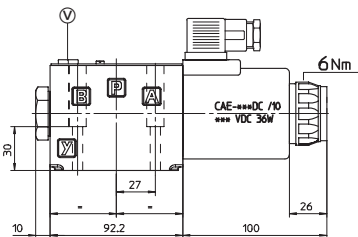

Mass: 4,2 kg

Option /WP

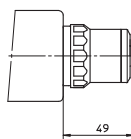

DKEP-17\*-DC

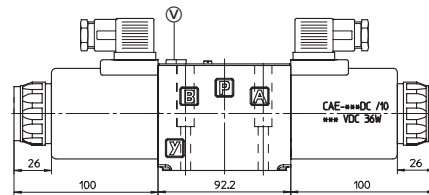

Mass: 5,7 kg

DKEP-16\*-AC

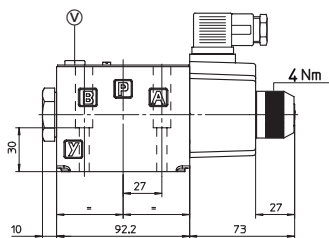

Mass: 3,6 kg

Option /WP

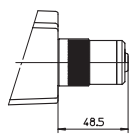

DKEP-17\*-AC

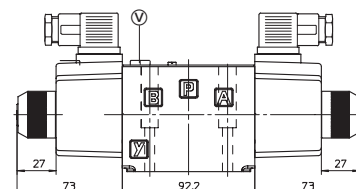

Mass: 4,3 kg

Overall dimensions refer to valves with connectors type 666