

Solenoid directional valves type DHAL8 and DHWL8

direct operated, ISO 4401 size 06, **ex-proof or intrinsically safe, low leakage execution**

Available only on request

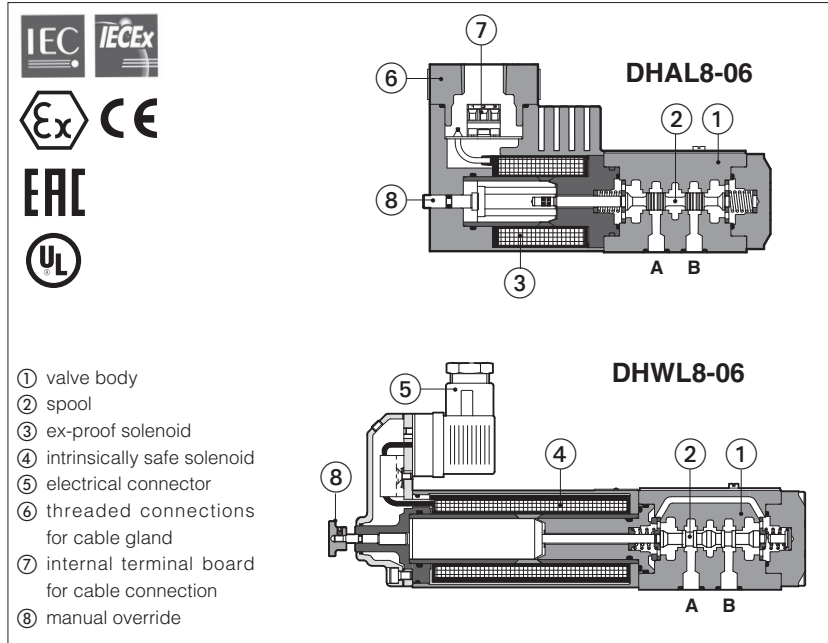

On-off directional valves size 06 in **low leakage execution**, equipped with **Ex certified solenoids**, ideal for hydraulic systems assisted by accumulators operating in hazardous environments.

They are equipped with spool diameter 8 mm accurately coupled to the body, granting very low internal leakages, see section 18

Valves models:

DHAL8: equipped with ex-proof solenoids, protection mode **Ex-d**, available with following certifications:

Multicertification ATEX, IECEx, EAC for gas group II and dust category 2, or

Multicertification ATEX and IECEx for gas group I (mining), or

cULus North American certification for gas group C&D

DHWL8: equipped with intrinsically safe solenoids, protection mode **Ex-ia (ib)**, certified ATEX or IECEx for gas group II or group I (mining)

Mounting surface: **ISO 4401 size 06**

Max flow: DHAL8 = **40 l/min**

DHWL8 = **20 l/min**

Max pressure: DHAL8 = **350 bar**

DHWL8 = **250 bar**

1 MODEL CODE OF EX-PROOF VERSION

DHAL8	/	*	-	0	63	1/2	/	GK	/	*	24DC	**	/	*
<p>Solenoid valve, size 06, low leakage, ex-proof execution</p> <p>Certification type: Multicertification ATEX, IECEx, EAC: - = omit for Group II M = Group I (mining) North American Certification: UL = cULus</p> <p>Valve size (ISO 4401) 0 = 06</p> <p>Valve configuration, see section 7</p> <p>Spool type, see section 7</p> <p>Solenoid threaded connection for cable gland fitting: GK = GK-1/2" ISO/UNI-6125 (tapered) - not for UL NPT = 1/2" NPT ANSI B2.1 (tapered) M = M20x1,5 UNI-4535 (6H/6g) - not for UL</p> <p>Seals material, see section 9: - = NBR PE = FKM BT = HNBR</p> <p>Series number</p> <p>Voltage code - see section 3</p>														

Options:

- A** = solenoid at side of port B (for single solenoid valves)
- O** = horizontal cable entrance
- WP** = prolonged manual override protected by metallic cap

2 MODEL CODE OF INTRINSICALLY SAFE VERSION

DHWL8	/	*	-	0	63	1/2	/	*	6	**	/	*
<p>Solenoid valve, size 06, low leakage, intrinsically safe execution</p> <p>Certification type: - = omit for ATEX Group II M = ATEX Group I (mining) IE = IECEx Group II IEM = IECEx Group I (Mining)</p> <p>Valve size (ISO 4401) 0 = 06</p> <p>Valve configuration, see section 7</p> <p>Spool type, see section 7</p> <p>Seals material, see section 9: - = NBR PE = FKM BT = HNBR</p> <p>Series number</p> <p>Connector type DIN 43650, see section 11</p>												

Options:

- A** = solenoid at side of port B (for single solenoid valves)
- WP** = prolonged manual override

The manual override operation can be possible only if the pressure at T port is lower than 50 bar

3 EX-PROOF SOLENOIDS: MAIN DATA

Certification	Multicertification for Group II	Multicertification for Group I	Certification cULus
Type examination certificate (1)	CESI 02 ATEX 014 IECEX CES 10.0010x	CESI 03 ATEX 057x IECEX CES 12.0007x	E366100 replacing VAPT-E192514
Solenoid code	OA	OAM	OA/UL
Method of protection	Ex d		
Voltage code V _{DC} ±10%	12DC, 24DC, 28DC, 48DC, 110DC, 125DC, 220DC		12DC, 24DC, 110DC, 125DC, 220DC
Voltage code V _{AC} 50/60 Hz ±10%	12AC, 24AC, 110-120AC, 230-240AC (2)		
Power consumption	8W		12W
Coil insulation	Class H		
Protection degree	IP66/67 according to IEC 144		IP 67 According to IEC 144
Duty factor	100%		
Mechanical construction	Flame proof housing classified Ex d, according to EN 60079-0: 2006, EN 60079-1: 2007		Flame proof housing classified according to UL 1203 and UL429, CSA 22.2 n°30-1986 and CSA 22.2 n°139-13
Cable entrance and electrical wiring	Internal terminal board for cable connection threaded connection for cable entrance vertical (standard) or Horizontal (option /O)		

(1) The type examiner certificates can be downloaded from www.atos.com, catalog on line, technical information section

(2) For alternating current supply a rectifier bridge is provided built-in the solenoid

3.1 Multicertification

Multicertification for solenoids group II for surface plants with gas, vapours and dust environment

- **ATEX**
Ex II 2G Ex d IIC T6/T4 Gb
Ex II 2D Ex tb IIIC T85°C/T135°C Db
- **IECEX** worldwide recognized certification
Ex d IIC T6/T4 Gb
Ex tb IIIC T85°C/T135°C Db
- **EAC** EurAsian Certification
Ex II 2G Exd IIC T6/T4

Multicertification for solenoids group I for surface, tunnels or mining plants

- **ATEX**: Ex I M2 Ex db I Mb
- **IECEX**: Ex db I Mb

4 EX-PROOF SOLENOIDS: TEMPERATURE DATA

Certification	Multicertification for Group II		Multicertification for Group I	Certification cULus	
Temperature class	T6	T4	-	T6	T5
Surface temperature	≤ 85 °C	≤ 135 °C	150 °C	≤ 85 °C	≤ 100 °C
Ambient temperature (3)	-40 ÷ +45 °C	-40 ÷ +70 °C	-20 ÷ +70 °C	-40 ÷ +55 °C	-40 ÷ +70 °C

(3) The solenoids **Group II** and **cULus** are certified for minimum ambient temperature -40°C.

In case the complete valve must withstand with minimum ambient temperature of -40°C, select **/BT** in the model code



WARNING: service work provided on the valve by the end users or not qualified personnel invalidates the certification

4.1 UL certification

- Class I** = Equipment for famable gas and vapours
- Division 1** = Possibility of explosive atmosphere during normal functioning
- Groups C&D** = Atmosphere containing flammable gas
- Groups IIA&IIB** = Gas group
- T6/T5** = Temperature class of solenoid surface referred to +55°C / +70°C ambient temperature

5 INTRINSICALLY SAFE SOLENOIDS: MAIN DATA

Solenoid code	Group II ATEX	OW-18/6
	Group I ATEX (mining)	OWM-18/6
	Group II IECEX	OWI-18/6
	Group I IECEX (mining)	OWIM-18/6
Nominal resistance at 20°C	150	
Coil insulation	Class H	
Protection degree	IP65	
Duty factor	100%	
Electrical connector	DIN 43650 2 pin+GND	

5.1 Certification

Solenoids group II for surface plants with gas environment category 1, zone 0, 1 and 2

- ATEX 94/9/CE, Ex II 1 G, Ex ia IIC T6 (IIB T6 or IIA T5)
- IECEX, worldwide recognized safety certification Ex ia IIC T6 (IIB T6, IIA T5) Ga

Solenoids group I for surface, tunnels or mining plants

- ATEX 94/9/CE, Ex I M2 Ex ia I
- IECEX, worldwide recognized safety certification Ex ia (ib) I Mb

6 INTRINSICALLY SAFE SOLENOIDS: ELECTRICAL AND TEMPERATURE DATA

Method of protection	Ex ia / Ex ib according to EN60079-0: 2006, EN60079-11:2007						
Gas group	I and IIC			I and IIB		I and IIA	I
Temperature class	T6			T6		T5	-
Electrical characteristic	V max	27 V	19,5 V	19,11 V	28 V	28 V	12,4 V
	I max	130 mA	360 mA	360 mA	250 mA	396 mA	2200 mA
	P max	0,9 W	1,64 W	1,72 W	1,8 W	2,8 W	6,82 W
Minimum supply current	≥ 75mA, for I.S. barriers see section 12 to 13						
Surface temperature (ambient temp. 60°C)	≤ 85°C					≤ 100°C	
Ambient temperature	-40 ÷ +60°C (1)					-20 ÷ +60°C	

(1) The group II solenoids are ATEX certified for minimum temperature -40°C.
Select /BT in the valve code for the application with minimum temperature -40°C

7 CONFIGURATIONS and SPOOLS (representation according to ISO 1219-1)

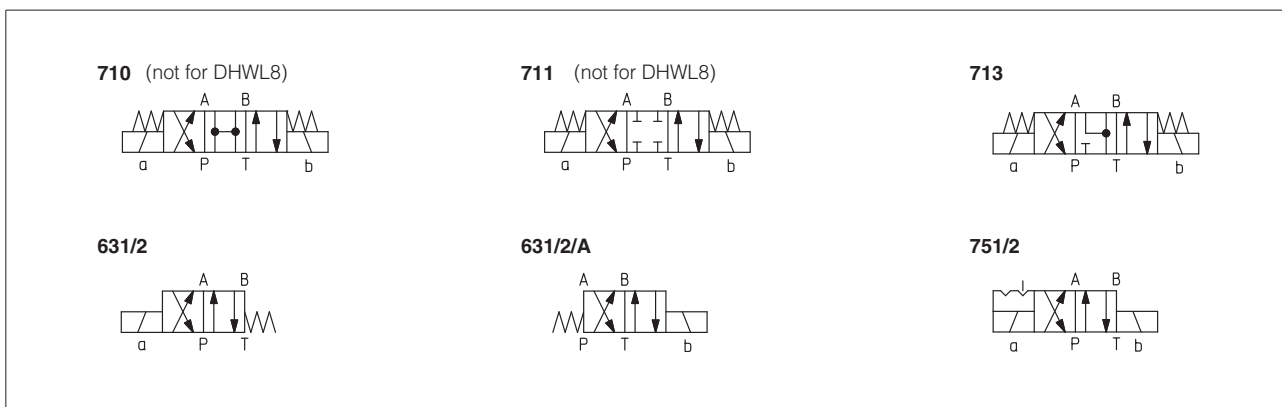

8 MAIN CHARACTERISTICS

Assembly position / location	DHAL8 any position, DHWL8 horizontal position only	
Subplate surface finishing	Roughness index Ra 0,4 - flatness ratio 0,01/100 (ISO 1101)	
Ambient temperature	Standard execution = -30°C ÷ +70°C /PE option = -20°C ÷ +70°C /BT option = -40°C ÷ +70°C	
Flow direction	As shown in the symbols of table 2	
Operating pressure	DHAL8	Ports P,A,B: 350 bar; Port T 210 bar
	DHWL8	Ports P,A,B: 250 bar; Port T 160 bar
Maximum flow	DHAL8	40 l/min see Q/Δp diagram at section 16 and operating limits at section 17
	DHWL8	20 l/min

9 SEALS AND HYDRAULIC FLUID - for other fluids not included in below table, consult our technical office

Seals, recommended fluid temperature	NBR seals (standard) = -20°C ÷ +60°C, with HFC hydraulic fluids = -20°C ÷ +50°C FKM seals (/PE option) = -20°C ÷ +80°C HNBR seals (/BT option) = -40°C ÷ +60°C, with HFC hydraulic fluids = -40°C ÷ +50°C		
Recommended viscosity	15 ÷ 100 mm ² /s - max allowed range 2.8 ÷ 500 mm ² /s		
Fluid contamination class	ISO 4406 class 21/19/16 NAS 1638 class 10, in line filters of 25 μm (β10 ≥75 recommended)		
Hydraulic fluid	Suitable seals type	Classification	Ref. Standard
Mineral oils	NBR, FKM, HNBR	HL, HLP, HLPD, HVLP, HVLPD	DIN 51524
Flame resistant without water	FKM	HFDU, HFDR	ISO 12922
Flame resistant with water	NBR, HNBR	HFC	

10 CABLE GLANDS AND WIRING - for DHAL8

10.1 Cable glands - only for Multicertification

Cable glands with threaded connections M20x1,5 for standard or armoured cables have to be ordered separately, see tech. table **K600**

10.2 Ex proof solenoid wiring

Multicertification

Standard version **Option /O**

- ① cover with threaded connection for vertical cable gland fitting
- ② cover with threaded connection for horizontal cable gland fitting
- ③ terminal board for cables wiring
- ④ screw terminal for additional equipotential grounding
- ⑤ standard manual override

○	1
○	2
○	3

1 = Coil PCB 3 poles terminal board
2 = GND suitable for wires cross sections
3 = Coil up to 2,5 mm² (max AWG14)

Power supply: section of coil connection wires = 2,5 mm²
Grounding: section of internal ground wire = 2,5 mm²
section of external ground wire = 4 mm²

Wiring specifications
Power supply: section of coil connection wires = 2,5 mm²
Grounding: section of internal ground wire = 2,5 mm²

The additional equipotential grounding can be also performed by the user on the external facility provided on the solenoid case.
Section of external ground wire = 4 mm²

cULus certification

Standard version **Option /O**

- ① cover with threaded connection for vertical cable gland fitting
- ② cover with threaded connection for horizontal cable gland fitting
- ③ terminal board for cables wiring
- ④ standard manual override

○	1
○	2
○	3

1 = Coil + PCB 3 poles terminal board
2 = GND suitable for wires cross sections
3 = Coil - up to 2,5 mm² (max AWG14)

(2) = alternative GND screw terminal connected to solenoid housing

Cable Specification:
Power supply and transducer cables have to comply with following characteristics

- Suitable for use in Class I Division 1, Gas Groups C
- Armored Marine Shipboard Cable which meets UL 1309
- Tinned Stranded Copper Conductors
- Bronze braided armor
- Overall impervious sheath over the armor

Any Listed (UBVZ/ UBVZ7) Marine Shipboard Cable rated 300 V min, 15A min. 3C 2,5 mm² (14 AWG) having a suitable service temperature range of at least -25°C to +110°C ("BT" Models require a temperature range from -40°C to +110°C)

For Class I wiring the 3C 1,5 mm² AWG 16 cable size is admitted only if a fuse lower than 10 A is connected to the load side of the solenoid wiring.

Note: a Loctite sealant type 545, should be used on the cable gland entry threads

10.3 Cable temperature

The cable must be suitable for the working temperature as specified in the "safety instructions" delivered with the first supply of the products.

For Multicertification

Max ambient temperature [°C]	Temperature class	Surface temperature [°C]	Cable temperature
45 °C	T6	<85 °C	not prescribed
70 °C	T4	<135 °C	90 °C

For cULus

Max ambient temperature [°C]	Temperature class	Surface temperature [°C]	Cable temperature
55 °C	T6	<85 °C	100 °C
70 °C	T5	<100 °C	100 °C

11 WIRING - for DHWL8

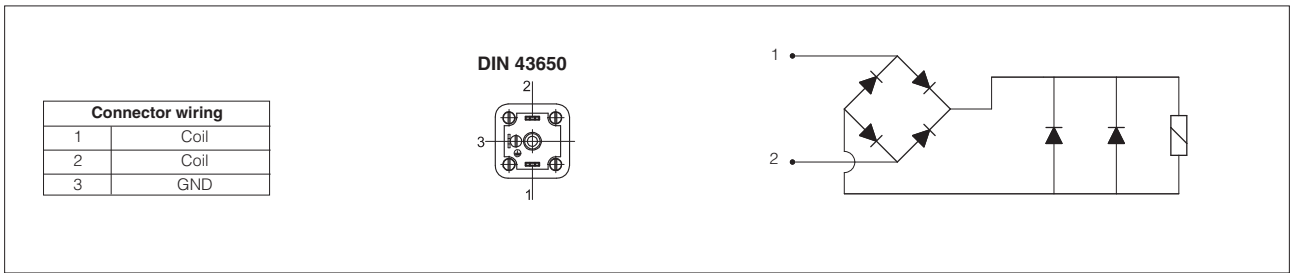

12 INTRINSICALLY SAFE BARRIERS - for DHWL8

The electric supply to these solenoids must be done through electronic devices situated out of potentially flammable environment (i.e. in safe zone), which limit the electric current to the intrinsically safe solenoid. These electronic devices are normally called "intrinsically safe barriers" approved and certified according to the Ex ia protection mode. To select the proper intrinsically safe barriers following data must be considered:

- 1) V_{max} and I_{max} of the solenoid as specified in section 6 must not be exceeded also in fault conditions;
- 2) the resistance of the solenoid is 150Ω and the current supplied by the barrier, in normal operation condition, must be over 75 mA to ensure the valve correct operation.

The barriers type Y-BXNE 412 are galvanically isolated electronic devices, developed according to the European Norms EN60079-0/06, EN60079-11/07 and certified ATEX 94/9/CE, protection mode Ex ia IIC.

These barriers ensure the optimized functioning of the Atos valves up to the max operating limits specified in section 17.

The barriers Y-BXNE-412 are double channel type, suitable to operate valves with double or single solenoid.

Two single solenoid valves can be connected to the barrier (one to each channel) but they cannot be contemporary operated.

13 MODEL CODE OF I.S. BARRIER

**13.1 I.S. barrier for double solenoid valves
Y-BXNE 412 00 ***

Supply voltage
E = 110/230 V_{AC}
2 = 24÷48 V_{DC}

The above barrier can be used both for double or for single solenoid valves
 With one barrier, two single solenoid valves can be operated but not contemporary

14 TECHNICAL CHARACTERISTICS OF I.S. BARRIER

	Y-BXNE 412
N° output channels	2
Power supply voltage	110÷230 V _{AC} ±10% (50/60 Hz) 21,6 ÷ 53 V _{DC}
Power consumption	< 3W
Output voltage U _o	19,5 V
Output current I _o	341 mA
Output power P _o	1,64 W
Galvanic insulation supply/output	2500 V _{AC} / 50 Hz
Storage temperature	-25 °C ÷ +70 °C
Working temperature	-10 °C ÷ +60 °C
Housing material	ABS case
Mounting	on rail EN 50022
Electrical connections	screw terminals
Method of protection	Ex ia IIC
ATEX classification	Ex II 1 G/D

15 INSTALLATION DIMENSIONS OF I.S. BARRIER [mm]

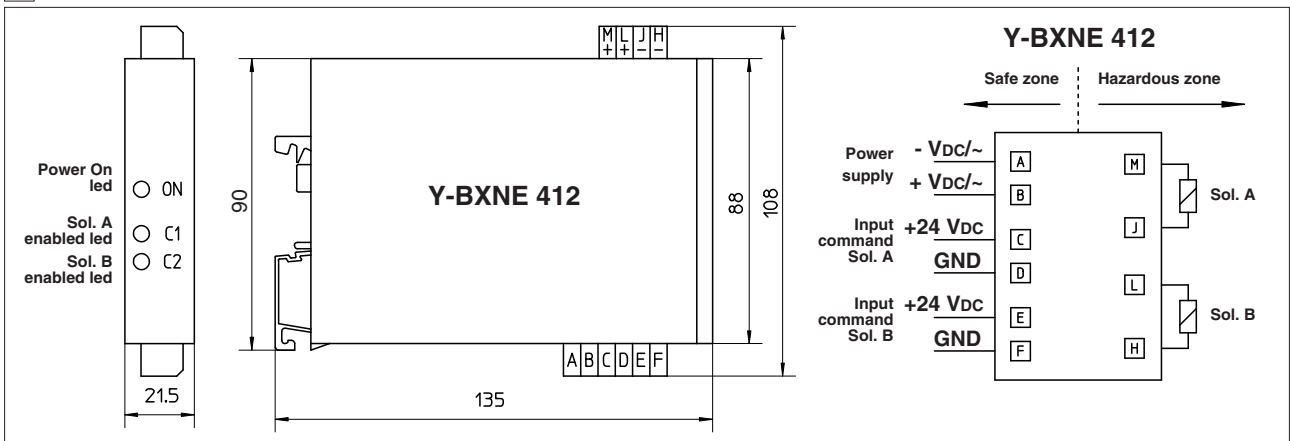

16 Q/ΔP DIAGRAMS based on mineral oil ISO VG 46 at 50°C

DHAL8

Flow direction Spool type	Flow direction					
	P→A	P→B	A→T	B→T	P→T center	A→T B→T center
0	A	A	A	A	E	
1	C	C	B	B		
1/2	C	B	C	B		
3	C	C	A	A		E

DHWL8

Flow direction Spool type	Flow direction					
	P→A	P→B	A→T	B→T	P→T center	A→T B→T center
0	A	A	A	A	E	
1	C	C	B	B		
1/2	B	A	C	D		
3	C	C	A	A		E

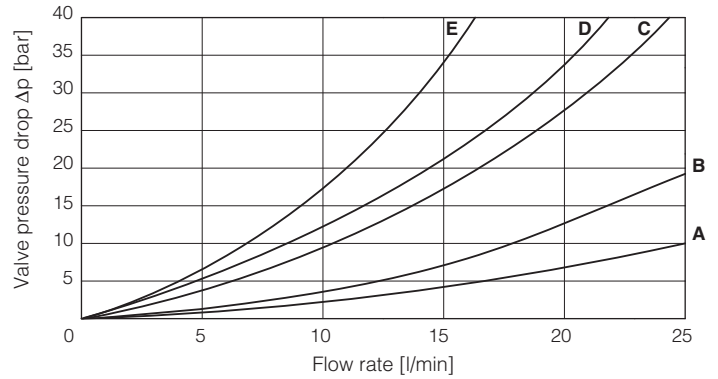
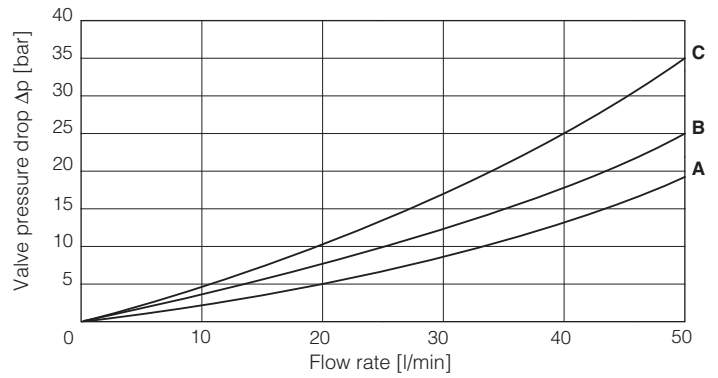

17 OPERATING LIMITS based on mineral oil ISO VG 46 at 50°C

The diagrams have been obtained with warm solenoids and power supply at lowest value ($V_{nom} - 10\%$). The curves refer to application with symmetrical flow through the valve (i.e. P→A and B→T). In case of asymmetric flow and if the valves have the devices for controlling the switching times the operating limits must be reduced.

DHAL8

Curve	spool type
A	all spools

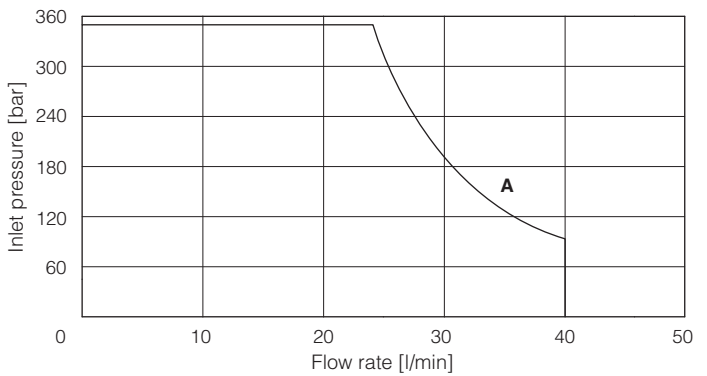

DHWL8

Curve	spool type/current supply
A	all spools / 80 mA
B	all spools / 75 mA

note: valve P/Q limits depends to the current supply provided from the intrinsically safe barrier. In the diagrams are reported the P/Q limits at current 75 mA and 80 mA

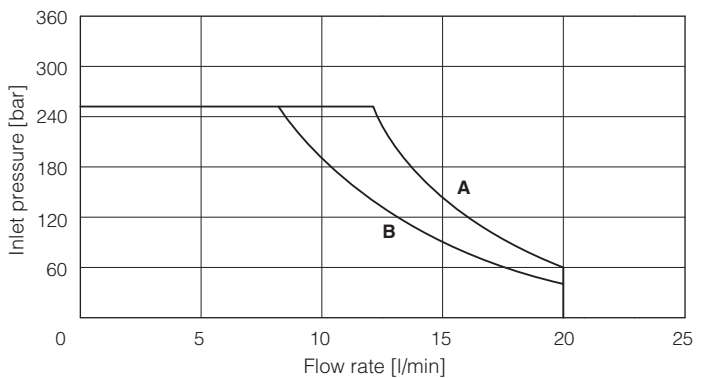

18 INTERNAL LEAKAGES based on mineral oil at viscosity 15 cSt

Spool type	center pos.	Flow direction	
		P→A B→T	P→B A→T
0		C	C
1	C	B	B
1/2		A	A
3	C	B	B

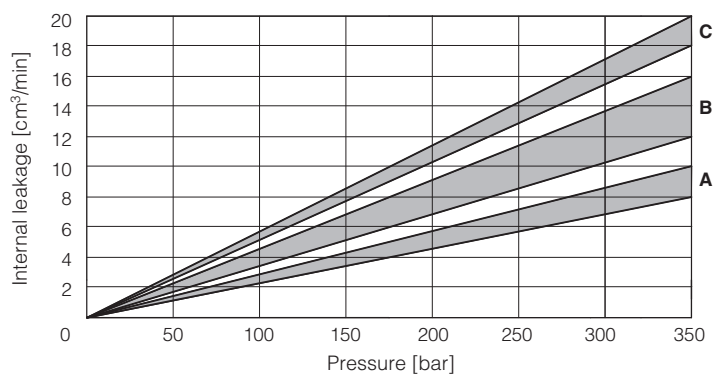
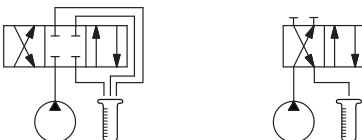

19 DIMENSIONS - for DHAL8 multicertified and UL [mm]

ISO 4401: 2005

Mounting surface: 4401-03-02-0-05

Fastening bolts: 4 socket head screws:

M5x50 class 12.9

Tightening torque = 8 Nm

Seals: 4 OR 108

Ports P,A,B,T: $\varnothing = 7.5$ mm (max)

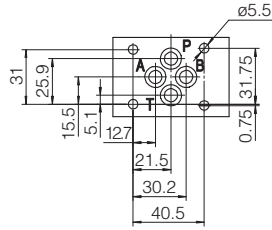

P = PRESSURE PORT
A, B = USE PORT
T = TANK PORT

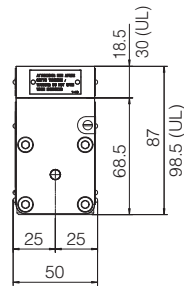
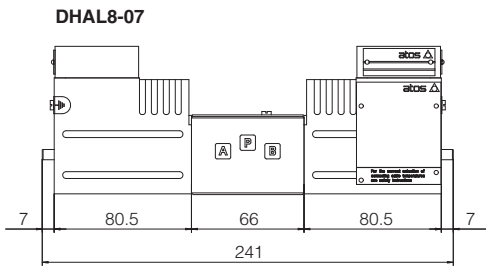
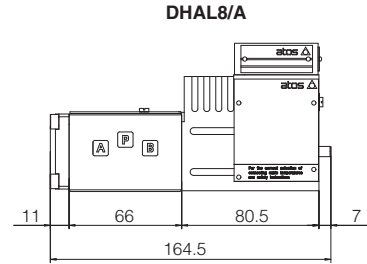
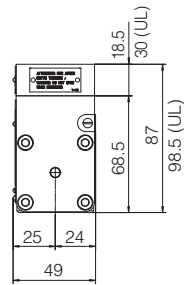
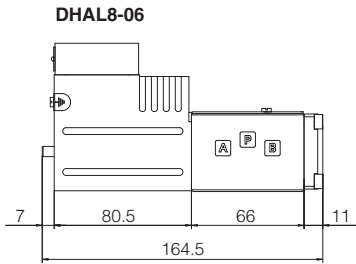

Mass (Kg)	
DHA-06	2,65
DHA-07	4,3
Option /O	+0,35
Option /WP	+0,25

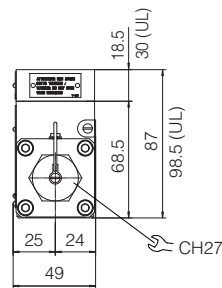
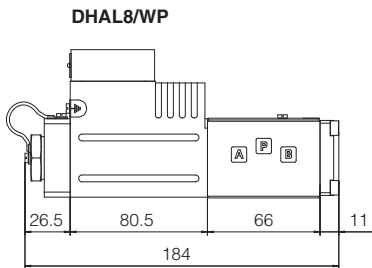
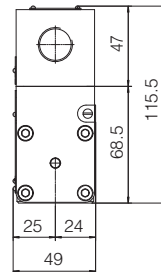
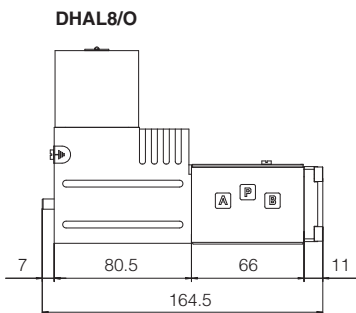

20 DIMENSIONS for DHWL8 [mm]

ISO 4401: 2005

Mounting surface: 4401-03-02-0-05 (see table P005)

Fastening bolts: 4 socket head screws M5x50 class 12.9

Tightening torque = 8 Nm

Seals: 4 OR 108;

Diameter of ports A, B, P, T: \varnothing 7,5 mm (max)

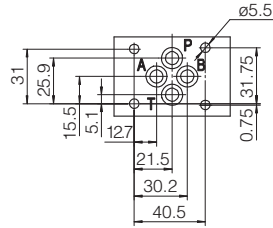

P = PRESSURE PORT
A, B = USE PORT
T = TANK PORT

Mass (Kg)	
DHWL8-06	3
DHWL8-07	5

DHWL8-06

Standard version

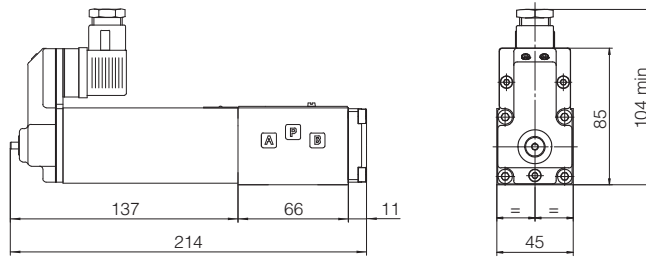
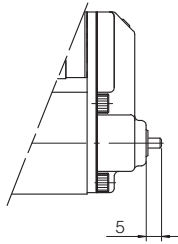

Mining version

(different cover shape for mining version)

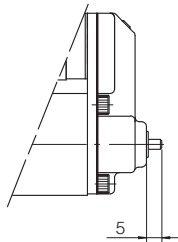

DHWL8-06/A

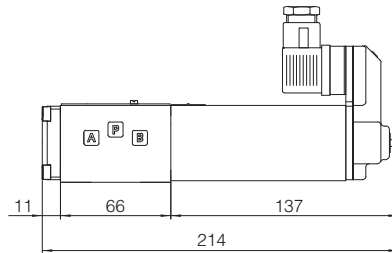

Option /WP

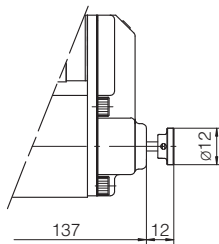

DHWL8-07

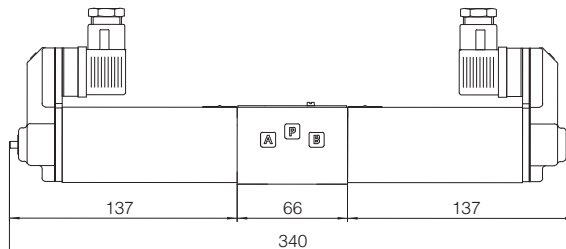

Note: the connector is supplied with the valves