

Intrinsically safe pressure relief valves

piloted, subplate or in line mounting - **ATEX** or **IECEX** certification

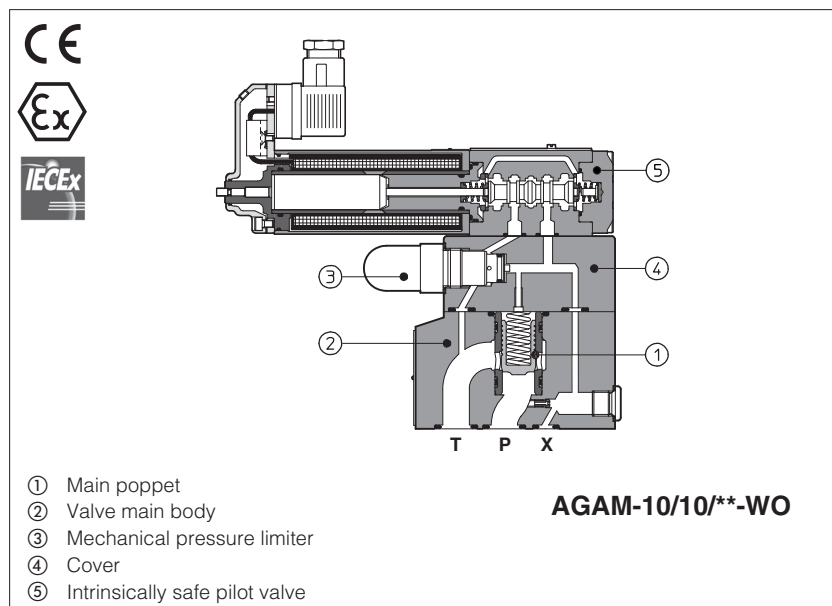

AGAM, ARAM

Intrinsically safe pressure relief valves equipped with solenoid pilot valve for venting or multiple pressure selection, certified for safe operation in hazardous environment with potentially explosive atmosphere.

Certifications:

- **ATEX** or **IECEX**:
II 1G Ex ia IIC, IIB, IIA
surface plants zone 0, 1 and 2

- **ATEX** or **IECEX**:
IM2 Ex ia IMb, Ex ib IMb
surface, tunnels or mining plants

The valves must be electrically powered through specific "safety barriers" limiting the max current to the solenoid, see section **10**.

AGAM: pressure relief, subplate mounting
Size: **10, 20** and **32** - ISO 6264
Max flow: **200, 400** and **600 l/min**

ARAM: pressure relief, threaded connections
Size: **20** and **32** - G 3/4" and G 1 1/4"
Max flow: **350** and **500 l/min**

Max pressure: **350 bar**

1 MODEL CODE

AGAM	/	*	-	20	/	20	/	210/100/100	-	WO	/	*	/	6	/	**	/	*						
<p>Intrinsically safe pressure relief valves, piloted</p> <p>AGAM subplate mounting</p> <p>ARAM threaded connections</p> <p>Certification type: - = Omit for Atex Group II M = Atex Group I (mining) IE = IECEX Group II IEM = IECEX Group I (mining)</p> <p>Valve size: 10 = AGAM (ISO 6264) 20 = AGAM (ISO 6264) 32 = AGAM (ISO 6264) 20 = ARAM G 3/4" 32 = ARAM G 1 1/4"</p> <p>Configuration, see section 2 :</p> <table style="display: inline-table; border: none;"> <tr> <td>10</td> <td>20</td> <td>22</td> </tr> <tr> <td>11</td> <td>21</td> <td>32</td> </tr> </table>																			10	20	22	11	21	32
10	20	22																						
11	21	32																						
<p style="text-align: right;">Seals material, see section 6 :</p> <p style="text-align: right;">- = NBR PE = FKM BT = HNBR (1)</p> <p style="text-align: right;">Series number</p> <p style="text-align: right;">Connector type: 6 = DIN 43650 (standard)</p> <p>Options (2): E = external pilot V = regulating handweel for pressure adjustment WP = manual override Y = external drain</p> <p>WO = intrinsically safe solenoid</p> <p>Max regulated pressure of first (second / third) setting, see section 4 :</p> <table style="display: inline-table; border: none;"> <tr> <td>50 = 50 bar</td> <td>100 = 100 bar</td> </tr> <tr> <td>210 = 210 bar</td> <td>350 = 350 bar</td> </tr> </table>																			50 = 50 bar	100 = 100 bar	210 = 210 bar	350 = 350 bar		
50 = 50 bar	100 = 100 bar																							
210 = 210 bar	350 = 350 bar																							

(1) Not for certification **M** and **IEM**, Group I (mining)

(2) Possible combined options: all combinations are available

The pressure at T port makes difficult the manual override operation that can be possible only if its value is lower than 50 bar

2 CONFIGURATIONS AND HYDRAULIC SYMBOLS

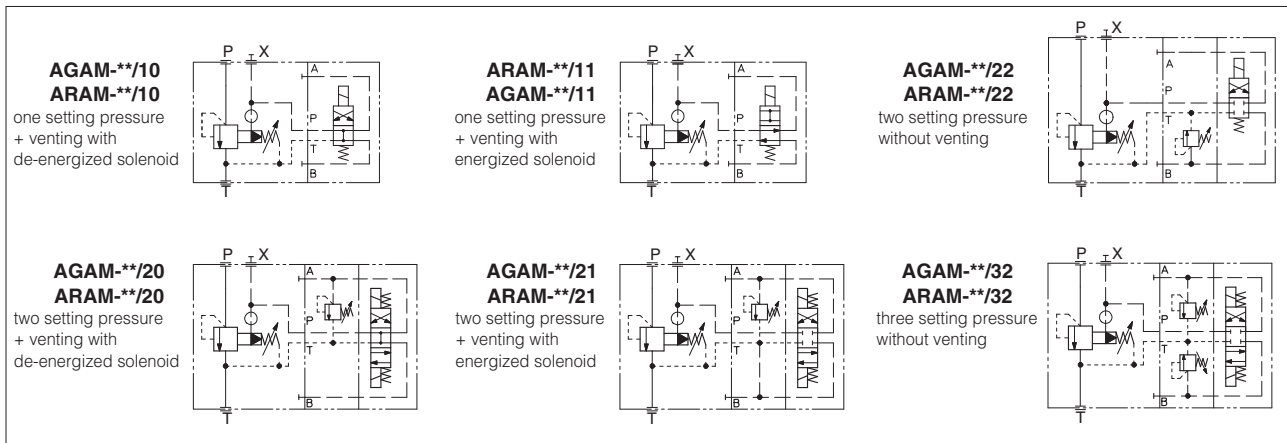

3 GENERAL CHARACTERISTICS

Assembly position / location	Horizontal position only
Subplate surface finishing to ISO 4401	Acceptable roughness index, $R_a \leq 0,8$ recommended $R_a 0,4$ - flatness ratio 0,01/100
MTTFd values according to EN ISO 13849	75 years, for further details see technical table P007
Ambient temperature	Standard = $-20^\circ\text{C} \div +60^\circ\text{C}$ / IPE option = $-20^\circ\text{C} \div +60^\circ\text{C}$ / BT option = $-40^\circ\text{C} \div +60^\circ\text{C}$
Storage temperature range	Standard = $-20^\circ\text{C} \div +70^\circ\text{C}$ / IPE option = $-20^\circ\text{C} \div +70^\circ\text{C}$ / BT option = $-40^\circ\text{C} \div +70^\circ\text{C}$
Surface protection	Zinc coating with black passivation - salt spray test (EN ISO 9227) > 200h
Compliance	Intrinsically safe protection "Ex ia", see section 7 RoHS Directive 2011/65/EU as last update by 2015/65/EU REACH Regulation (EC) n°1907/2006

4 HYDRAULIC CHARACTERISTICS

Valve size	10	20	32
Max operating pressure [bar]	port P = 350 port T, Y = 210		
Max regulated pressure [bar]	50	100	210 350
Pressure range [bar]	4÷50;	6÷100;	7÷210; 8÷350
Max flow AGAM (1) [l/min]	200	400	600
Max flow ARAM (1) [l/min]	-	350	500

(1) see Q/Δp diagrams at section [11](#) and [12](#)

5 ELECTRICAL CHARACTERISTICS - see also section [7](#)

Nominal resistance at 20°C	150 Ω
Coil insulation	Class H
Working voltage	12 ÷ 26 V
Minimum supply current	65mA, from I.S. barriers
Protection degree	IP66
Duty factor	100%
Electrical connector	DIN 43650 2 pin+GND

6 SEALS AND HYDRAULIC FLUIDS - for other fluids not included in below table, consult our technical office

Seals, recommended fluid temperature	NBR seals (standard) = -20°C ÷ +60°C, with HFC hydraulic fluids = -20°C ÷ +50°C FKM seals (/PE option) = -20°C ÷ +80°C HNBR seals (/BT option) = -40°C ÷ +60°C, with HFC hydraulic fluids = -40°C ÷ +50°C		
Recommended viscosity	15 ÷ 100 mm ² /s - max allowed range 2.8 ÷ 500 mm ² /s		
Max fluid contamination level	ISO 4406 class 20/18/15 NAS 1638 class 9, see also filter section at www.atos.com or KTF catalog		
Hydraulic fluid	Suitable seals type	Classification	Ref. Standard
Mineral oils	NBR, FKM, HNBR	HL, HLP, HLPD, HVLP, HVLPD	DIN 51524
Flame resistant without water	FKM	HFDU, HFDR	ISO 12922
Flame resistant with water	NBR, HNBR	HFC	

 The ignition temperature of the hydraulic fluid must be 50°C higher than the max solenoid surface temperature

(1) Performance limitations in case of flame resistant fluids with water:

- max operating pressure = 210 bar
- max fluid temperature = 50°C

7 CERTIFICATION DATA

Valve type	AGAM ARAM		AGAM/IE ARAM/IE		AGAM/M ARAM/M		AGAM/IEM ARAM/IEM					
Certification	ATEX (Group II)		IECEX (Group II)		ATEX (mining) (Group I)		IECEX (mining) (Group I)					
Solenoid code	OW-18/6		OWI-18/6		OWM-18/6		OWIM-18/6					
Type examination certificate (1)	CESI 02 ATEX 013		IECEX CES 12.0017		CESI 02 ATEX 013		IECEX CES 12.0017					
Method of protection	Ex II 1G Ex ia					Ex I M2 Ex ia I Mb Ex ib I Mb						
	IIA T5 Ga	IIB T6 Ga	IIC T6 Ga									
Electrical characteristics (max values)	Ui [V]	28	28	27	19,5	19,11	28	28	27	19,5	19,11	12,4
	Ii [mA]	396	250	130	360	360	396	250	130	360	360	2200
	Pi [W]	2,8	1,8	0,9	1,64	1,72	2,8	1,8	0,9	1,64	1,72	6,82
	Ci , Li	≅ 0	≅ 0			≅ 0						
Temperature class	T5		T6			-						
Surface temperature (ambient temp. +60°C)	≤ 100°C		≤ 85°C			≤ 150°C						
Ambient temperature	-20 ÷ +60°C		-40 ÷ +60°C (2)			-20 ÷ +60°C						
Applicable standards	EN 60079-0 EN 60079-11 EN 60079-26				IEC 60079-0 IEC 60079-11 IEC 60079-26							

(1) The type examiner certificates can be downloaded from www.atos.com

(2) Only for /BT option

 **WARNING: service work performed on the valve by the end users or not qualified personnel invalidates the certification**

8 OPTIONS

E = External pilot option to be selected when the pilot pressure is supplied from a different line respect to the P main line.
With option E the internal connection between port P and X of the valve is plugged.
The pilot pressure must be connected to the X port available on the valve's mounting surface or on main body (threaded pipe connection G 1/4").

V = Regulating handweel for pressure adjustment

WP = Manual override protect by metallic cap

Y = The external drain is mandatory in case the main line T is subjected to pressure peaks or it is pressurized.
The Y drain port has a threaded connection G 1/4" available on the pilot stage body.

11.1 Possible combined options: all combinations are available

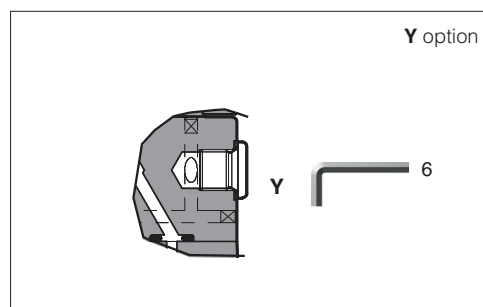
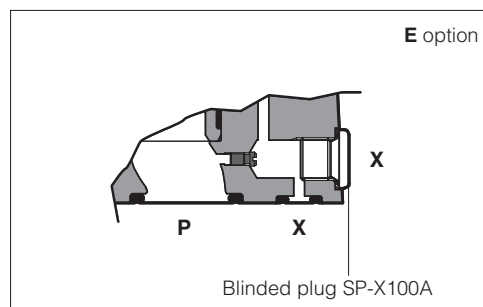

9 SOLENOIDS WIRING

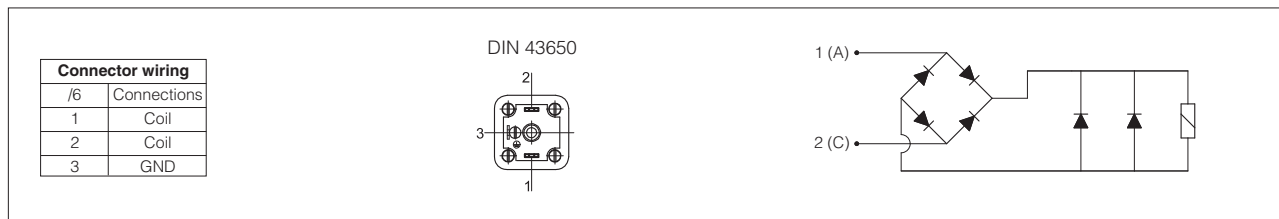

10 INTRINSICALLY SAFE BARRIERS - see tech. table **GX010**

Intrinsically safe valves must be powered through safety barriers certified according to Ex-ie protection mode, limiting the energy to the solenoid.

To select the proper intrinsically safe barriers following data must be considered:

- 1) V_{max} and I_{max} of the solenoid as specified in section 7 must not be exceeded also in fault conditions;
- 2) the resistance of the solenoid is 150Ω and the current supplied by the barrier, in normal operation condition, must be over the min. limit (65 mA) to ensure the valve correct operation (over 70 mA for max performances).

The barriers type **Y-BXNE 412** are galvanically isolated electronic devices, complying with European Norms EN60079-0/06, EN60079-11/07 and ATEX certified according to protection mode Ex ia IIC.

These barriers ensure the optimized functioning of the Atos valves up to the max operating limits specified in section 4.

The barriers Y-BXNE-412 are double channel type, suitable to operate valves with double or single solenoid. Two single solenoid valves can be connected to the barrier (one to each channel) but they cannot be contemporary operated.

MODEL CODE OF I.S. BARRIER

Y-BXNE 412 00

*

Supply voltage
E = 110/230 VAC
2 = 24÷48 VDC

11 REGULATED PRESSURE VERSUS FLOW DIAGRAMS based on mineral oil ISO VG 46 at 50°C

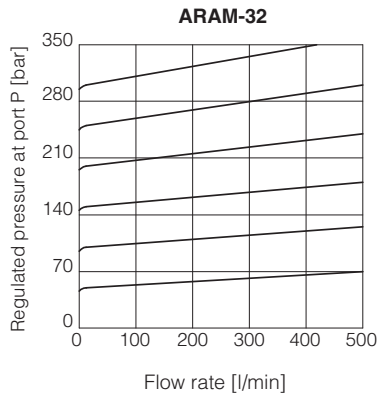
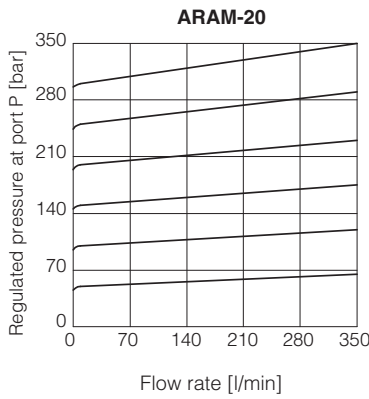
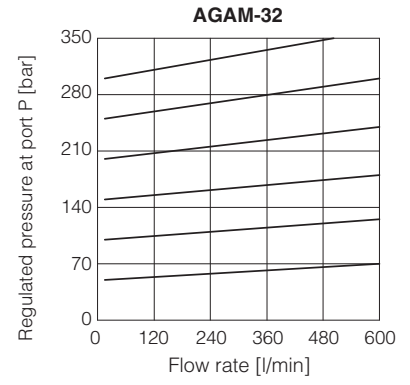
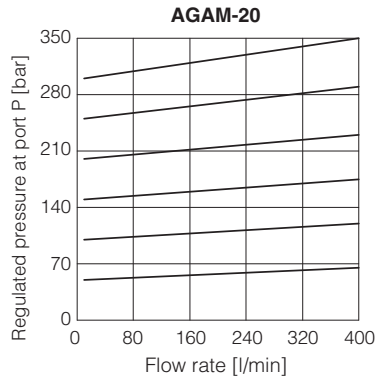
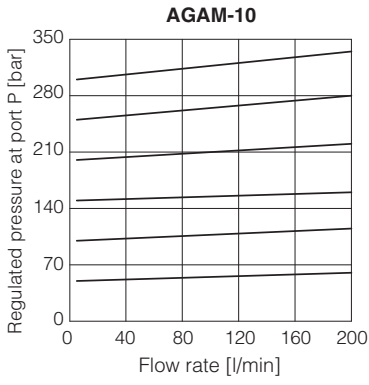

12 MINIMUM PRESSURE VERSUS FLOW DIAGRAMS based on mineral oil ISO VG 46 at 50°C

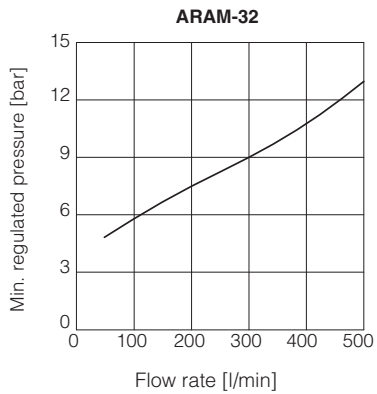
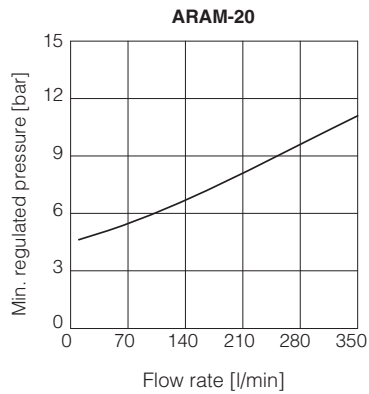
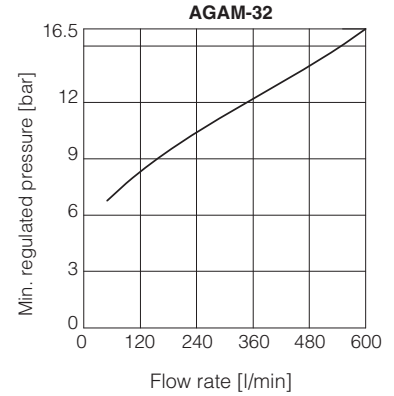
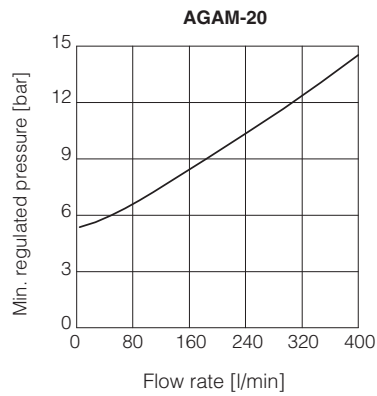
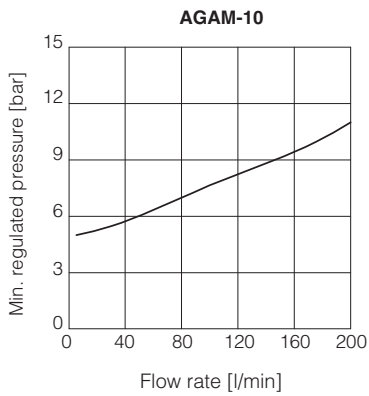

AGAM-10

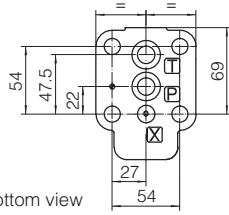

ISO 6264: 2007 (see table P005)
Mounting surface: 6264-06-09-1-97
 Fastening bolts:
 4 socket head screws M12x35 class 12.9
 Tightening torque = 125 Nm
 Seals: 2 OR 123; 1 OR 109/70
 Ports P, T: $\varnothing = 14,5$ mm
 Ports X: $\varnothing = 3,2$ mm

Mass [kg]	
AGAM-10/10 10/11	6,45
AGAM-10/20 10/21	7,55
AGAM-10/22 10/32	7,25 9

X = port connection for external pilot (option /E)
Y = port connection for external drain (option /Y)

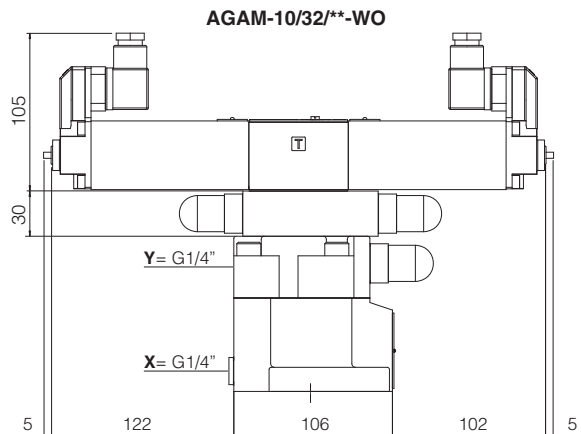
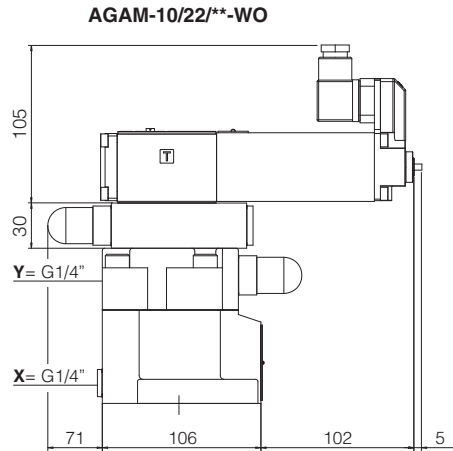
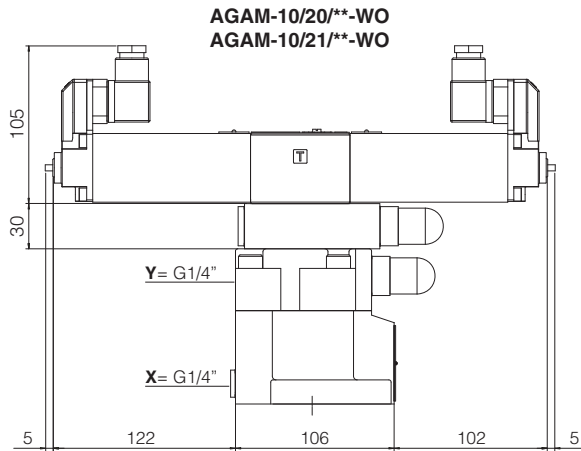
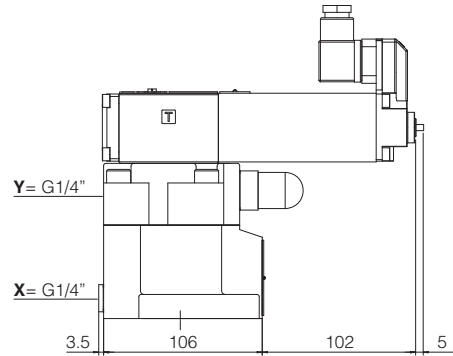
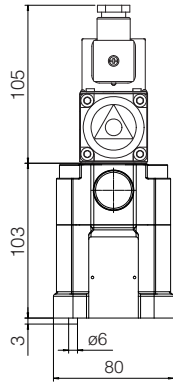

Option /WP

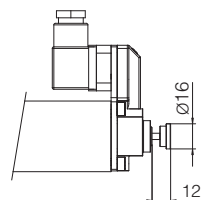

Mining version /M and /IEM
(different cover shape)

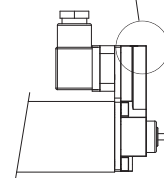

Option /V

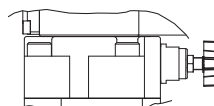

AGAM-20

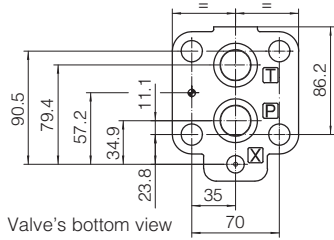

ISO 6264: 2007 (see table P005)
Mounting surface: 6264-08-11-1-97
 Fastening bolts:
 4 socket head screws M16x50 class 12.9
 Tightening torque = 300 Nm
 Seals: 2 OR 4112; 1 OR 109/70
 Ports P, T: $\varnothing = 24$ mm
 Ports X: $\varnothing = 3,2$ mm

Mass [kg]	
AGAM-20/10 20/11	7,65
AGAM-20/20 20/21	8,75
AGAM-20/22 20/32	8,45 10,2

X = port connection for external pilot (option /E)
Y = port connection for external drain (option /Y)

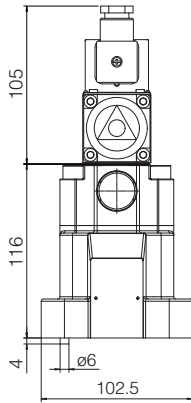

AGAM-20/10/-WO**
AGAM-20/11/-WO**

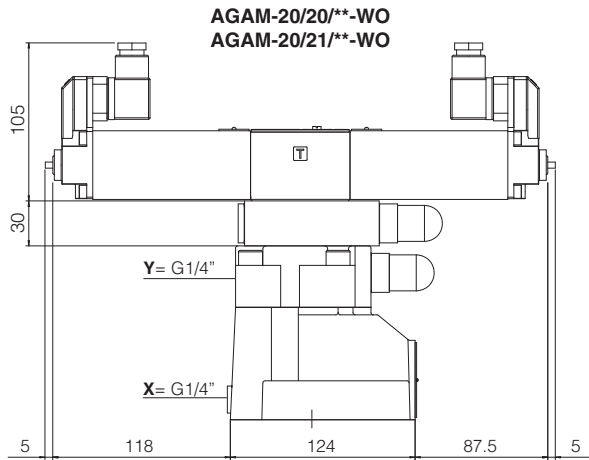
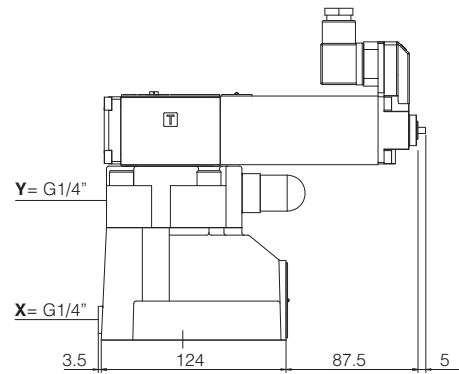

AGAM-20/20/-WO**
AGAM-20/21/-WO**

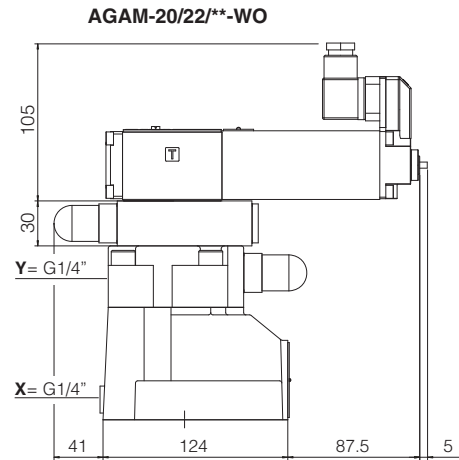

AGAM-20/22/-WO**

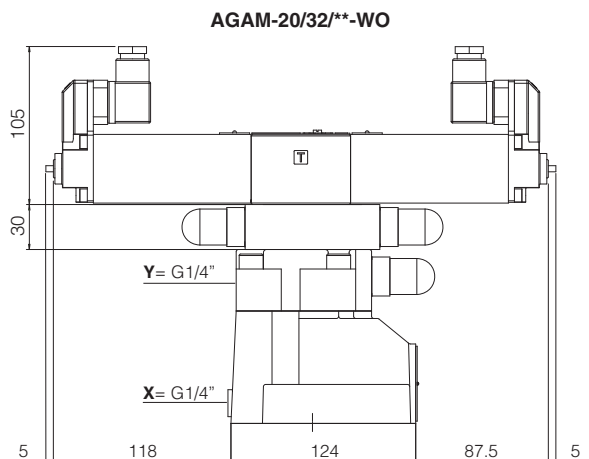

AGAM-20/32/-WO**

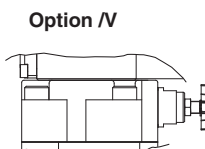
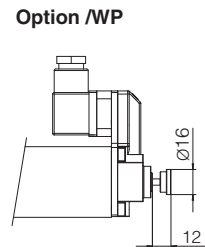

Mining version /M and /IEM
 (different cover shape)

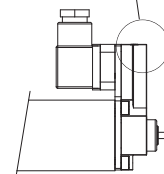

AGAM-32

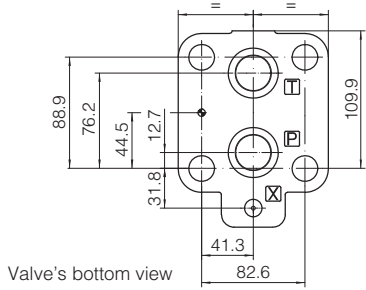

ISO 6264: 2007 (see table P005)
Mounting surface: 6264-10-17-1-97
(with M20 fixing holes instead of standard M18)
 Fastening bolts:
 4 socket head screws M20x60 class 12.9
 Tightening torque = 600 Nm
 Seals: 2 OR 4131; 1 OR 109/70
 Ports P, T: $\varnothing = 28,5$ mm
 Ports X: $\varnothing = 3,2$ mm

Mass [kg]	
AGAM-32/10 32/11	9,05
AGAM-32/20 32/21	10,05
AGAM-32/22 32/32	9,85 11,6

X = port connection for external pilot (option /E)
Y = port connection for external drain (option /Y)

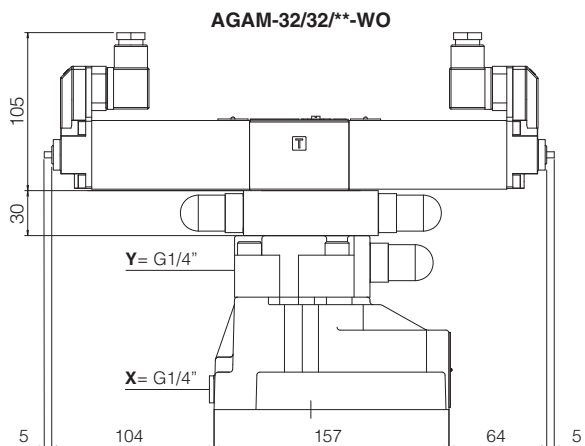
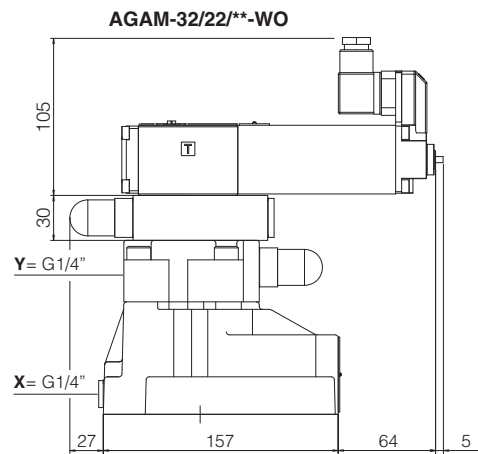
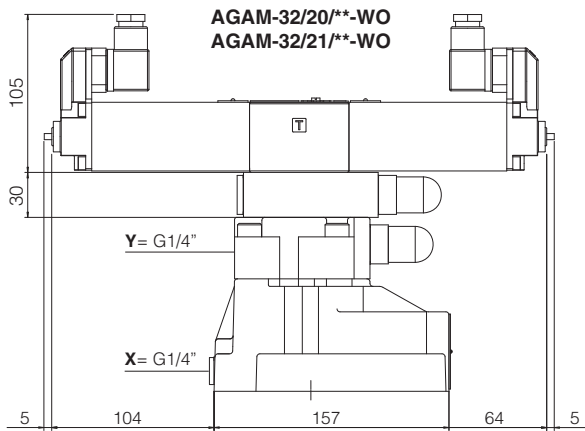
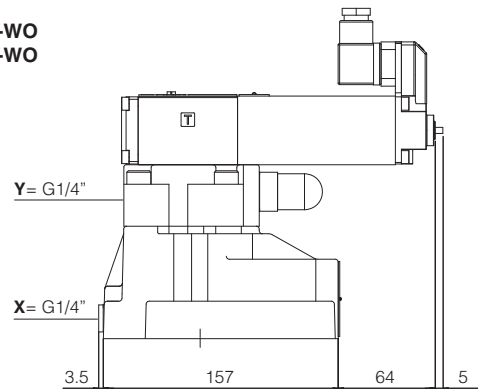
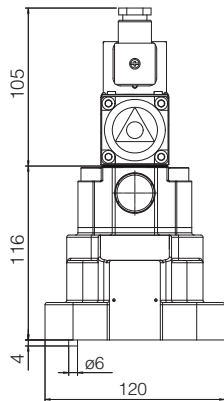

Option /WP

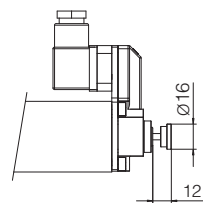

Mining version /M and /IEM
 (different cover shape)

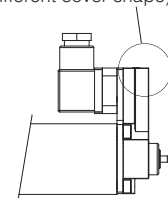

Option /V

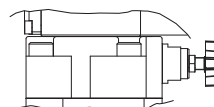

ARAM-20

X = port connection for external pilot (option /E)
 Y = port connection for external drain (option /Y)

Mass [kg]	
ARAM-20/10 20/11	6,75
ARAM-20/20 20/21	8,45
ARAM-20/22 20/32	8,15 10,1

ARAM-20/10-WO
 ARAM-20/11**-WO**

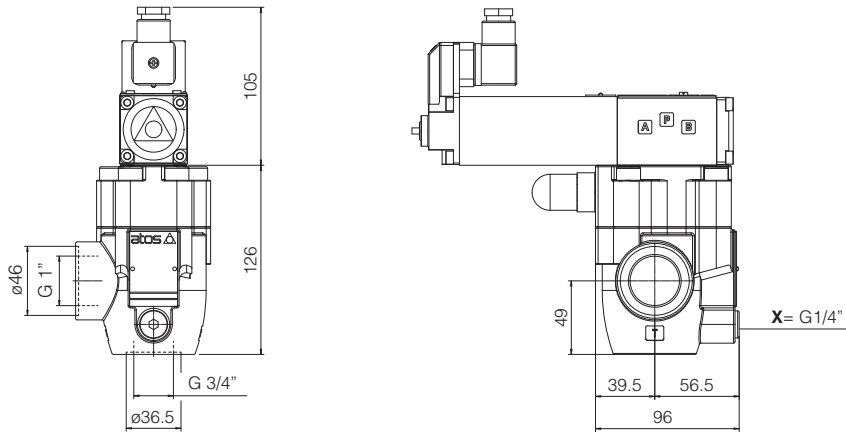

ARAM-20/20-WO
 ARAM-20/21**-WO**

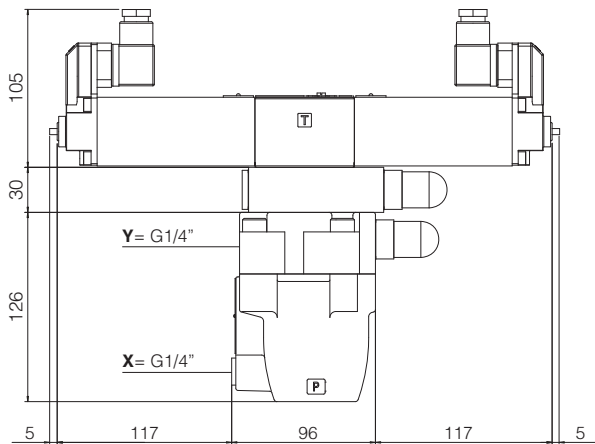

ARAM-20/22-WO**

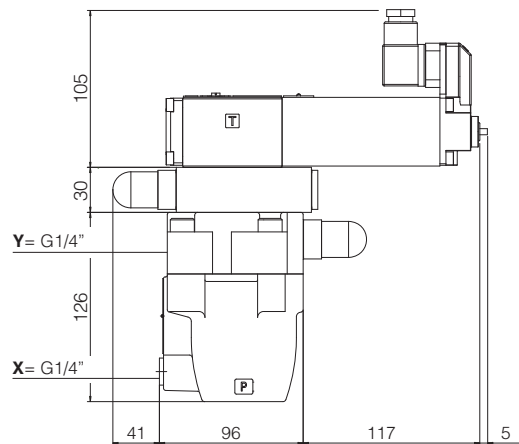

ARAM-20/32-WO**

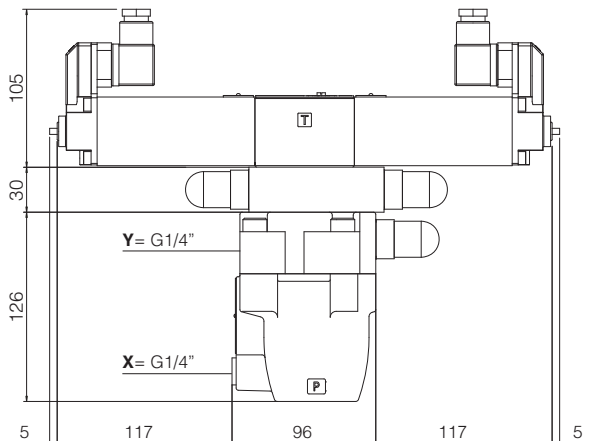

Option /WP

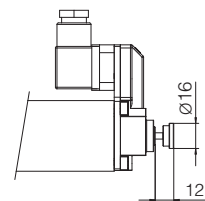

**Mining version /M and /EM
 (different cover shape)**

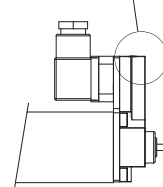

Option /V

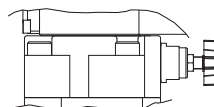

ARAM-32

X = port connection for external pilot (option /E)
Y = port connection for external drain (option /Y)

Mass [kg]	
ARAM-32/10 32/11	7,05
ARAM-32/20 32/21	9,05
ARAM-32/22 32/32	8,55
	10,7

ARAM-32/10/-WO**
ARAM-32/11/-WO**

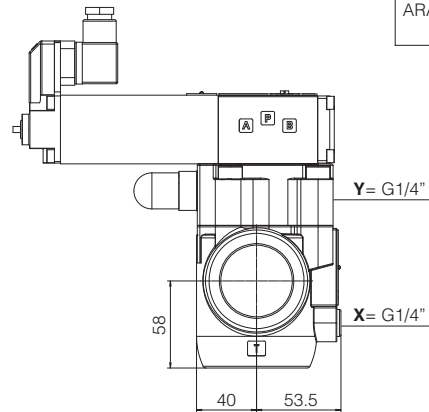
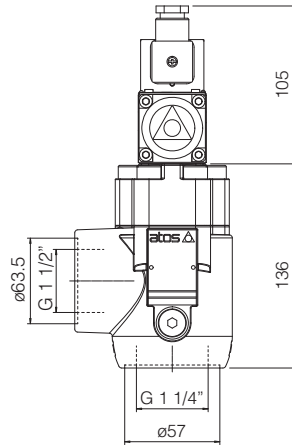

ARAM-32/20/-WO**
ARAM-32/21/-WO**

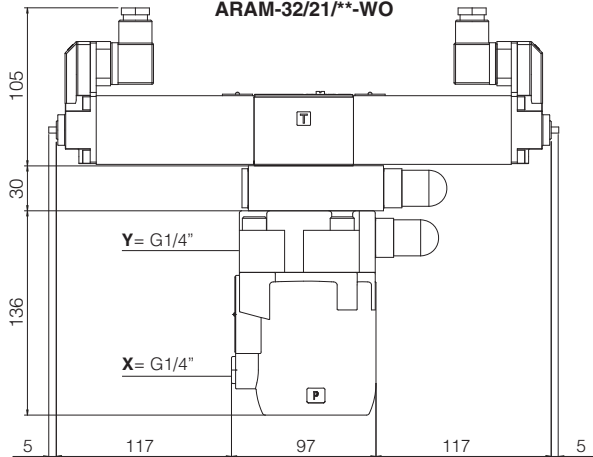

ARAM-32/22/-WO**

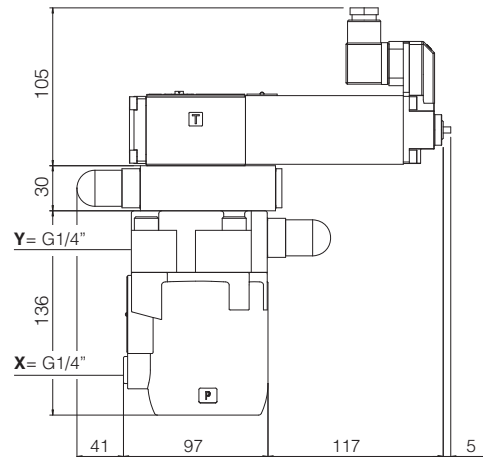

ARAM-32/32/-WO**

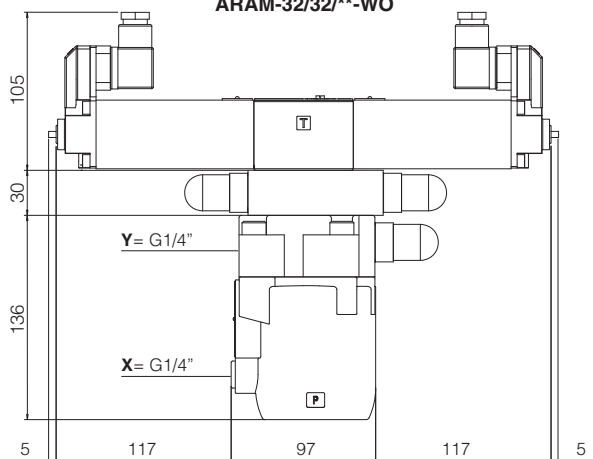

Option /WP

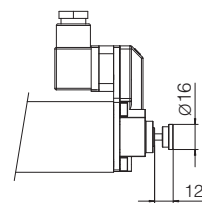

Mining version /M and /EM
 (different cover shape)

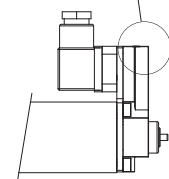

Option /V

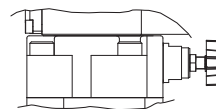

15 RELATED DOCUMENTATION

- X010** Basics for electrohydraulics in hazardous environments
- X050** Summary of Atos intrinsically safe components certified to ATEX, IECEx
- EX950** Operating and maintenance information for intrinsically safe valves
- P005** Mounting surfaces for electrohydraulic valves