

# Ex-proof proportional reducing valves

direct or piloted, without transducer - **ATEX, IECEx, EAC, PESO** or **cULus**

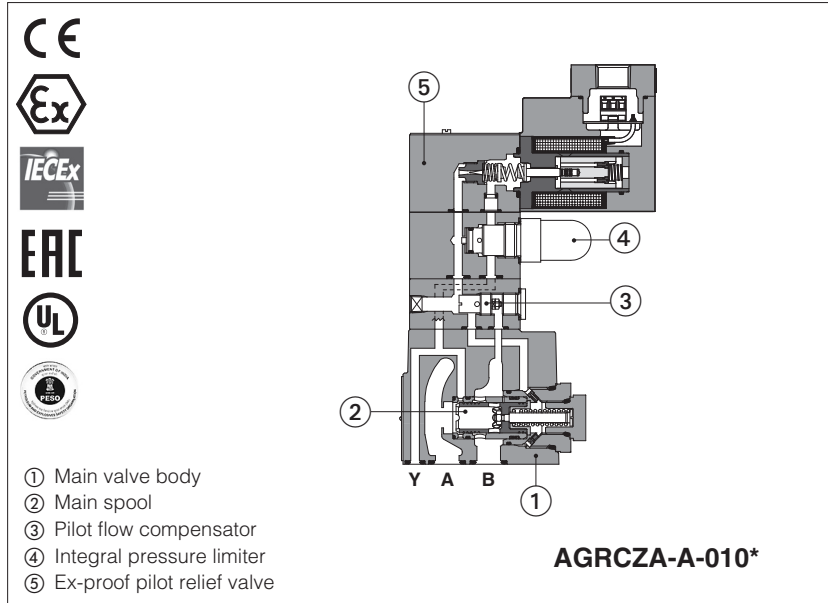

## RZGA-A, HZGA-A KZGA-A, AGRCZA-A

Ex-proof proportional reducing valves direct or piloted, for open loop pressure controls. They are equipped with ex-proof proportional solenoid, certified for safe operations in hazardous environments with potentially explosive atmosphere.

Certifications:

- Multicertification **ATEX, IECEx, EAC** and **PESO** for gas group **II 2G** and dust category **II 2D**
- Multicertification **ATEX** and **IECEx** for gas group **I M2** (mining)
- **cULus** North American certification for gas group **C&D**

**RZGA, HZGA**, direct or piloted:

Size: **06** - ISO 4401  
 Max flow: **12** and **40** l/min

**KZGA**, piloted:  
 Size: **10** - ISO 4401  
 Max flow: **100** l/min

**AGRCZA**, piloted:  
 Size: **10** and **20** - ISO 5781  
 Max flow: **160** and **300** l/min

Max pressure: **250 bar**

### 1 MODEL CODE

<b>RZGA</b>	/	*	-	A	-	010	/	250	/	M	/	*	/	*	**	/	*
Ex-proof proportional pressure reducing valves  <b>RZGA</b> = subplate size 06 <b>HZGA</b> = modular size 06 <b>KZGA</b> = modular size 10 <b>AGRCZA</b> = subplate size 10, 20  <b>Certification type</b> Multicertification: - = omit for Group II 2G / 2D (1) <b>M</b> = Group I M2 (mining) North American Certification: <b>UL</b> = cULus  A = without transducer  <b>Valve size and configuration:</b> <b>010</b> = RZGA direct size 06 Qmax 12 l/min <b>033</b> = RZGA piloted size 06 Qmax 40 l/min <b>031</b> = HZGA piloted size 06 Qmax 40 l/min <b>031</b> = KZGA piloted size 10 Qmax 100 l/min <b>10</b> = AGRCZA piloted size 10 Qmax 160 l/min <b>20</b> = AGRCZA piloted size 20 Qmax 300 l/min																	* <b>Seals material</b> , see section 7: - = NBR <b>PE</b> = FKM <b>BT</b> = HNBR (2)
																* <b>Voltage code:</b> - = standard coil for 24 Vdc Atos drivers <b>24</b> = with 24 VDC coils	
																* <b>Options (3):</b> <b>O</b> = horizontal cable entrance (2) <b>P</b> = with integral mechanical pressure limiter (only for AGRCZA) <b>R</b> = with check valve (only for AGRCZA)	
																* <b>Solenoid threaded connection</b> for cable gland fitting: <b>GK</b> = GK-1/2" - not for cULus (4) <b>M</b> = M20x1,5 - not for cULus <b>NPT</b> = 1/2" NPT	
																* <b>Max regulated pressure:</b> for all versions except RZGA-010 <b>80</b> = 80 bar <b>180</b> = 180 bar <b>250</b> = 250 bar only for RZGA-010 <b>32</b> = 32 bar <b>100</b> = 100 bar <b>210</b> = 210 bar	

(1) The valves with Multicertification for Group II are also certified for Indian market according to **PESO** (Petroleum and Explosives Safety Organization). The PESO certificate can be downloaded from [www.atos.com](http://www.atos.com)  
 (2) Not for multicertification **M** group I (mining) (3) Possible combined options: /OP, /OR, /PR, /OPR (4) Approved only for the Italian market

### 2 CONFIGURATIONS AND HYDRAULIC SYMBOLS (representation according to ISO 1219-1)

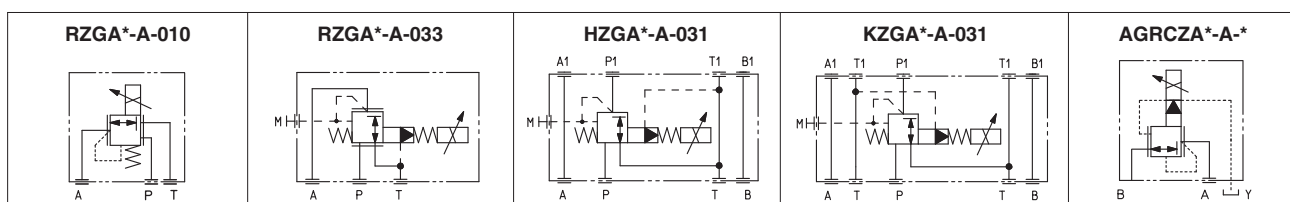

### 3 ELECTRONIC DRIVERS

Electronic drivers are factory set with max current limitation for ex-proof valves.

Please include in the driver order also the complete code of the connected ex-proof proportional valve.

Drivers model	E-BM-AS-* /A	E-BM-AES-* /A
Type	digital	digital
Format	DIN-rail panel	
Data sheet	G030	GS050

### 4 GENERAL CHARACTERISTICS

Assembly position	Any position
Subplate surface finishing to ISO 4401	Acceptable roughness index, Ra ≤0,8 recommended Ra 0,4 - flatness ratio 0,01/100
MTTFd valves according to EN ISO 13849	75 years; 150 years only for RZGA-010, see technical table P007
Ambient temperature range	<b>Standard</b> = -20°C ÷ +70°C / <b>PE</b> option = -20°C ÷ +70°C / <b>BT</b> option = -40°C ÷ +70°C
Storage temperature range	<b>Standard</b> = -20°C ÷ +80°C / <b>PE</b> option = -20°C ÷ +80°C / <b>BT</b> option = -40°C ÷ +70°C
Surface protection	Zinc coating with black passivation - salt spray test (EN ISO 9227) > 200h
Compliance	Explosion proof protection, see section <a href="#">8</a> -Flame proof enclosure "Ex d" -Dust ignition protection by enclosure "Ex t" RoHs Directive 2011/65/EU as last update by 2015/65/EU REACH Regulation (EC) n°1907/2006

### 5 HYDRAULIC CHARACTERISTICS - based on mineral oil ISO VG 46 at 50 °C

Valve model	RZGA		HZGA	KZGA	AGRCZA	
Size code	010	033	031		10	20
Valve size	06		10		20	
Max regulated pressure [bar]	<b>32; 100; 210</b>		<b>80</b>	<b>180</b>	<b>250</b>	
Max pressure at port P, A, B, X [bar]			315			
Max pressure at port T, Y [bar]			210			
Max flow [l/min]	12	40	40	100	160	300
Response time 0-100% step signal (depending on installation) <b>(1)</b> [ms]			≤ 70			
Hysteresis[% of the max pressure]			≤ 1,5			
Linearity[% of the max pressure]			≤ 3			
Repeatability[% of the max pressure]			≤ 2			

**Note:** above performance data refer to valves coupled with Atos electronic drivers, see section [3](#)

**(1)** Average response time value; the pressure variation in consequence of a modification of the reference input signal to the valve is affected by the stiffness of the hydraulic circuit: greater is the stiffness of the circuit, faster is the dynamic response

### 6 ELECTRICAL CHARACTERISTICS

Max. power	35W	
Insulation class	H (180°) Due to the occurring surface temperatures of the solenoid coils, the European standards ISO 13732-1 and EN982 must be taken into account	
Protection degree with relevant cable gland	<b>Multicertification:</b> IP66/67 to DIN EN60529 <b>UL:</b> raintight enclosure, UL approved	
Duty factor	Continuous rating (ED=100%)	
Voltage code	standard	option /24
Coil resistance R at 20°C	3,2 Ω	17,6 Ω
Max. solenoid current	2,5 A	1,1 A

### 7 SEALS AND HYDRAULIC FLUIDS - for other fluids not included in below table, consult our technical office

Seals, recommended fluid temperature	NBR seals (standard) = -20°C ÷ +60°C, with HFC hydraulic fluids = -20°C ÷ +50°C FKM seals (/PE option) = -20°C ÷ +80°C HNBR seals (/BT option) = -40°C ÷ +60°C, with HFC hydraulic fluids = -40°C ÷ +50°C		
Recommended viscosity	20 ÷ 100 mm <sup>2</sup> /s - max allowed range 15 ÷ 380 mm <sup>2</sup> /s		
Max fluid contamination level	normal operation	ISO4406 class 18/16/13 NAS1638 class 7	see also filter section at
	longer life	ISO4406 class 16/14/11 NAS1638 class 5	www.atos.com or KTF catalog
<b>Hydraulic fluid</b>	<b>Suitable seals type</b>	<b>Classification</b>	<b>Ref. Standard</b>
Mineral oils	NBR, FKM, HNBR	HL, HLP, HLPD, HVLP, HVLPD	DIN 51524
Flame resistant without water	FKM	HFDU, HFDR	ISO 12922
Flame resistant with water <b>(1)</b>	NBR, HNBR	HFC	

 The ignition temperature of the hydraulic fluid must be 50°C higher than the max solenoid surface temperature

#### **(1) Performance limitations in case of flame resistant fluids with water:**

- max operating pressure = 210 bar
- max fluid temperature = 50°C

**8 CERTIFICATION DATA**

Valve type	RZMA, HZMA, AGMZA		RZMA/M, HZMA/M, AGMZA/M	RZMA/UL, HZMA/UL, AGMZA/UL	
Certifications	Multicertification Group II <b>ATEX IECEX EAC PESO</b>		Multicertification Group I <b>ATEX IECEX</b>	North American <b>cULus</b>	
Solenoid certified code	<b>MZA-A</b>		<b>MZAM-A</b>	<b>OZA-A/EC</b>	
Type examination certificate (1)	ATEX: CESI 02 ATEX 014 IECEX: IECEX CES 10.0010x EAC: TC RU C-IT. 08.B.01784 PESO: P338131		ATEX: CESI 03 ATEX 057x IECEX: IECEX CES 12.0007x	20170324 - E366100	
Method of protection	<ul style="list-style-type: none"> <li>• ATEX, EAC Ex II 2G Ex d IIC T4/T3 Gb Ex II 2D Ex tb IIIC T135°C/T200°C Db</li> <li>• IECEX Ex d IIC T4/T3 Gb Ex tb IIIC T135°C/T200°C Db</li> <li>• PESO Ex II 2G Ex d IIC T4/T3 Gb</li> </ul>		<ul style="list-style-type: none"> <li>• ATEX Ex I M2 Ex db I Mb</li> <li>• IECEX Ex db I Mb</li> </ul>	<ul style="list-style-type: none"> <li>• UL 1203 Class I, Div.I, Groups C &amp; D Class I, Zone I, Groups IIA &amp; IIB</li> </ul>	
Temperature class	<b>T4</b>	<b>T3</b>	-	<b>T4</b>	<b>T3</b>
Surface temperature	≤ 135 °C	≤ 200 °C	≤ 150 °C	≤ 135 °C	≤ 200 °C
Ambient temperature (2)	-40 ÷ +40 °C	-40 ÷ +70 °C	-20 ÷ +60 °C	-40 ÷ +55 °C	-40 ÷ +70 °C
Applicable standards	EN 60079-0: 2012+A11:2013 EN 60079-1:2014 EN 60079-31:2014		IEC 60079-0:2017 IEC 60079-1:2017-04 IEC 60079-31:2013	UL 1203 and UL429, CSA 22.2 n°30-1986 CSA 22.2 n°139-13	
Cable entrance: threaded connection vertical (standard) or horizontal (option /O)	<b>GK</b> = GK-1/2" <b>M</b> = M20x1,5 <b>NPT</b> = 1/2" NPT			1/2" NPT	

(1) The type examiner certificates can be downloaded from [www.atos.com](http://www.atos.com)

(2) The solenoids **Group II** and **cULus** are certified for minimum ambient temperature -40°C  
In case the complete valve must withstand with minimum ambient temperature of -40°C, select **/BT** in the model code

**⚠ WARNING: service work performed on the valve by the end users or not qualified personnel invalidates the certification**

**9 EX PROOF SOLENOIDS WIRING**

**Multicertification**

**Standard version**                      **Option /O**

① cover with threaded connection for vertical cable gland fitting  
 ② cover with threaded connection for horizontal cable gland fitting  
 ③ terminal board for cables wiring  
 ④ screw terminal for additional equipotential grounding

**1** = Coil    PCB 3 poles terminal board suitable for wires cross sections up to 2,5 mm<sup>2</sup> (max AWG14)  
**2** = GND  
**3** = Coil

**cULus certification**

**Standard version**                      **Option /O**

① cover with threaded connection for vertical cable gland fitting  
 ② cover with threaded connection for horizontal cable gland fitting  
 ③ terminal board for cables wiring

**⚠ Pay attention to respect the polarity**

**1** = Coil +    PCB 3 poles terminal board suggested cable section up to 1,5 mm<sup>2</sup> (max AWG16), see section 10 note 1  
**2** = GND  
**3** = Coil -

alternative GND screw terminal connected to solenoid housing

**10 CABLE SPECIFICATION AND TEMPERATURE** - Power supply and grounding cables have to comply with following characteristics:

<b>Multicertification Group I and Group II</b>	
<b>Power supply:</b> section of coil connection wires = 2,5 mm <sup>2</sup>	<b>Grounding:</b> section of internal ground wire = 2,5 mm <sup>2</sup> section of external ground wire = 4 mm <sup>2</sup>
<b>cULus certification:</b>	
<ul style="list-style-type: none"> <li>Suitable for use in Class I Division 1, Gas Groups C</li> <li>Armored Marine Shipboard Cable which meets UL 1309</li> <li>Tinned Stranded Copper Conductors</li> <li>Bronze braided armor</li> <li>Overall impervious sheath over the armor</li> </ul>	
Any Listed (UBVZ/UBVZ7) Marine Shipboard Cable rated 300 V min, 15A min. 3C 2,5 mm <sup>2</sup> (14 AWG) having a suitable service temperature range of at least -25°C to +110°C ("BT" Models require a temperature range from -40°C to +110°C)	
<b>Note 1:</b> For Class I wiring the 3C 1,5 mm <sup>2</sup> AWG 16 cable size is admitted only if a fuse lower than 10 A is connected to the load side of the solenoid wiring.	

**10.1 Cable temperature**

The cable must be suitable for the working temperature as specified in the "safety instructions" delivered with the first supply of the products.

**Multicertification**

Max ambient temperature [°C]	Temperature class		Max surface temperature [°C]		Min. cable temperature [°C]	
	Goup I	Goup II	Goup I	Goup II	Goup I	Goup II
40 °C	-	T4	150 °C	-	90 °C	-
45 °C	-	T4	150 °C	135 °C	-	90 °C
55 °C	-	T3	150 °C	200 °C	-	110 °C
60 °C	-	-	150 °C	-	110 °C	-
70 °C	N.A.	T3	N.A.	200 °C	N.A.	120 °C

**cULus certification**

Max ambient temperature [°C]	Temperature class	Max surface temperature [°C]	Min. cable temperature
55 °C	T4	135 °C	100 °C
70 °C	T3	200 °C	100 °C

**11 CABLE GLANDS** - only **Multicertification**

Cable glands with threaded connections GK-1/2", 1/2"NPT or M20x1,5 for standard or armored cables have to be ordered separately, see tech. table **KX800**

**Note:** a Loctite sealant type 545, should be used on the cable gland entry threads

**12 OPTIONS**

**O** = Horizontal cable entrance, to be selected in case of limited vertical space.

**P** = Integral mechanical pressure limiter

The AGRCZA-\*/**P** are provided with mechanical pressure limiter acting as protection against overpressure. For safety reasons the factory setting of the mechanical pressure limiter is fully unloaded (min pressure).

At the first commissioning it must be set at a value lightly higher than the max pressure regulated with the proportional control.

For the pressure setting of the mechanical pressure limiter, proceed according to following steps:

- apply the max reference input signal to the valve's driver. The system pressure will not increase until the mechanical pressure limiter remains unloaded.
- turn clockwise the adjustment screw ① until the system pressure will increase up to a stable value corresponding to the pressure setpoint at max reference input signal.
- turn clockwise the adjustment screw ① of additional 1 or 2 turns to ensure that the mechanical pressure limiter remains closed during the proportional valve working.

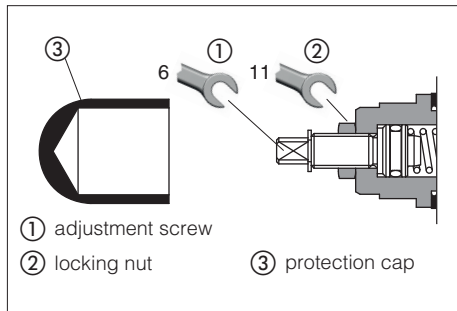

**R** = Integral check valve for free reverse flow

The AGRCZA-\*/**R** are provided with integral check valve for free reverse flow A→B

- ① Check valve - cracking pressure = 0,5 bar
- ② Plug

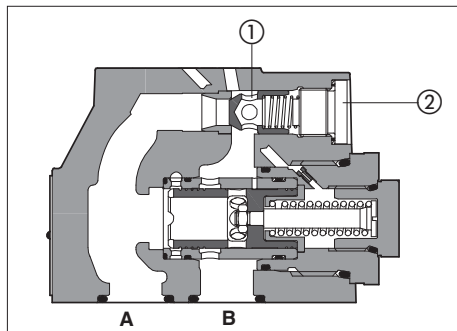

**12.1 Possible combined options:** /OP, /OR, /PR, /OPR

**13 DIAGRAMS RZGA-010** (based on mineral oil ISO VG 46 at 50 °C)

**1 Regulation diagrams**  
with flow rate  $Q = 1$  l/min

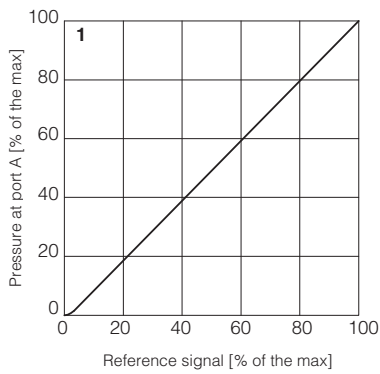

**2 Pressure/flow diagrams**  
with reference signal set at  $Q = 1$  l/min

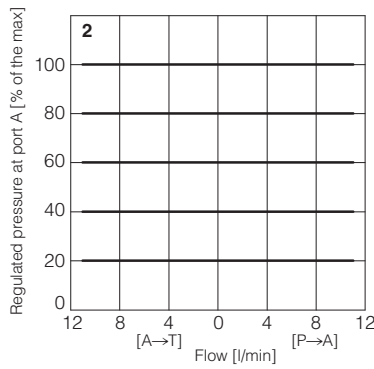

**3-4 Min. pressure/flow diagrams**  
with zero reference signal

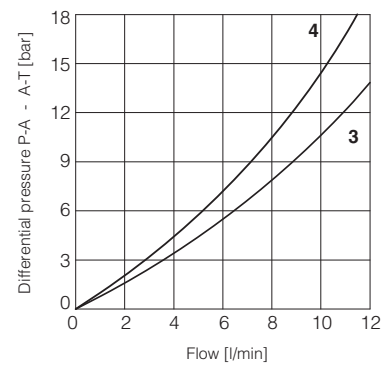

**3** = Pressure drops vs. flow P→A  
**4** = Pressure drops vs. flow A→T

**14 DIAGRAMS RZGA-033, HZGA, KZGA** (based on mineral oil ISO VG 46 at 50 °C)

**14.1 Regulation diagrams**  
with flow rate  $Q = 10$  l/min

**1** = RZGA, HZGA  
**2** = KZGA

**Note:**

The presence of counter pressure at port T can affect the effective pressure regulation.

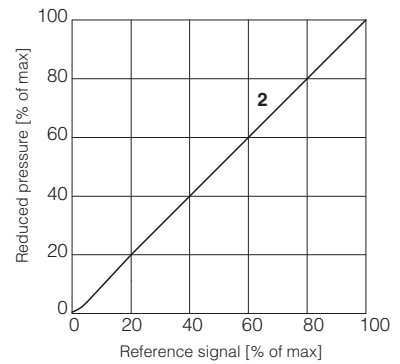
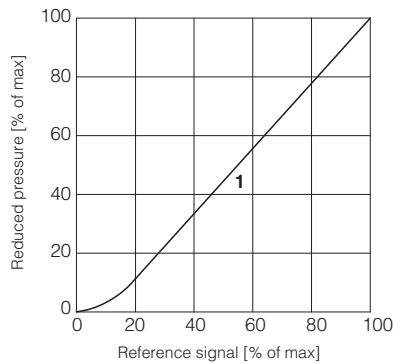

**14.2 Pressure/flow diagrams**  
with reference pressure set with  $Q = 10$  l/min

**3** = RZGA, KZGA

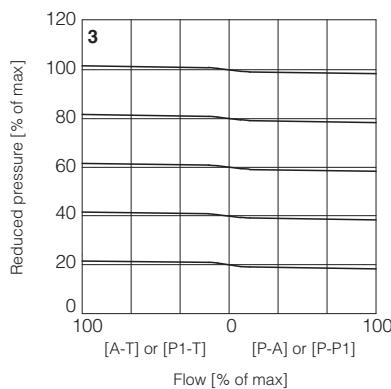

**14.3 Pressure drop/flow diagram**

RZGA, HZGA

**4** = A-T or P1-T

**5** = P-P1 or P-A

KZGA

**6** = P1-T

**7** = P-P1

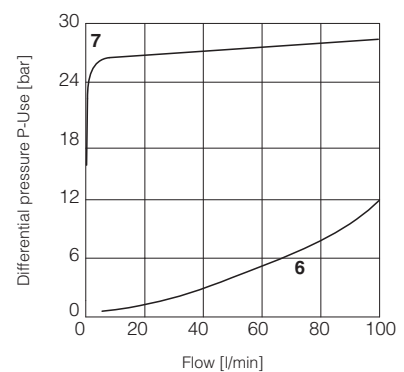
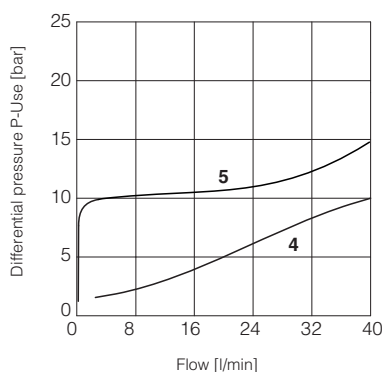

**15 DIAGRAMS AGRCZA** (based on mineral oil ISO VG 46 at 50 °C)

**1 Regulation diagrams**  
with flow rate Q = 10 l/min

**2 Pressure/flow diagrams**  
with reference pressure set with Q = 10 l/min

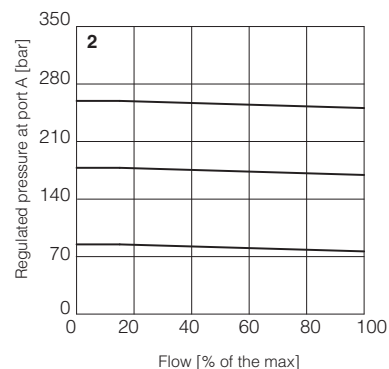
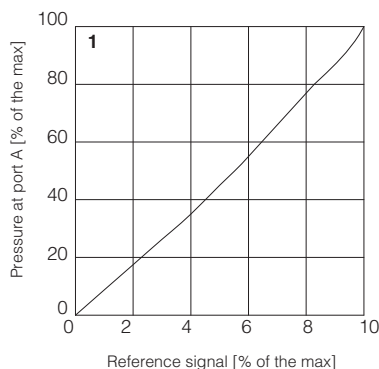

**3-6 Pressure drop/flow diagrams**  
with zero reference signal

Differential pressure B→A

**3** = AGRCZA\*-10

**4** = AGRCZA\*-20

Differential pressure A→B (through check valve)

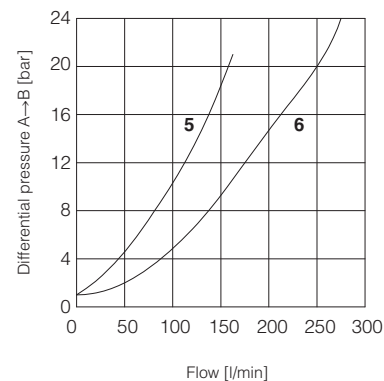
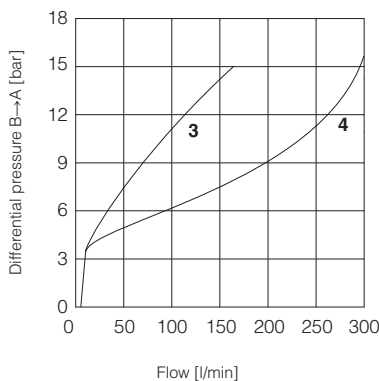

**5** = AGRCZA\*-10\*/R

**6** = AGRCZA\*-20\*/R



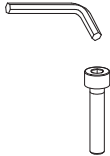

**16 FASTENING BOLTS AND SEALS**

**16.1 RZGA, HZGA and KZGA valves**

	<b>RZGA-A-010</b>	<b>RZGA-A-033</b>	<b>HZGA-A-031</b>	<b>KZGA-A-031</b>
	<b>Fastening bolts:</b> 4 socket head screws M5x50 class 12.9 Tightening torque = 8 Nm	<b>Fastening bolts:</b> 4 socket head screws M5x50 class 12.9 Tightening torque = 8 Nm	<b>Fastening bolts:</b> 4 socket head screws M5 class 12.9 Tightening torque = 8 Nm	<b>Fastening bolts:</b> 4 socket head screws M6 class 12.9 Tightening torque = 16 Nm
	<b>Seals:</b> 2 OR 108 Diameter of ports P, T: Ø 5 mm (max)	<b>Seals:</b> 4 OR 108 Diameter of ports P, T: Ø 7,5 mm (max)	<b>Seals:</b> 4 OR 108 Diameter of ports P, T: Ø 7,5 mm	<b>Seals:</b> 5 OR 2050 Diameter of ports P, A, B, T: Ø 11,5 mm (max) 1 OR 108 Diameter of port Y: Ø 5 mm

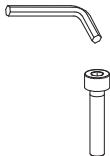
**16.2 AGRCZA valves**

	<b>AGRCZA-A-10</b>	<b>AGRCZA-A-20</b>
	<b>Fastening bolts:</b> 4 socket head screws M110x45 class 12.9 Tightening torque = 70 Nm	<b>Fastening bolts:</b> 4 socket head screws M110x45 class 12.9 Tightening torque = 70 Nm
	<b>Seals:</b> 2 OR 3068 Diameter of ports A, B: Ø 14 mm 2 OR 109/70 Diameter of ports X, Y: Ø 5 mm	<b>Seals:</b> 2 OR 4100 Diameter of ports A, B: Ø 22 mm 2 OR 109/70 Diameter of ports X, Y: Ø 5 mm

17 INSTALLATION DIMENSIONS FOR RZGA [mm]

**RZGA-A-010**

ISO 4401: 2005 (see table P005)  
 Mounting surface: 4401-03-02-0-05  
 (without port B)

Mass [kg]	
RZGA-A-010	2,7
Option /O	+0,35

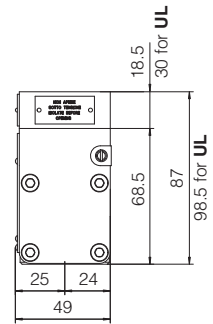
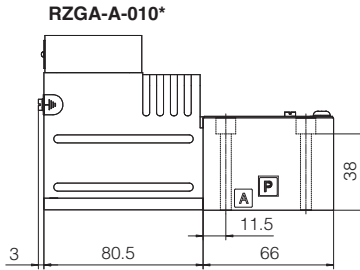
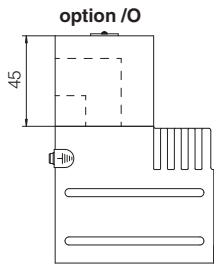

**RZGA-A-033**

ISO 4401: 2005 (see table P005)  
 Mounting surface: 4401-03-02-0-05  
 (ports A and B connected to port T)

Mass [kg]	
RZGA-A-033	3,7
Option /O	+0,35

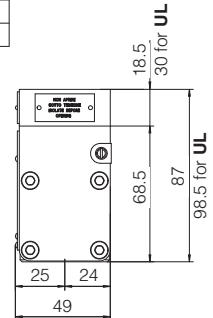
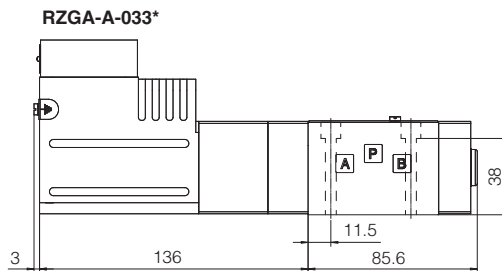
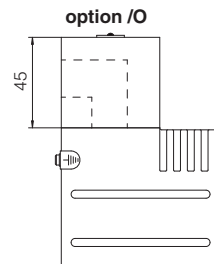

18 INSTALLATION DIMENSIONS FOR HZGA and KZGA [mm]

**HZGA-A-031**

ISO 4401: 2005 (see table P005)  
 Mounting surface: 4401-03-02-0-05  
 (ports A and B connected to port T)

Mass [kg]	
HZGA-A-031	3,7
Option /O	+0,35

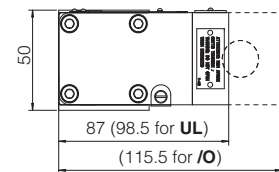
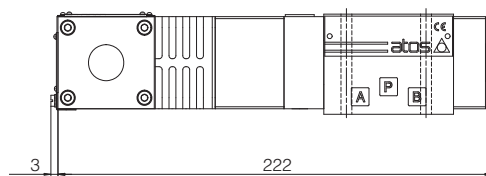
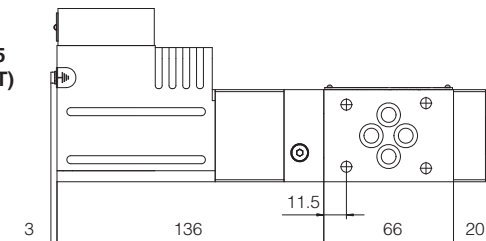

**KZGA-A-031**

ISO 4401: 2005 (see table P005)  
 Mounting surface: 4401-05-05-0-05  
 (without X port, Y port optional)

Mass [kg]	
KZGA-A-031	3,7
Option /O	+0,35

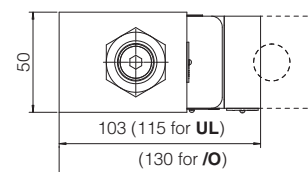
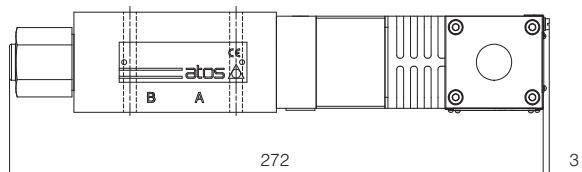
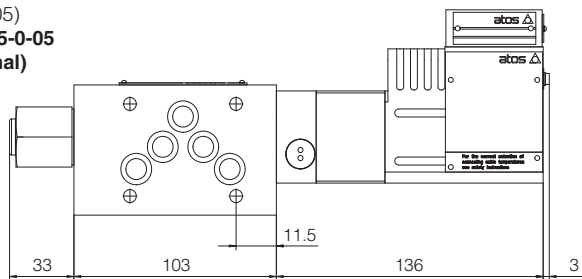

19 INSTALLATION DIMENSIONS FOR AGRCZA [mm]

**AGRCZA-A-10**

ISO 5781: 2000 (see table P005)  
 Mounting surface: 5781-06-07-0-00

Mass [kg]	
AGRCZA-A-10	5,7
Option /P	+0,5

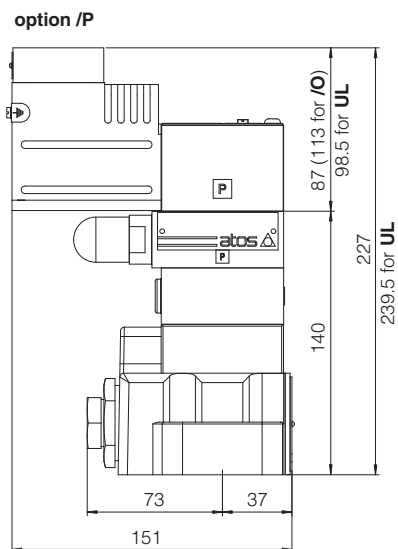
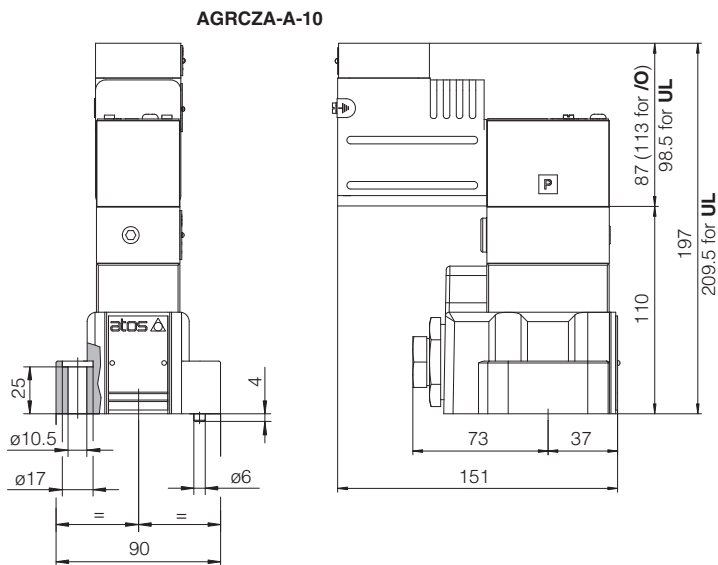

**AGRCZA-A-20**

ISO 5781: 2000 (see table P005)  
 Mounting surface: 5781-08-10-0-00

Mass [kg]	
AGRCZA-A-20	8,2
Option /P	+0,5

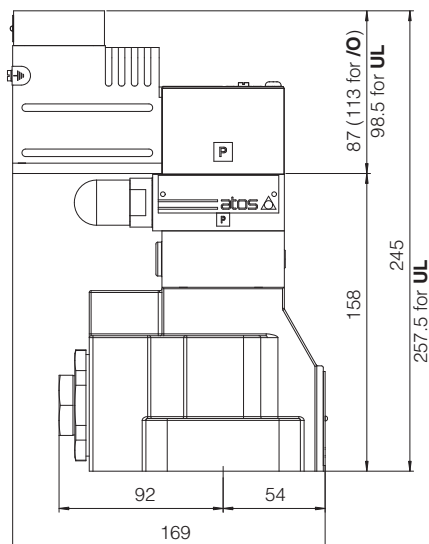
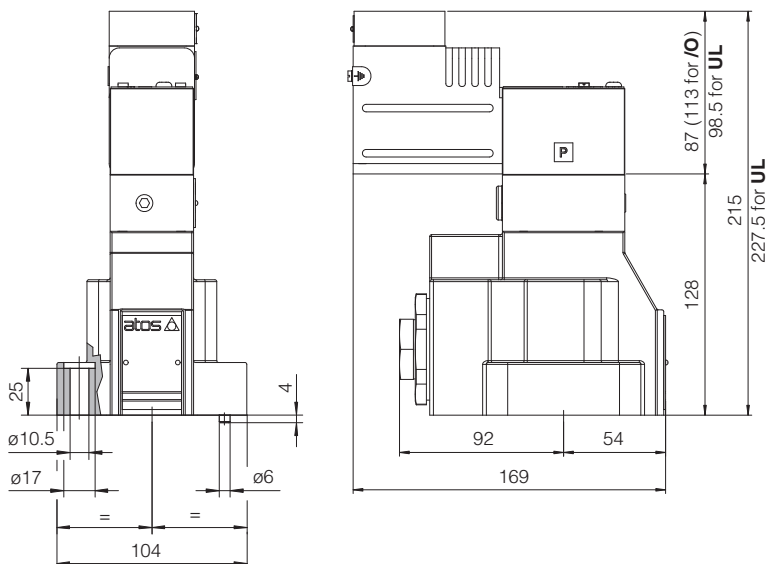

20 RELATED DOCUMENTATION

- X010** Basics for electrohydraulics in hazardous environments
- X020** Summary of Atos ex-proof components certified to ATEX, IECEx, EAC, PESO
- X030** Summary of Atos ex-proof components certified to cULus
- FX900** Operating and maintenance norms for ex-proof proportional valves
- KX800** Cable glands for ex-proof valves
- P005** Mounting surfaces for electrohydraulic valves