

Stainless steel ex-proof solenoid directional valves

on-off, direct, spool type - **ATEX, IECEx, EAC, PESO, CCC or cULus**

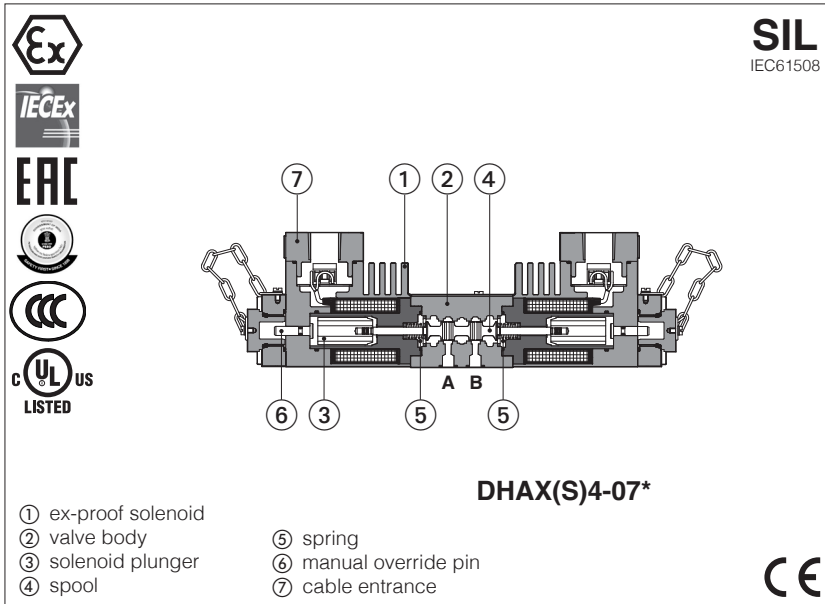

DHAX, DHAXS

Ex-proof, spool type, directional solenoid valves made in two different stainless steel executions for corrosive environments and fluids.

- **X** full stainless steel for external and internal parts, to withstand extreme and corrosive environmental conditions, and to ensure full compatibility also with water base and special fluids.
- **XS** stainless steel only for external parts to withstand extreme and corrosive environmental conditions.

Ex-proof stainless steel solenoids are provided, with **ATEX, IECEx, EAC, PESO, CCC Multicertification or cULus** North American certification, see sect. 8.

DHAX and DHAXS are **SIL** compliance with IEC 61508 (TÜV certified)

Size: **06** - ISO 4401

4/3 and 4/2 way

Max flow: up to **70 l/min**

Max pressure: **350 bar**

1 MODEL CODE

DHA	X	4	/	*	-	0	63	1/2	/	M	/	V	24DC	*	/	*	/	*	
Ex-proof solenoid directional valve, direct, spool type																			Test fluid , only for X execution (3): H = mineral oil W = pure water
Stainless steel executions (1) X = full stainless steel XS = stainless steel only external parts																			Seals material , see section 6: - = NBR low temp. -40°C PE = FKM BBT = FVMQ fluorosilicon -60°C (4)
Solenoid power and Temperature class , see also certification data in section 8 (2): Multicertification 4 = 25W, class T4/T3 6 = 8W, class T6/T4 (only XS execution) cULus 4 = 33W, class T3 6 = 12W, class T6/T5																			Series number
Certification type : - = omit for Multicertification (Group II) North American Certification: UL = cULus																			Voltage code , see section 5
Valve size (ISO 4401): 0 = 06																			Options , see section 13 for possible combined option: A = solenoid at side of port B O = horizontal cable entrance V = with handwheel manual override
Configuration , see section 2: 61, 63, 71, 75																			Solenoid threaded connection for cable gland fitting: M = M20x1,5 for Multicertification NPT = 1/2" NPT for /UL
																			Spool type - see section 2

(1) See section 6 for materials specification.

(2) 6 and 4 versions differ only for the coil power, see power consumption at section 5 and operating limits at section 15.

(3) DHAX valves in full stainless steel execution are factory tested with mineral oil or pure water in order to avoid the contamination of the end user system. At the end of each valve model code must be specified the type of fluid to be used in the valve's testing: "H" for hydraulic oil or "W" for pure water.

(4) Only for Multicertified valves in full stainless steel "X" execution (not available for valves with UL certification)

1.1 Summary of available models

Valve execution		Multicertification		cULus		Max flow (l/min)	Max pressure (bar)
X	XS	Tclass	Power	Tclass	Power		
DHAX4	DHAXS4	T4, T3	25W	T3	33W	70	350
-	DHAXS6	T6, T4	8W	T6, T5	12W	60	

2 CONFIGURATIONS AND SPOOLS (representation according to ISO 1219-1)

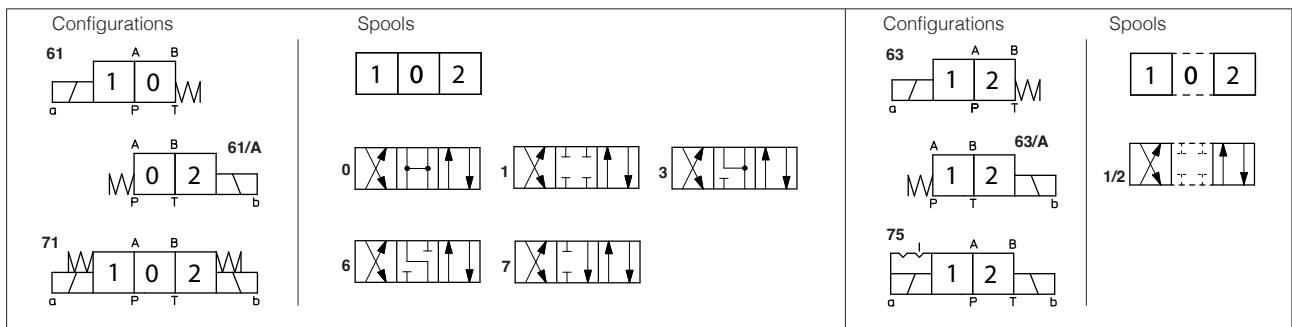

3 GENERAL CHARACTERISTICS

Assembly position / location	Any position
Subplate surface finishing	Roughness index Ra 0,4 - flatness ratio 0,01/100 (ISO 1101)
MTTFd values according to EN ISO 13849	150 years, for further details see technical table P007
Ambient temperature	Standard = -40°C ÷ +70°C /PE option = -20°C ÷ +70°C /BBT option = -60°C ÷ +70°C
Storage temperature range	Standard = -40°C ÷ +80°C /PE option = -20°C ÷ +80°C /BBT option = -60°C ÷ +80°C
Compliance	Explosion proof protection, see section 8 -Flame proof enclosure "Ex d" -Dust ignition protection by enclosure "Ex t" SIL to IEC 61508: 2010, see section 9 RoHs Directive 2011/65/EU as last update by 2015/863/EU REACH Regulation (EC) n°1907/2006

4 HYDRAULIC CHARACTERISTICS

Max operating pressure	Ports P,A,B: 350 bar; Port T 210 bar
Rated flow	See diagrams Q/Δp at section 14
Max flow	DHAX4 = 70 l/min DHAXS4 = 70 l/min DHAXS6 = 60 l/min See operating limits at section 15

⚠ The pressure at T port makes difficult the manual override operation that can be possible only if its value is lower than 50 bar

5 ELECTRICAL CHARACTERISTICS

Valve type	DHAX4 DHAXS4	DHAXS6	DHAX4/UL DHAXS4/UL	DHAXS6/UL
Voltage code (1) VDC ±10%	12DC, 24DC, 48DC, 110DC, 125DC, 220DC		12DC, 24DC, 110DC, 125DC, 220DC	
VAC 50/60 Hz ±10%	12AC, 24AC, 110AC, 230AC		12AC, 24AC, 110AC, 230AC	
Power consumption at 20°C	25W	8W	33W	12W
Coil insulation	class H			
Protection degree with relevant cable gland	IP66/67 to DIN EN60529		raintight enclosure, UL approved	
Duty factor	100%			

(1) For alternating current supply a rectifier bridge is provided built-in the solenoid.
 For power supply frequency 60 Hz, the nominal supply voltage of solenoids 110AC and 230AC must be 115/60 and 240/60 respectively

6 MATERIALS SPECIFICATION

Valve code	Solenoid housing	Valve body	Internal parts	Spring	Seals		
					std	/PE	/BBT
DHAX	AISI 630	AISI 316L	AISI 316L, 420B, 440C, 430F	AISI 302	NBR 70 Sh low temp	FKM (viton)	FMVQ (fluorosilicon)
DHAXS	AISI 630	AISI 316L	Carbon steel	AISI 302	NBR 70 Sh low temp	FKM (viton)	-

7 SEALS AND HYDRAULIC FLUIDS - for other fluids not included in below table, consult our technical office

Seals, recommended fluid temperature (1)	NBR low temp. seals (standard) = -40°C ÷ +60°C FKM seals (/PE option) = -20°C ÷ +80°C FVMQ seals (/BBT option) = -60°C ÷ +60°C		
Recommended viscosity	15÷100 mm ² /s - max allowed range 2.8 ÷ 500 mm ² /s min = 0,9 mm ² /s for X full stainless steel execution with pure water		
Max fluid contamination level	ISO4406 class 20/18/15 - NAS1638 class 9, see also filter section at www.atos.com or KTF catalog		
Hydraulic fluid	Suitable seals type	Classification	Ref. Standard
Mineral oils	NBR low temp., FKM, FVMQ	HL, HLP, HLPD, HVLP, HVLDP	DIN 51524
Flame resistant without water	FKM, FVMQ	HFDU, HFDR	ISO 12922
Flame resistant with water (2)	NBR low temp.	HFA-E, HFA-S, HFB, HFC	

(1) The operating temperature of the fluid must be compatible with the maximum viscosity range allowed for the valve

(2) Performance limitations in case of flame resistant fluids with water:
-max operating pressure = 210 bar -max fluid temperature = 50°C

 The ignition temperature of the hydraulic fluid must be 50°C higher than the max solenoid surface temperature

8 CERTIFICATION DATA

8.1 Certification data for ambient temperature range -40 ÷ +70°C

Valve type	DHAX4 DHAXS4		DHAXS6		DHAX4/UL DHAXS4/UL		DHAXS6/UL	
Certifications	Multicertification Group II ATEX IECEx EAC PESO CCC				North American cULus			
Solenoid certified code	OAKX/WP OAKXS/WP		OAXS/WP		OAKX/EC/WP OAKXS/EC/WP		OAXS/EC/WP	
Temperature class	T4	T3	T6	T4	T3	T6	T5	
Surface temperature	≤ 85°C	≤ 135°C	≤ 85°C	≤ 135°C	≤ 200°C	≤ 85°C	≤ 100°C	
Ambient temperature	-40 ÷ +45°C	-40 ÷ +70°C	-40 ÷ +45°C	-40 ÷ +70°C	-40 ÷ +70°C	-40 ÷ +55°C	-40 ÷ +70°C	

8.2 Certification data for ambient temperature range -60 ÷ +70°C (valves with option /BBT)

Valve type	DHAX4 /BBT	
Certifications	Multicertification Group II ATEX IECEx EAC PESO CCC	
Solenoid certified code	OABKX/WP	
Temperature class	T4	T3
Surface temperature	≤ 85°C	≤ 135°C
Ambient temperature	-60 ÷ +45°C	-60 ÷ +70°C

8.3 Certificates and applicable standards

Certifications	Multicertification Group II ATEX IECEx EAC PESO CCC		North American cULus	
Type examination certificate (1)	ATEX: CESI 02 ATEX 014 IECEX: IECEX CES 10.0010x EAC: RU C - IT.AJK38.B.00425/21 PESO: P391133/1 CCC: 2020322307003240		20170324 - E366100	
Method of protection	<ul style="list-style-type: none"> • ATEX Ex II 2G Ex db IIC T6/T4/T3 Gb Ex II 2D Ex tb IIIC T85°C/T200°C Db • IECEx Ex db IIC T6/T4/T3 Gb Ex tb IIIC T85°C/T200°C Db • EAC 1Ex d IIC T6/T4/T3 Gb X Ex tb IIIC T85°C/T200°C Db X • PESO Ex II 2G Exd IIC T6/T4/T3 Gb • CCC Ex d IIC T6/T4/T3 Gb Ex tD A21 IP66/IP67 T85°C/T135°C/T200°C 		<ul style="list-style-type: none"> • UL 1203 Class I, Div.I, Groups C & D Class I, Zone I, Groups IIA & IIB 	
Applicable standards	EN 60079-0 EN 60079-1 EN 60079-31	IEC 60079-0 IEC 60079-1 IEC 60079-31	UL 1203 and UL429, CSA 22.2 n°30-1986 CSA 22.2 n°139-13	
Cable entrance:	M20x1,5		1/2" NPT ANSI/ASME B46.1	

(1) The type examiner certificates can be downloaded from www.atos.com

 **WARNING: service work performed on the valve by the end users or not qualified personnel invalidates the certification**

9 SIL compliance with IEC 61508: 2010

DHAX and DHAXS meets the requirements of:

- **SC3** (systematic capability)
- max **SIL 2** (HFT = 0 if the hydraulic system does not provide the redundancy for the specific safety function where the component is applied)
- max **SIL 3** (HFT = 1 if the hydraulic system provides the redundancy for the specific safety function where the component is applied)

10 EX PROOF SOLENOIDS WIRING

Multicertification

Standard version Option /O

① cover with threaded connection for vertical cable gland fitting
 ② cover with threaded connection for horizontal cable gland fitting
 ③ terminal board for cables wiring
 ④ standard manual override protected by cap
 ⑤ screw terminal for additional equipotential grounding

1	= Coil	PCB 3 poles terminal board
2	= GND	suitable for wires cross sections up to 2,5 mm ² (max AWG14)
3	= Coil	

cULus certification

Standard version Option /O

① cover with threaded connection for vertical cable gland fitting
 ② cover with threaded connection for horizontal cable gland fitting
 ③ terminal board for cables wiring
 ④ standard manual override protected by cap

Pay attention to respect the polarity

1 = Coil + PCB 3 poles terminal board suggest-
 2 = GND ed cable section up to 1,5 mm² (max
 3 = Coil - AWG16), see section 11 note 1

alternative GND screw terminal connected to solenoid housing

11 CABLE SPECIFICATION AND TEMPERATURE

<p>Multicertification</p> <p>Power supply: section of coil connection wires = 2,5 mm² max</p> <p>cULus certification:</p> <ul style="list-style-type: none"> • Suitable for use in Class I Division 1, Gas Groups C • Armored Marine Shipboard Cable which meets UL 1309 • Tinned Stranded Copper Conductors • Bronze braided armor • Overall impervious sheath over the armor 	<p>Grounding: section of internal ground wire = 2,5 mm² max section of external ground wire = 4 mm² min</p> <p>Any Listed (UBVZ/ UBVZ7) Marine Shipboard Cable rated 300 V min, 15A min. 3C 2,5 mm² (14 AWG) having a suitable service temperature range of at least -40°C to +110°C</p> <p>Note 1: For Class I wiring the 3C 1,5 mm² AWG 16 cable size is admitted only if a fuse lower than 10 A is connected to the load side of the solenoid wiring.</p>
---	---

11.1 Cable temperature

The cable must be suitable for the working temperature as specified in the "safety instructions" delivered with the first supply of the products.

Multicertification

Solenoid code	Max ambient temperature [°C]	Temperature class	Max surface temperature [°C]	Min cable temperature
OA(B)X OA(B)XS	45°C	T6	85°C	not prescribed
	70°C	T4	135°C	90°C
OA(B)KX OA(B)KXS	45°C	T4	85°C	100°C
	50°C	T3	200°C	100°C
	60°C	T3	200°C	120°C
	70°C	T3	200°C	130°C

cULus certification

Solenoid code	Max ambient temperature [°C]	Temperature class	Max surface temperature [°C]	Min cable temperature
OAX/EC OAXS/EC	55°C	T6	85°C	100°C
	70°C	T5	100°C	100°C
OAKX/EC OAKXS/EC	55°C	T3	200°C	115°C
	70°C	T3	200°C	140°C

12 CABLE GLANDS - only **Multicertification**

Cable glands with threaded connections M20x1,5 for standard or armoured cables have to be ordered separately, see tech. table **KX800**

Note: a Loctite sealant type 545, should be used on the cable gland entry threads

13 OPTIONS

- A** = solenoid at side of port B (for single solenoid valves)
- O** = horizontal cable entrance, to be selected in case of limited vertical space
- V** = with handwheel manual override

13.1 Possible combined options

AO, AV, OV, AOV

14 Q/Δp DIAGRAMS (based on mineral oil ISO VG 46 at 50°C)

Spool type	Flow direction				
	P→A	P→B	A→T	B→T	P→T
0	A	A	B	B	C
1	C	B	B	B	
3	C	C	A	A	
1/2	C	C	C	C	
6, 7	C	C	C	C	

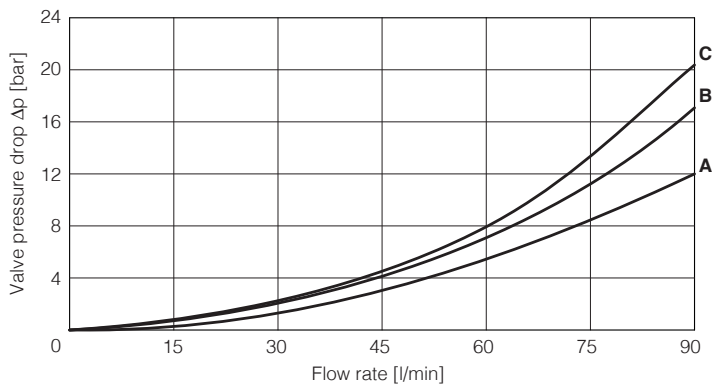

15 OPERATING LIMITS (based on mineral oil ISO VG 46 at 50°C)

The diagram have been obtained with warm solenoids and power supply at lowest value ($V_{nom} - 10\%$). The curves refer to application with symmetrical flow through the valve (i.e. P → A and B → T). In case of asymmetric flow the operating limits must be reduced.

Valve type	Curve	Spool type
DHAX4	A	0, 1
	B	3
	C	1/2
	D	6, 7

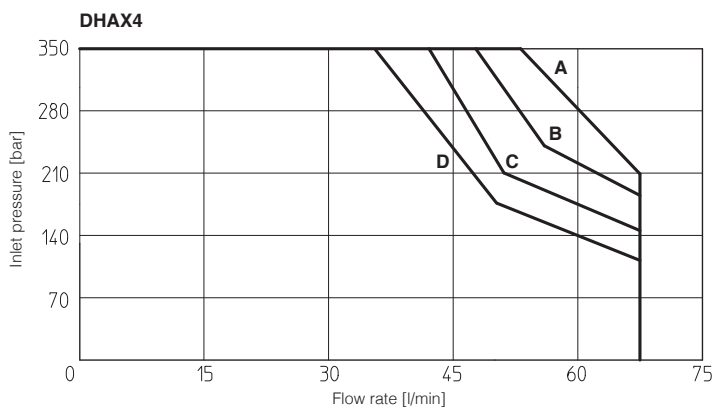

Valve type	Curve	Spool type
DHAXS4	A	0, 1, 3
	B	1/2
	C	6, 7

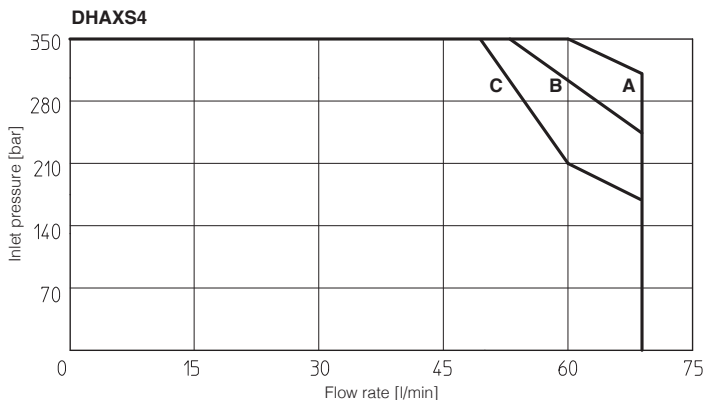

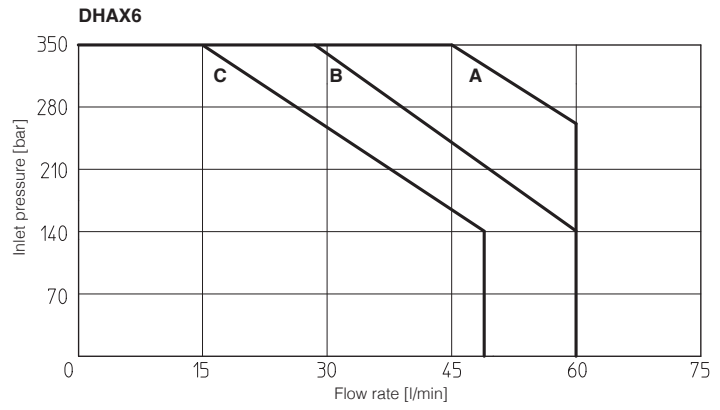

Valve type	Curve	Spool type
DHAX6	A	0
	B	1, 1/2
	C	3, 6, 7

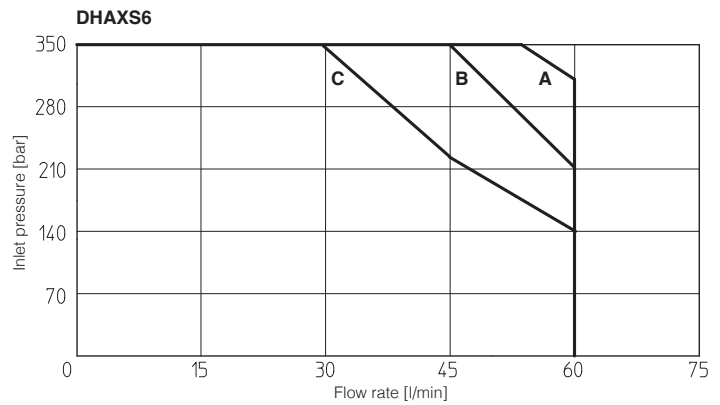

Valve type	Curve	Spool type
DHAXS6	A	0
	B	1, 1/2
	C	3, 6, 7

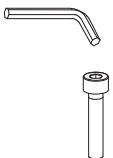

16 FASTENING BOLTS AND SEALS

	<p>DHAX, DHAXS</p> <p>Fastening bolts: 4 socket head screws M5x50-A4-70 Tightening torque = 5,5 Nm</p>
	<p>Seals: 4 OR 108; Diameter of ports P, A, B, T: Ø 7,5 mm (max)</p>

17 INSTALLATION DIMENSIONS [mm]

ISO 4401: 2005
Mounting surface: 4401-03-02-0-05

Mass [kg]	
DHAX(S)**-06*	2,9
DHAX(S)**-06*/V	3
DHAX(S)**-07*	4,6
DHAX(S)**-07*/V	4,8
Option /O	+0,35

valve's bottom view

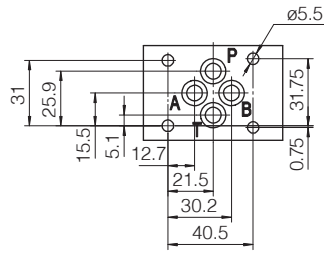

P = PRESSURE PORT
A, B = USE PORT
T = TANK PORT

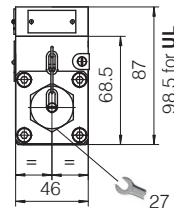
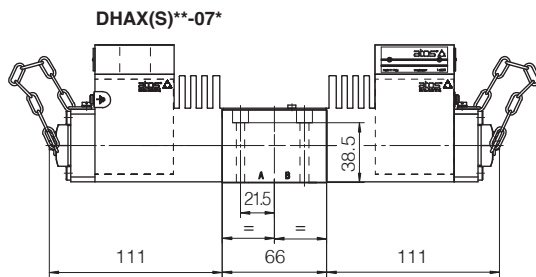
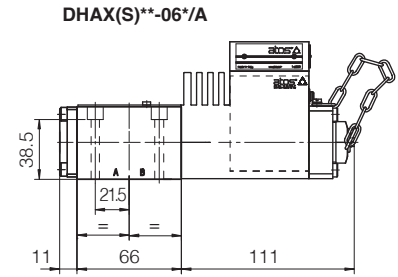
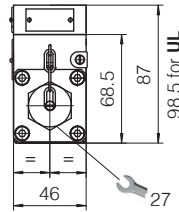
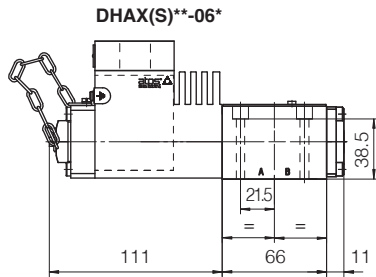

handwheel manual override option /V

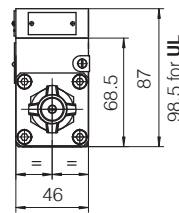
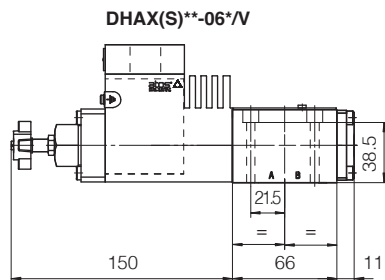

horizontal cable entrance option /O

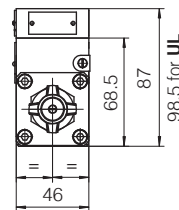
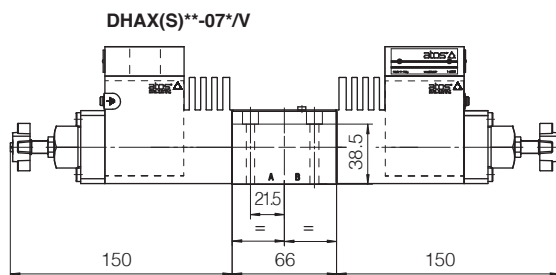
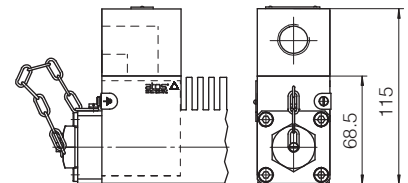

18 RELATED DOCUMENTATION

W010	Basics for electrohydraulics in corrosive environments	X010	Basics for electrohydraulics in hazardous environments
W020	Summary of Atos stainless steel components	KX800	Cable glands for ex-proof valves
EW900	Operating and maintenance information for stainless steel on-off valves	P005	Mounting surfaces for electrohydraulic valves