

Ex-proof proportional directional valves high performance

direct, with LVDT transducer and zero spool overlap - **ATEX, IECEx, EAC, PESO, CCC** or **cULus**

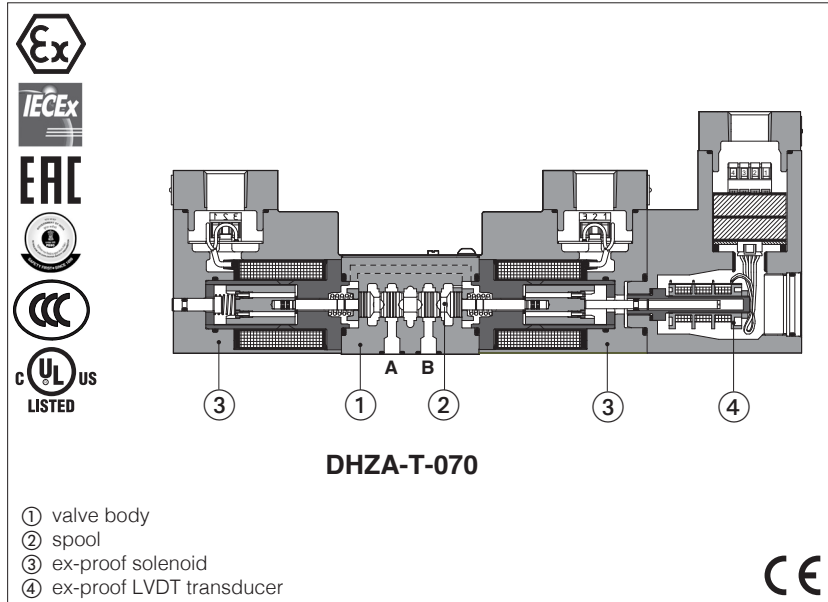

DHZA-T, DKZA-T

Ex-proof high performance proportional valves direct, with LVDT position transducer and zero spool overlap, for positive closed loop controls.

They are equipped with ex-proof proportional solenoids and LVDT transducer certified for safe operations in hazardous environments with potentially explosive atmosphere.

Certifications:



- Multicertification **ATEX, IECEx, EAC, PESO, CCC** for gas group **II 2G** and dust category **II 2D**
- Multicertification **ATEX** and **IECEx** for gas group **I M2** (mining)
- **cULus** North American certification for gas group **C&D**

The flameproof enclosure of solenoid and transducer, prevents the propagation of accidental internal sparks or fire to the external environment.

The solenoids are also designed to limit the surface temperature within the classified limits.

DHZA:	DKZA:
Size: 06 - ISO 4401	Size: 10 - ISO 4401
Max flow: 60 l/min	Max flow: 150 l/min
Max pressure: 350 bar	Max pressure: 315 bar

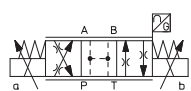
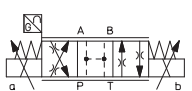
1 MODEL CODE

DHZA	/	*	-	T	-	0	70	-	L	5	/	M	/	*	/	*	/	*									
<p>Ex-proof proportional directional valves, direct</p> <p>DHZA = size 06 DKZA = size 10</p> <p>Certification type: Multicertification ATEX, IECEx, EAC, PESO, CCC: - = omit for Group II 2G / 2D M = Group I (mining) North American Certification: UL = cULus</p> <p>T = with LVDT transducer</p> <p>Valve size ISO 4401: 0 = 06 1 = 10</p> <p>Configuration:</p> <div style="display: flex; justify-content: space-around;"> <div style="text-align: center;"> <p>Standard</p>  </div> <div style="text-align: center;"> <p>Option /B</p>  </div> </div> <p>Spool type, regulating characteristics: L = linear D = differential-progressive</p> <div style="display: flex; justify-content: space-around;">   </div> <p>P-A = Q, B-T = Q/2 P-B = Q/2, A-T = Q</p>																											
<p>Seals material, see section 6 :</p> <p>- = NBR PE = FKM BT = HNBR (1)</p> <p>Series number</p> <p>Options (2): B = solenoid and position transducer at side of port A C = position transducer with current feedback 4÷20 mA Y = external drain</p> <p>Solenoid and transducer threaded connection for cable gland fitting: GK = GK-1/2" - not for cULus (3) M = M20x1,5 - not for cULus NPT = 1/2" NPT</p> <table border="0" style="width: 100%;"> <tr> <td>Spool size:</td> <td>3 (L)</td> <td>5 (L,D)</td> </tr> <tr> <td>DHZA</td> <td>= 17</td> <td>28</td> </tr> <tr> <td>DKZA</td> <td>= 45</td> <td>75</td> </tr> </table> <p>Nominal flow (l/min) at Δp 10bar P-T</p>																			Spool size:	3 (L)	5 (L,D)	DHZA	= 17	28	DKZA	= 45	75
Spool size:	3 (L)	5 (L,D)																									
DHZA	= 17	28																									
DKZA	= 45	75																									

(1) Not for multicertification **M** group I (mining) (2) Possible combined options: /BC, /BY, /CY, /BCY (3) Approved only for the Italian market

2 OFF-BOARD ELECTRONIC DRIVERS

Electronic drivers are factory set with max current limitation for ex-proof valves.

Please include in the driver order also the complete code of the connected ex-proof proportional valve.

Drivers model	E-BM-TEB-* /A	E-BM-TES-* /A
Type	digital	digital
Format	DIN-rail panel	
Data sheet	GS230	GS240

3 GENERAL CHARACTERISTICS

Assembly position	Any position
Subplate surface finishing to ISO 4401	Acceptable roughness index, Ra ≤0,8 recommended Ra 0,4 - flatness ratio 0,01/100
MTTFd valves according to EN ISO 13849	150 years, see technical table P007
Ambient temperature range	Standard = -20°C ÷ +70°C / PE option = -20°C ÷ +70°C / BT option = -40°C ÷ +60°C
Storage temperature range	Standard = -20°C ÷ +80°C / PE option = -20°C ÷ +80°C / BT option = -40°C ÷ +70°C
Surface protection	Zinc coating with black passivation - salt spray test (EN ISO 9227) > 200h
Compliance	Explosion proof protection, see section 7 -Flame proof enclosure "Ex d" -Dust ignition protection by enclosure "Ex t" RoHs Directive 2011/65/EU as last update by 2015/863/EU REACH Regulation (EC) n°1907/2006

4 HYDRAULIC CHARACTERISTICS - based on mineral oil ISO VG 46 at 50 °C

Valve model	DHZA			DKZA		
	ports P, A, B = 350; T = 210 (250 with external drain /Y) Y = 10			ports P, A, B = 315; T = 210 (250 with external drain /Y) Y = 10		
Pressure limits [bar]	L3	L5	D5	L3	L5	D5
Spool type						
Nominal flow Δp P-T [l/min]						
Δp= 10 bar	18	28	28	45	75	75
Δp= 30 bar	30	50	50	80	130	130
Max permissible flow	40	60	60	90	90	150
Δp max P-T [bar]	50	50	50	40	40	40
Response time (1) [ms]	≤ 18			≤ 25		
Leakage [cm³/min]	<500 (at p = 100 bar); <1500 (at p = 350 bar)			<800 (at p = 100 bar); <2500 (at p = 315 bar)		
Hysteresis	≤ 0,2 [% of max regulation]					
Repeatability	± 0,1 [% of max regulation]					
Thermal drift	zero point displacement < 1% at ΔT = 40°C					

(1) 0-100% step signal

5 ELECTRICAL CHARACTERISTICS

Max. power	35W
Insulation class	H (180°) Due to the occurring surface temperatures of the solenoid coils, the European standards ISO 13732-1 and EN982 must be taken into account
Protection degree with relevant cable gland	Multicertification: IP66/67 to DIN EN60529 UL: raintight enclosure, UL approved
Duty factor	Continuous rating (ED=100%)
Voltage code	standard
Coil resistance R at 20°C	3,2 Ω
Max. solenoid current	2,5 A

6 SEALS AND HYDRAULIC FLUID - for other fluids not included in below table, consult Atos Technical Office

Seals, recommended fluid temperature	NBR seals (standard) = -20°C ÷ +60°C, with HFC hydraulic fluids = -20°C ÷ +50°C FKM seals (/PE option) = -20°C ÷ +80°C HNBR seals (/BT option) = -40°C ÷ +60°C, with HFC hydraulic fluids = -40°C ÷ +50°C		
Recommended viscosity	20 ÷ 100 mm²/s - max allowed range 15 ÷ 380 mm²/s		
Max fluid contamination level	normal operation	ISO4406 class 18/16/13 NAS1638 class 7	see also filter section at
	longer life	ISO4406 class 16/14/11 NAS1638 class 5	www.atos.com or KTF catalog
Hydraulic fluid	Suitable seals type	Classification	Ref. Standard
Mineral oils	NBR, FKM, HNBR	HL, HLP, HLPD, HVLP, HVLPD	DIN 51524
Flame resistant without water	FKM	HFDU, HFDR	ISO 12922
Flame resistant with water (1)	NBR, HNBR	HFC	

⚠ The ignition temperature of the hydraulic fluid must be 50°C higher than the max solenoid surface temperature

(1) Performance limitations in case of flame resistant fluids with water:

- max operating pressure = 210 bar
- max fluid temperature = 50°C

7 CERTIFICATION DATA

Valve type	DHZA, DKZA		DHZA/M, DKZA/M	DHZA/UL, DKZA/UL	
Certifications	Multicertification Group II ATEX, IECEX, EAC, PESO, CCC		Multicertification Group I ATEX, IECEX	North American cULus	
Solenoid certified code	OZA-T		OZAM-T	OZA-T/EC	
Type examination certificate (1)	ATEX: CESI 02 ATEX 014 IECEX: IECEX CES 10.0010x EAC:RU C - IT.AX38.B.00425/21 PESO: P588812/3 CCC: 2024322307005903		ATEX: CESI 03 ATEX 057x IECEX: IECEX CES 12.0007x	20170324 - E366100	
Method of protection	<ul style="list-style-type: none"> • ATEX Ex II 2G Ex db IIC T4/T3 Gb Ex II 2D Ex tb IIIC T135°C/T200°C Db • IECEX Ex db IIC T4/T3 Gb Ex tb IIIC T135°C/T200°C Db • EAC 1Ex d IIC T4/T3 Gb X Ex tb IIIC T135°C/T200°C Db X • PESO Ex db IIC T4/T3 Gb • CCC Ex db IIC T4/T3 Gb Ex tb IIIC T135°C/T200°C Db 		<ul style="list-style-type: none"> • ATEX Ex I M2 Ex db I Mb • IECEX Ex db I Mb 	<ul style="list-style-type: none"> • UL 1203 Class I, Div.I, Groups C & D Class I, Zone I, Groups IIA & IIB 	
Temperature class	T4	T3	-	T4	T3
Surface temperature	≤ 135 °C	≤ 200 °C	≤ 150 °C	≤ 135 °C	≤ 200 °C
Ambient temperature (2)	-40 ÷ +40 °C	-40 ÷ +70 °C	-20 ÷ +60 °C	-40 ÷ +55 °C	-40 ÷ +70 °C
Applicable standards	EN 60079-0 EN 60079-1 EN 60079-31	IEC 60079-0 IEC 60079-1 IEC 60079-31	GB/T 3836.1 (only CCC) GB/T 3836.2 (only CCC) GB/T 3836.31 (only CCC)	UL 1203 and UL429, CSA 22.2 n°30 CSA 22.2 n°139	
Cable entrance: threaded connection	GK = GK-1/2" M = M20x1,5		NPT = 1/2" NPT	1/2" NPT	

(1) The type examination certificates can be downloaded from www.atos.com

(2) The solenoids **Group II** and **cULus** are certified for minimum ambient temperature -40°C

In case the complete valve must withstand with minimum ambient temperature of -40°C, select **/BT** in the model code

⚠ WARNING: service work performed on the valve by the end users or not qualified personnel invalidates the certification

8 EX PROOF SOLENOIDS WIRING

Multicertification

① solenoid cover with threaded connection for cable gland fitting
② transducer cover with threaded connection for cable gland fitting
③ solenoid terminal board for cables wiring
④ transducer terminal board for cables wiring
⑤ screw terminal for additional equipotential grounding

Solenoid wiring

	1 = Coil PCB 3 poles terminal board suitable for wires cross sections up to 2,5 mm ² (max AWG14)
2 = GND	
3 = Coil	

Position transducer wiring

	1 = Output signal PCB 4 poles terminal board suitable for wires cross sections up to 2,5 mm ² (max AWG14)
2 = Supply -15 V	
3 = Supply +15 V	
4 = GND	

cULus certification

① solenoid cover with threaded connection for cable gland fitting
② transducer cover with threaded connection for cable gland fitting
③ solenoid terminal board for cables wiring
④ transducer terminal board for cables wiring

Solenoid wiring **⚠ Pay attention to respect the polarity**

	1 = Coil + PCB 3 poles terminal board suggested cable section up to 1,5 mm ² (max AWG16), see section 9 note 1
2 = GND	
3 = Coil -	

alternative GND screw terminal connected to solenoid housing

Position transducer wiring

	1 = Output signal PCB 4 poles terminal board suggested cable section up to 1,5 mm ² (max AWG16), see section 9 note 1
2 = Supply -15 V	
3 = Supply +15 V	
4 = GND	

9 CABLE SPECIFICATION AND TEMPERATURE - Power supply and grounding cables have to comply with following characteristics:

Multicertification Group I and Group II	
Power supply: section of coil connection wires = 2,5 mm ²	Grounding: section of internal ground wire = 2,5 mm ² section of external ground wire = 4 mm ²
cULus certification:	
<ul style="list-style-type: none"> • Suitable for use in Class I Division 1, Gas Groups C • Armored Marine Shipboard Cable which meets UL 1309 • Tinned Stranded Copper Conductors • Bronze braided armor • Overall impervious sheath over the armor 	
Any Listed (UBVZ/UBVZ7) Marine Shipboard Cable rated 300 V min, 15A min. 3C 2,5 mm ² (14 AWG) having a suitable service temperature range of at least -25°C to +110°C ("BT" Models require a temperature range from -40°C to +110°C)	
Note 1: For Class I wiring the 3C 1,5 mm ² AWG 16 cable size is admitted only if a fuse lower than 10 A is connected to the load side of the solenoid wiring.	

9.1 Cable temperature

The cable must be suitable for the working temperature as specified in the "safety instructions" delivered with the first supply of the products.

Multicertification

Max ambient temperature [°C]	Temperature class		Max surface temperature [°C]		Min. cable temperature [°C]	
	Group I	Group II	Group I	Group II	Group I	Group II
40 °C	-	T4	150 °C	135 °C	-	90 °C
60 °C	-	-	150 °C	-	110 °C	-
70 °C	N.A.	T3	N.A.	200 °C	N.A.	120 °C

cULus certification

Max ambient temperature [°C]	Temperature class	Max surface temperature [°C]	Min. cable temperature
55 °C	T4	135 °C	100 °C
70 °C	T3	200 °C	100 °C

10 CABLE GLANDS - only **Multicertification**

Cable glands with threaded connections GK-1/2", 1/2"NPT or M20x1,5 for standard or armoured cables have to be ordered separately, see tech. table **KX800**

Note: a Loctite sealant type 545, should be used on the cable gland entry threads

11 OPTIONS

B = Solenoid and position transducer at side of port A of the main stage. For hydraulic configuration vs reference signal, see section **12**

C = Position trasducer with current feedback 4÷20 mA, suggested in case of long distance between the electric driver and the proportional valve

Y = External drain, to be selected if the pressure at T port is higher than the max allowed limits

11.1 Possible combined options: /BC, /BY, /CY, /BCY

12 DIAGRAMS - based on mineral oil ISO VG 46 at 50 °C

12.1 Regulation diagrams (values measure at Δp 30 bar P-T)

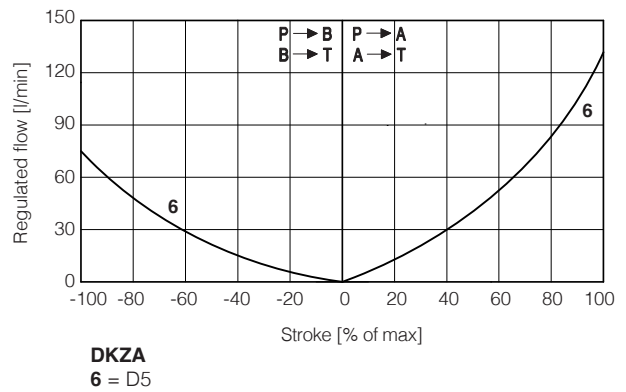
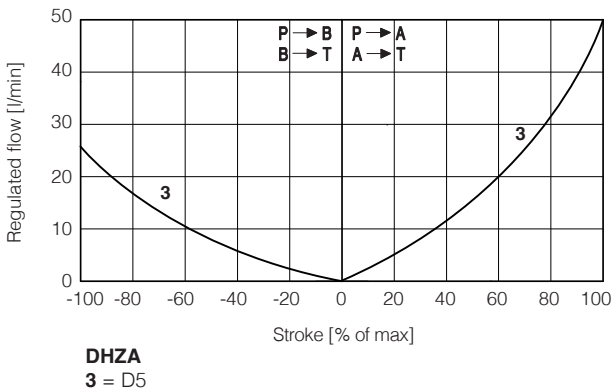
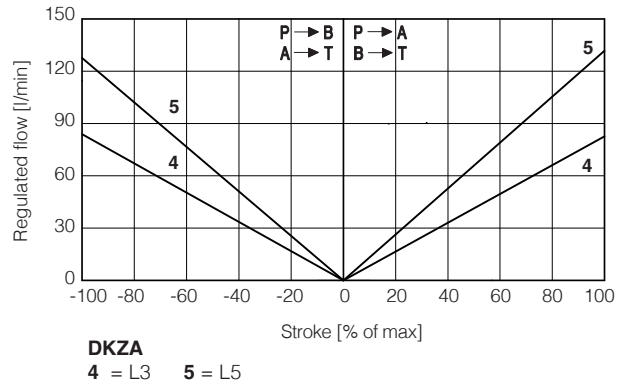
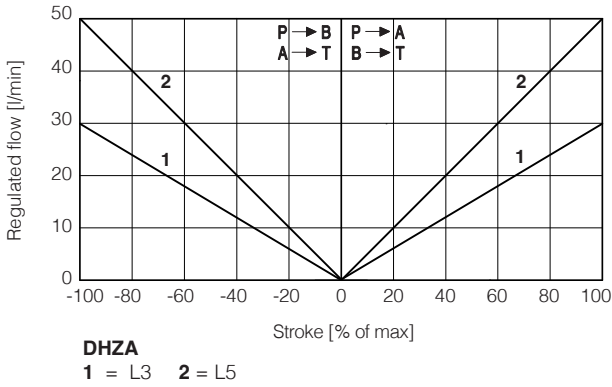

Note:

Hydraulic configuration vs. reference signal for configurations 70 (standard and option /B)

Reference signal $\left. \begin{matrix} 0 \div +10 \text{ V} \\ 12 \div 20 \text{ mA} \end{matrix} \right\} P \rightarrow A / B \rightarrow T$ Reference signal $\left. \begin{matrix} 0 \div -10 \text{ V} \\ 12 \div 4 \text{ mA} \end{matrix} \right\} P \rightarrow B / A \rightarrow T$

12.2 Spool safety rest position

In absence of electric power supply (+24 VDC), the valve spool is moved by the springs force to the **safety rest position** characterized by a small offset of about 1% to 6% of the total stroke in P-B / A-T configuration.

This is specifically designed to avoid that in case of accidental interruption of the electrical power supply to the valve, the actuator moves towards an undefined direction (due to the tolerances of the zero overlap spool), with potential risk of damages or personnel injury.

Thanks to the **safety rest position** the actuator movement is suddenly stopped and it is recovered at very low speed towards the direction corresponding to the P-B/ A-T connection.

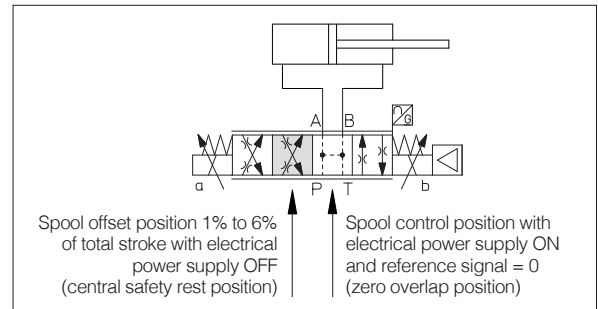

13 FASTENING BOLTS AND SEALS

	<p>DHZA</p> <p>Fastening bolts: 4 socket head screws M5x50 class 12.9 Tightening torque = 8 Nm</p>	<p>DKZA</p> <p>Fastening bolts: 4 socket head screws M6x40 class 12.9 Tightening torque = 15 Nm</p>
	<p>Seals: 4 OR 108; Diameter of ports P, A, B, T: Ø 7,5 mm (max) 1 OR 2025 Diameter of port Y: Ø = 3,2 mm (only for /Y option)</p>	<p>Seals: 5 OR 2050; Diameter of ports P, A, B, T: Ø 11,5 mm (max) 1 OR 108 Diameter of port Y: Ø = 5 mm (only for /Y option)</p>

14 INSTALLATION DIMENSIONS FOR DHZA [mm]

ISO 4401: 2005 (see table P005)
 Mounting surface: 4401-03-02-0-05
 (for /Y surface: 4401-03-03-0-05 without port X)

Mass [kg]	
DHZA-T-05	4,0
DHZA-T-07	5,1

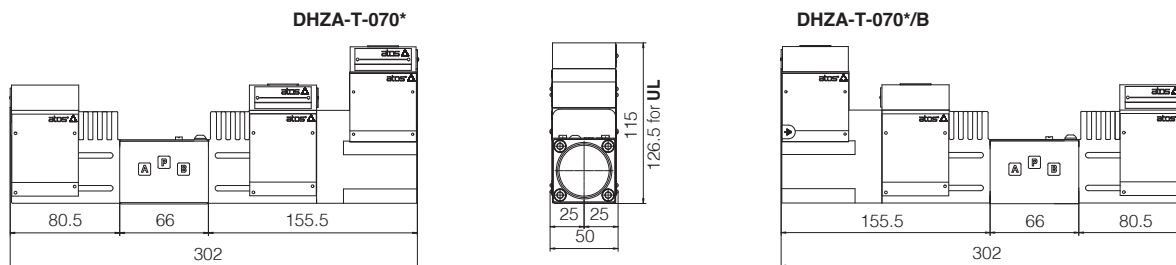

15 INSTALLATION DIMENSIONS FOR DKZA [mm]

ISO 4401: 2005 (see table P005)
 Mounting surface: 4401-05-04-0-05
 (for /Y surface: 4401-03-03-0-05 without port X)

Mass [kg]	
DKZA-T-17	7,8

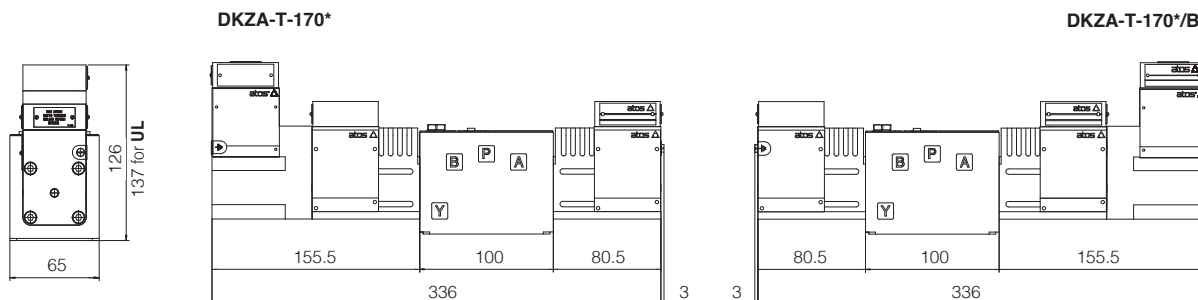

16 RELATED DOCUMENTATION

- X010** Basics for electrohydraulics in hazardous environments
- X020** Summary of Atos ex-proof components certified to ATEX, IECEx, EAC, CCC, PESO
- X030** Summary of Atos ex-proof components certified to cULus
- FX900** Operating and maintenance information for ex-proof proportional valves
- KX800** Cable glands for ex-proof valves
- P005** Mounting surfaces for electrohydraulic valves