

# Solenoid directional valves type DHL

direct, spool type, compact execution

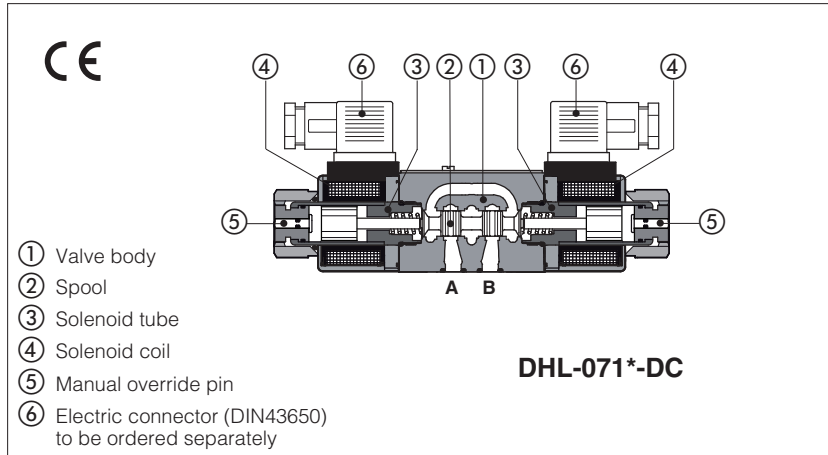

- ① Valve body
- ② Spool
- ③ Solenoid tube
- ④ Solenoid coil
- ⑤ Manual override pin
- ⑥ Electric connector (DIN43650) to be ordered separately

Spool type, 4/3, 4/2, 3/2 way version.

Wet type solenoids made by:

- screwed tube ③, different for AC and DC power supply
- interchangeable coils ④, specific for AC or DC power supply, easily replaceable without tools - see section ⑥ for available voltages

The valve body ① is 3 chamber type made by shell-moulding casting with wide internal passages ensuring low pressure drops.

Mounting surface: **ISO 4401 size 06**











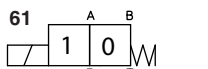
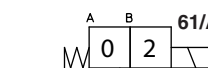
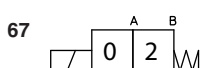
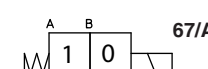
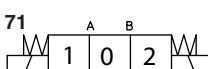
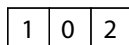
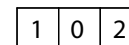
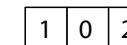
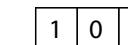
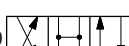
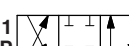

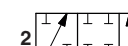
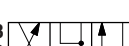

Max flow: **60 l/min**

Max pressure: **350 bar**

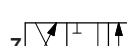
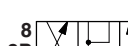
## 1 MODEL CODE

<b>DHL - 0</b>	<b>61</b>	<b>1</b>	<b>/ A -</b>	<b>X</b>	<b>24 DC</b>	<b>*</b>	<b>/ *</b>
Solenoid directional valves size 06					Voltage code, see section ⑥	Series number	Seals material, see section ⑭: - = NBR <b>PE</b> = FKM
Valve configuration, see section ②					<b>00-AC</b> = AC solenoids without coils <b>00-DC</b> = DC solenoids without coils <b>X</b> = without connector		
<b>61</b> = single solenoid, center plus external position, spring centered <b>63</b> = single solenoid, 2 external positions, spring offset <b>67</b> = single solenoid, center plus external position, spring offset <b>70</b> = double solenoid, 2 external positions, without springs <b>71</b> = double solenoid, 3 positions, spring centered <b>75</b> = double solenoid, 2 external positions, with detent					See section ⑫ for available connectors, to be ordered separately Coils with special connectors, see section ⑬		
Spool type, see section ②				Options, see section ⑦			

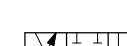
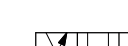
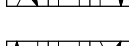
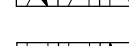
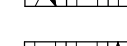
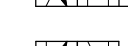
## 2 CONFIGURATIONS and SPOOLS (representation according to ISO 1219-1)

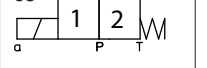
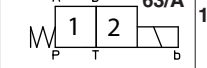
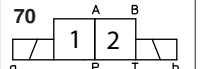
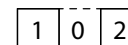
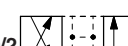
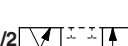
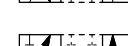
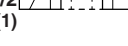
Configurations	Spools	Configurations	Spools
<b>61</b>  <b>61/A</b>  <b>67</b>  <b>67/A</b>  <b>71</b> 	    <b>0</b>  <b>1P</b>  <b>1/1</b>  <b>2</b>  <b>3</b>  <b>3P</b>  <b>4</b>  <b>4/8</b>  <b>5</b>  <b>6</b>  <b>7</b>  <b>8</b>  <b>8P</b>  <b>16</b>  <b>17</b>  <b>19</b>  <b>39</b>  <b>58</b>  <b>91</b>  <b>93</b>  <b>6/7</b> 	<b>63</b>  <b>63/A</b>  <b>70</b>  <b>75</b> 	 <b>0/2</b>  <b>1/2</b>  <b>1/2P</b>  <b>2/2</b>  <b>(1)</b> <b>(1)</b> not available for configuration 75

### Note:

Spool type **6/7** is available only for configuration 61, not available for version /A

Spools type **0** and **3** are also available as **0/1** and **3/1** with restricted oil passages in central position, from user ports to tank

Spools type **1, 4, 5** and **58** are also available as **1/1, 4/8, 5/1** and **58/1**. They are properly shaped to reduce water-hammer shocks during the switching

Spools type **1, 1/2, 3, 8** are available as **1P, 1/2P, 3P, 8P** to limit valve internal leakages.

### 3 GENERAL CHARACTERISTICS

Assembly position	Any position
Subplate surface finishing to ISO 4401	Acceptable roughness index, Ra ≤0,8 recommended Ra 0,4 - flatness ratio 0,01/100
MTTFd valves according to EN ISO 13849	150 years, see technical table P007
Ambient temperature range	<b>Standard</b> = -30°C ÷ +70°C <b>/PE</b> option = -20°C ÷ +70°C
Storage temperature range	<b>Standard</b> = -30°C ÷ +80°C <b>/PE</b> option = -20°C ÷ +80°C
Surface protection	Body: zinc coating with black passivation      Coil: zinc nickel coating (DC version) plastic incapsulation (AC version)
Corrosion resistance	Salt spray test (EN ISO 9227) > 200 h
Compliance	CE to Low Voltage Directive 2014/35/EU RoHS Directive 2011/65/EU as last update by 2015/863/EU REACH Regulation (EC) n°1907/2006

### 4 HYDRAULIC CHARACTERISTICS

Operating pressure	Ports P,A,B: <b>350</b> bar; Port T <b>210</b> bar for DC version; <b>160</b> bar for AC version
Max flow	<b>60 l/min</b> , see Q/Δp diagram at section 8 and operating limits at section 9

### 5 ELECTRICAL CHARACTERISTICS

Insulation class	<b>H</b> (180°C) for DC coils; <b>F</b> (155°C) for AC coils Due to the occurring surface temperatures of the solenoid coils, the European standards EN ISO 13732-1 and EN ISO 4413 must be taken into account
Protection degree to DIN EN 60529	<b>IP 65</b> (with connectors 666, 667 correctly assembled)
Relative duty factor	100%
Supply voltage and frequency	See section 6
Supply voltage tolerance	± 10%

### 6 COIL VOLTAGE

External supply nominal voltage ± 10%	Voltage code	Type of connector	Power consumption (2)	Code of spare coil DHL
12 DC	<b>12 DC</b>	666 or 667	29W	COL-12DC
14 DC	<b>14 DC</b>			COL-14DC
24 DC	<b>24 DC</b>			COL-24DC
28 DC	<b>28 DC</b>			COL-28DC
110 DC	<b>110 DC</b>			COL-110DC
220 DC	<b>220 DC</b>			COL-220DC
110/50 AC (1)	<b>110/50/60 AC</b>	669	58VA (3)	COL-110/50/60AC
115/60 AC	<b>115/60 AC</b>			COL-115/60AC
230/50 AC (1)	<b>230/50/60 AC</b>			COL-230/50/60AC
230/60 AC	<b>230/60 AC</b>			COL-230/60AC
110/50 AC - 120/60 AC	<b>110 DC</b>	669	29W	COL-110DC
230/50 AC - 230/60 AC	<b>220 DC</b>			COL-220DC

(1) Coil can be supplied also with 60 Hz of voltage frequency: in this case the performances are reduced by 10÷15% and the power consumption is 55 VA.

(2) Average values based on tests preformed at nominal hydraulic condition and ambient/coil temperature of 20°C.

(3) When solenoid is energized, the inrush current is approx 3 times the holding current. Inrush current values correspond to a power consumption of about 150 VA.

### 7 OPTIONS

**A** = Solenoid mounted at side of port B (only for single solenoid valves). In standard versions, solenoid is mounted at side of port A.

**MV, MO** = auxiliary hand lever positioned vertically (MV) or horizontally (MO). For available configuration and dimensions see section 18

**WP** = prolonged manual override protected by rubber cap.

Available for configuration: **61 - 63 - 71**, spools: **0 - 0/2 - 1 - 1P - 1/2 - 1/2P - 3 - 3P - 4 - 7**

#### 7.1 Accessories

**WPD/HL** = (only for DHL-**DC**) manual override with detent, to be ordered separately, see section 18

⚠ The manual override operation can be possible only if the pressure at T port is lower than 50 bar

**8 Q/ΔP DIAGRAMS** based on mineral oil ISO VG 46 at 50°C

Spool type	Flow direction				
	P→A	P→B	A→T	B→T	P→T
0	A	A	C	C	D
1, 1P, 1/1	C	C	C		
3, 3P, 3/1	D	D	A	A	
4, 4/8, 5	F	F	G	C	E
0/2, 1/2, 1/2P	D	D	D	D	
6, 7, 16, 17	D	D	D	D	
8, 8P	A	A	E	E	
2, 6/7	D	D			
2/2	F	F			
19, 91	E	E	D	D	
39, 93	F	F	G	G	

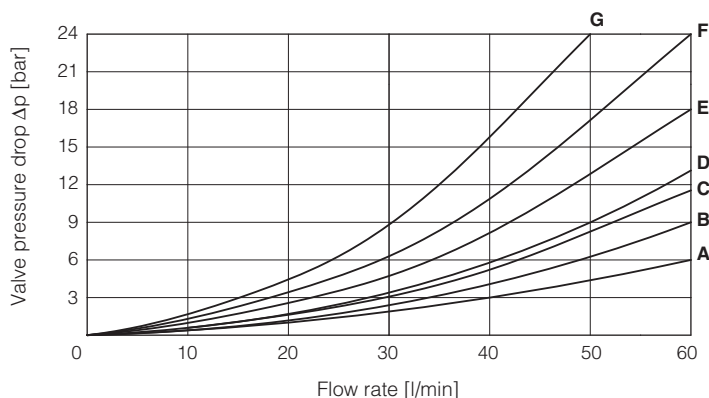

**9 OPERATING LIMITS** based on mineral oil ISO VG 46 at 50°C

The diagrams have been obtained with warm solenoids and power supply at lowest value ( $V_{nom} - 10\%$ ). The curves refer to application with symmetrical flow through the valve (i.e. P→A and B→T). In case of asymmetric flow and if the valves have the devices for controlling the switching times the operating limits must be reduced.

Curve	DC version, spool type:
A	0, 0/2, 1/2, 1/2P, 8, 8P
B	1, 1P, 1/1
C	3, 3P, 3/1, 6, 7
D	4, 4/8, 16, 17, 5, 19, 39, 58, 91, 93
E	2, 2/2, 6/7

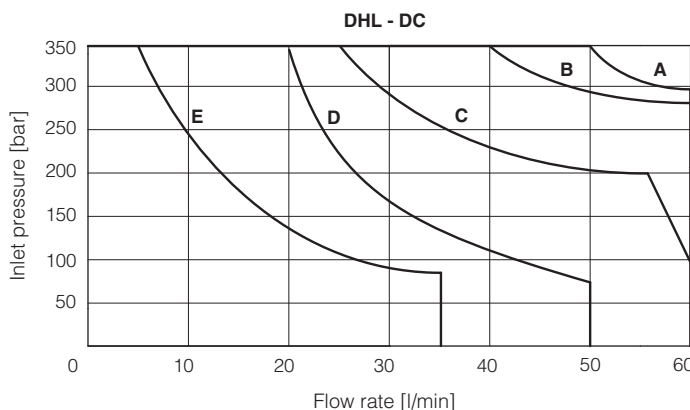

Curve	AC version, spool type:
A	0, 0/2, 1/2, 1/2P, 8, 8P
B	1, 1P, 1/1
C	3, 3P, 3/1, 6, 7
D	4, 16, 17, 4/8, 5, 19, 39, 58, 91, 93
E	2, 2/2, 6/7

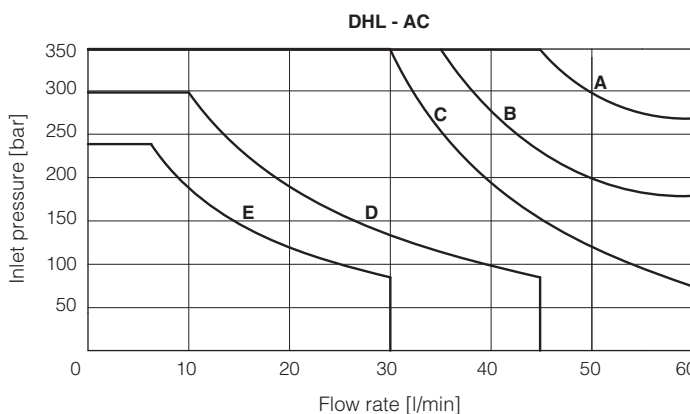

**10 SWITCHING TIMES** (average values in msec)

- Test conditions: - 20 l/min; 150 bar
- nominal voltage
- 2 bar of counter pressure on port T
- mineral oil: ISO VG 46 at 50°C

The elasticity of the hydraulic circuit and the variations of the hydraulic characteristics and temperature affect the response time.

Valve	Switch-on AC	Switch-off AC	Switch-on DC	Switch-off DC
DHL	10 - 25	20 - 40	30 - 50	15 - 25

**11 SWITCHING FREQUENCY**

Valve	AC (cycles/h)	DC (cycles/h)
DHL + 666 / 667	7200	15000

**12 ELECTRIC CONNECTORS ACCORDING TO DIN 43650** (to be ordered separately, see tech table K500)

**666** = standard connector IP-65, suitable for direct connection to electric supply source

**667** = as 666, but with built-in signal led. Available for power supply voltage 24 AC or DC, 110 AC or DC, 220 AC or DC

**669** = with built-in rectifier bridge for supplying DC coils by alternate current (AC 110V and 230V - I<sub>max</sub> 1A)

**E-SD** = electronic connector which eliminates electric disturbances when solenoid valves are de-energized

**13 COILS WITH SPECIAL CONNECTORS** only for voltage supply **12, 14, 24, 28 Vdc**

**Deutsch connector DT-04-2P**

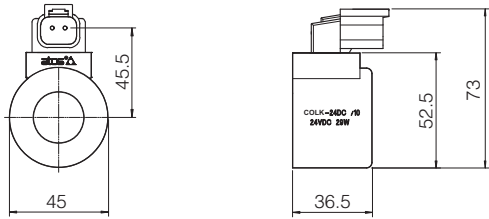

**Options -XK**

Coil type COLK, Deutsch connector DT-04-2P male  
Protection degree **IP67**

Note: For the electric characteristics refer to standard coils features - see section 6

**14 SEALS AND HYDRAULIC FLUID** - for other fluids not included in below table, consult our technical office

Seals, recommended fluid temperature	NBR seals (standard) = -20°C ÷ +80°C, with HFC hydraulic fluids = -20°C ÷ +50°C FKM seals (/PE option) = -20°C ÷ +80°C		
Recommended viscosity	15 ÷ 100 mm <sup>2</sup> /s - max allowed range 2,8 ÷ 500 mm <sup>2</sup> /s		
Max fluid contamination level	ISO4406 class 20/18/15 NAS1638 class 9, see also filter section at <a href="http://www.atos.com">www.atos.com</a> or KTF catalog		
<b>Hydraulic fluid</b>	<b>Suitable seals type</b>	<b>Classification</b>	<b>Ref. Standard</b>
Mineral oils	NBR, FKM	HL, HLP, HLPD, HVLP, HVLPD	DIN 51524
Flame resistant without water	FKM	HFDU, HFDR	ISO 12922
Flame resistant with water	NBR	HFC	

**15 PLUG-IN RESTRICTOR** (to be ordered separately)

The use of plug-in restrictors in valve's ports P or A or B may be necessary in case of particular conditions as long flexible hoses or the presence of accumulators which could cause at the valve switching instantaneous high flow peaks over the max valve's operating limits.

<b>PLUG-H</b>	-	<b>**</b>	<b>A</b>
<p><b>08, 10, 12, 15</b> calibrated orifice diameter in tenths of mm                  Example PLUG-H-12 = orifice diameter <b>1,2 mm</b>                  Other orifice dimensions are available on request</p>			
Short calibrated orifice			

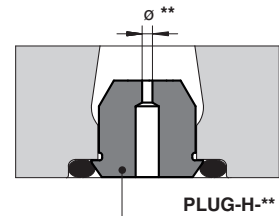

**16 FASTENING BOLTS AND SEALS**

<b>Fastening bolts</b>	<b>Seals</b>
4 socket head screws M5x30 class 12.9 Tightening torque = 8 Nm	4 OR 108; Diameter of ports A, B, P, T: Ø 7,5 mm (max)

17 DIMENSIONS [mm]

ISO 4401: 2005

Mounting surface: 4401-03-02-0-05

Mass (Kg)		
	DC	AC
DHL-06	1,3	1,2
DHL-07	1,6	1,4

**P** = PRESSURE PORT  
**A, B** = USE PORT  
**T** = TANK PORT

Valve's bottom view

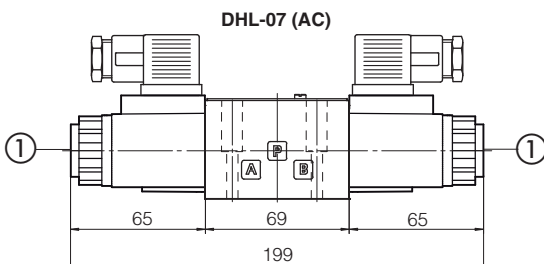
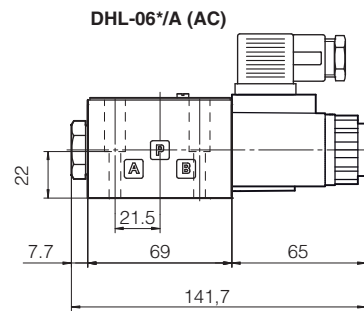
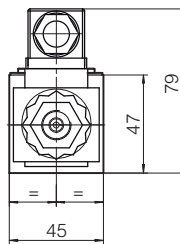
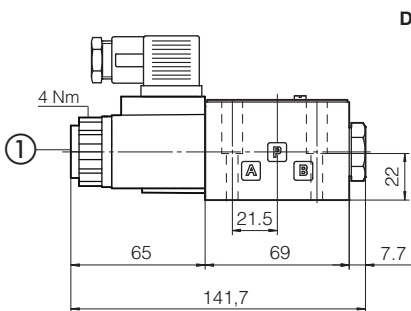
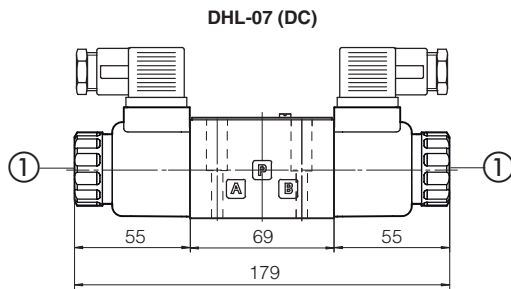
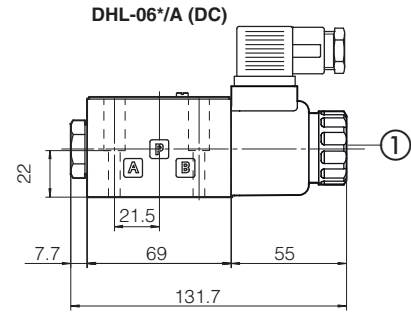
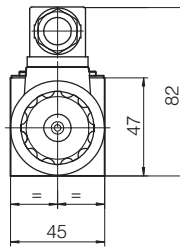
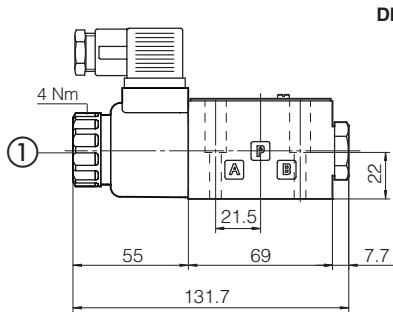
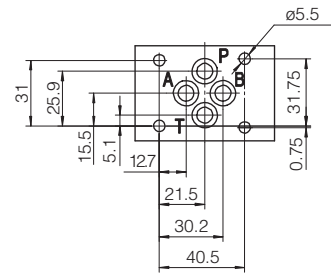

① Standard manual override PIN

⚠ The manual override operation can be possible only if the pressure at T ports is lower than 50 bar

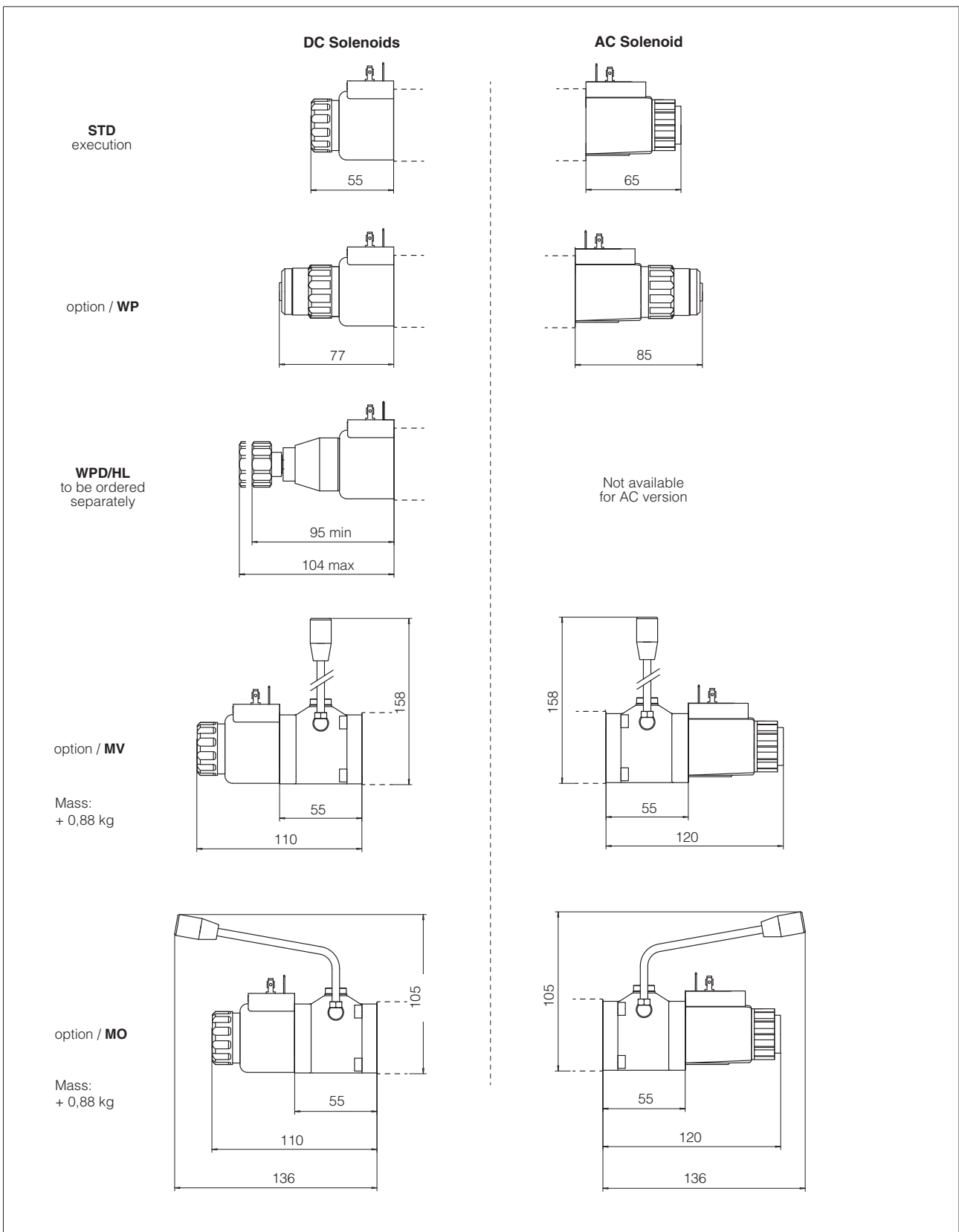

19 RELATED DOCUMENTATION

<b>E001</b>	Basics for solenoid directional valves	<b>P005</b>	Mounting surfaces for electrohydraulic valves
<b>K150</b>	Handweels for hydraulic controls	<b>E900</b>	Operating and maintenance information
<b>K280</b>	Single and modular subplates		
<b>K800</b>	Electric and electronic connectors		