

Hydraulic operated directional valves type SDP

ISO 4401 size 16, 25 and 32

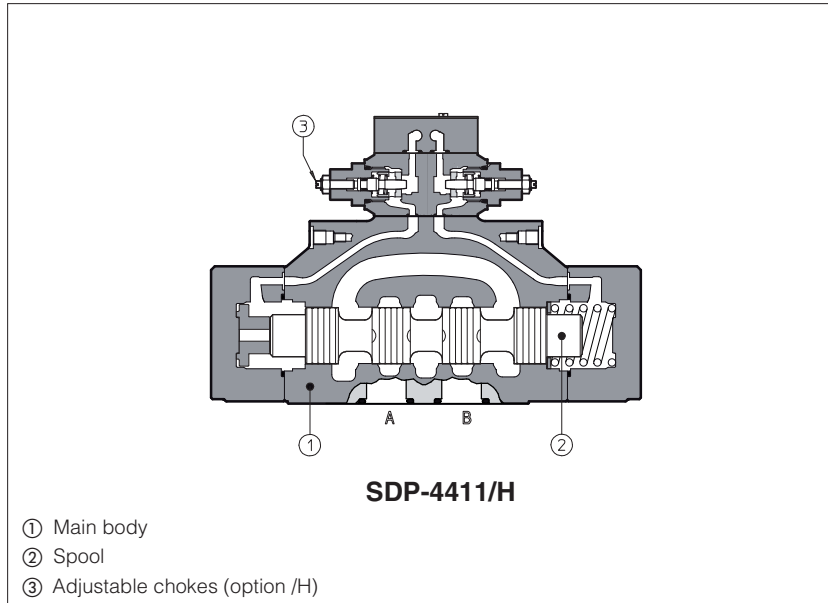

Spool type hydraulic operated directional valves in three or four way, two or three position, designed to operate in oil hydraulic systems.
Available with single or double hydraulic actuator.

Mounting surface: **ISO 4401**
size 16, 25, 32











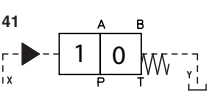
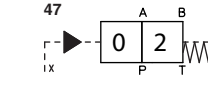
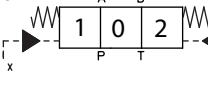
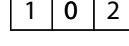
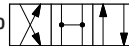

SDP-2 = size 16, flow up to 300 l/min
SDP-4 = size 25, flow up to 700 l/min
SDP-6 = size 32, flow up to 1000 l/min

Max pressure: **350 bar**

1 MODEL CODE

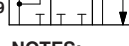
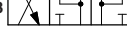
SDP-2	4	1	3	/	H	**	/	*
Hydraulic operated directional control valve, size: SDP-2 = 16 SDP-4 = 25 SDP-6 = 32						Series number		Seals material, see section 4: - = NBR PE = FKM BT = HNBR
Type of actuator: 4 = single actuator 5 = double actuator						Options: /H = adjustable chokes for controlling the main spool shifting time (meter-out to the pilot chambers of the main valve) /R = pilot pressure generator (4 bar on port P) /S = main spool stroke adjustment		
Valve configuration, see section 2 : 0 = free, without springs 1 = spring centered, without detent 3 = spring offset external position 7 = center and external positions						Spool type, see section 2		

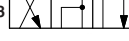
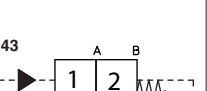
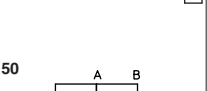
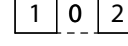
2 CONFIGURATIONS and SPOOLS valves type SDP-*

Configurations	Spools	Configurations	Spools
<p>41 </p> <p>47 </p> <p>51 </p>	<p>1 0 2 </p> <p>0  1  2  3 </p> <p>4  5  6  7 </p> <p>91  19  93  39 </p> <p>58 </p>	<p>43 </p> <p>50 </p>	<p>0/2 </p> <p>1/2 </p> <p>2/2 </p>
<p>NOTES: - For DP*-6 are available only spools: 0, 1, 1/2, 2, 3, 4, 5, 58, 6, 7, 19, 91</p>			

Special shaped spools

- spools type **0** and **3** are also available as **0/1** and **3/1** with restricted oil passages in central position, from user ports to tank.
- spools type **1** and **4** are also available as **1/1** and **4/8** are properly shaped to reduce water-hammer shocks during the switching.

3 HYDRAULIC CHARACTERISTICS

Valve model		SDP-2	SDP-4	SDP-6
Max recommended flow	[l/min]	300	700	1000
Max pressure on port P, A, B	[bar]	350		
Max pressure on port T (also X, Y for SDP)	[bar]	250		
Minimum pilot pressure	[bar]	4		
Max recommended pressure on piloting line	[bar]	250		

(1) The max pressure on port T has to be not over 50% of pilot pressure

4 MAIN CHARACTERISTICS, SEALS AND FLUIDS - for other fluids not included in below table, consult our technical office

Assembly position / location	any position except for valves type SDP-*50 (without springs) that must be installed with their longitudinal axis horizontal		
Subplate surface finishing	roughness index Ra 0,4 - flatness ratio 0,01/100 (ISO 1101)		
MTTFd values according to EN ISO 13849	150 years, for further details see technical table P007		
Ambient temperature range	standard execution = -30°C ÷ +70°C; /PE option = -20°C ÷ +70°C; /BT option = -40°C ÷ +70°C		
Seals, recommended fluid temperature	NBR seals (standard) = -20°C ÷ +80°C, with HFC hydraulic fluids = -20°C ÷ +50°C FKM seals (/PE option) = -20°C ÷ +80°C HNBR seals (/BT option) = -40°C ÷ +60°C, with HFC hydraulic fluids = -40°C ÷ +50°C		
Recommended viscosity	15 ÷ 100 mm ² /s - max allowed range 2,8 ÷ 500 mm ² /s		
Max fluid contamination level	ISO4406 class 20/18/15 NAS1638 class 9, see also filter section at www.atos.com or KTF catalog		
Hydraulic fluid	Suitable seals type	Classification	Ref. Standard
Mineral oils	NBR, FKM, HNBR	HL, HLP, HLPD, HVLP, HVLPD	DIN 51524
Flame resistant without water	FKM	HFDU, HFDR	ISO 12922
Flame resistant with water	NBR, HNBR	HFC	

5 Q/ΔP DIAGRAMS

SDP-2	See note and diagrams on table SHE085 relating the SDPH*-2 valve from which SDP-2* are derivated
SDP-4	See note and diagrams on table SHE085 relating the SDPH*-4 valve from which SDP-4* are derivated
SDP-6	See note and diagrams on table SHE085 relating the SDPH*-6 valve from which SDP-6* are derivated

6 PILOT PRESSURE GENERATOR (option /R)

The device /R generates an additional pressure drop, in order to ensure the minimum pilot pressure, for correct operation of the valves with internal pilot and fitted with spools type **0, 0/1, 4, 4/8, 5, 589**. The device /R has to be fitted when the pressure drop in the valve, verified on flow versus pressure diagrams, is lower than the minimum pilot pressure value.

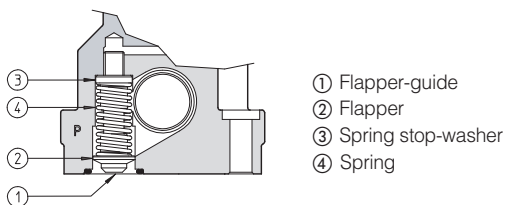

7 DIMENSIONS OF HYDRAULIC OPERATED VALVES ISO 4401 size 16, 25 and 32 [mm]

SDP-2

ISO 4401: 2005

Mounting surface: 4401-07-07-0-05

Fastening bolts:

4 socket head screws M10x50 class 12.9

Tightening torque = 70 Nm

2 socket head screws M6x45 class 12.9

Tightening torque = 15 Nm

Diameter of ports A, B, P, T: $\varnothing = 20$

Diameter of ports X, Y: $\varnothing = 7$ mm

Diameter of port L: $\varnothing = 5$ mm

Seals: 4 OR 130, 2 OR 2043

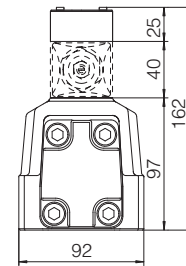
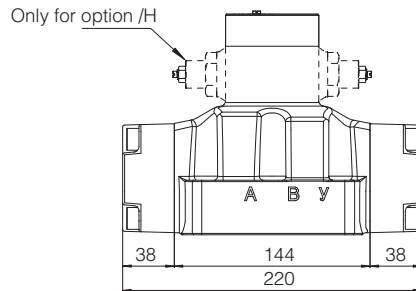
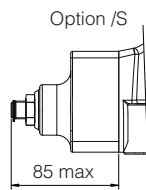
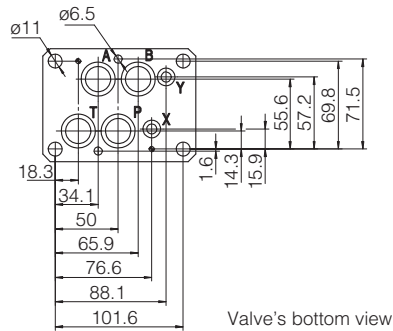

Mass: 10 Kg

SDP-4

ISO 4401: 2005

Mounting surface: 4401-08-08-0-05

Fastening bolts:

6 socket head screws M12x60 class 12.9

Tightening torque = 125 Nm

Diameter of ports A, B, P, T: $\varnothing = 24$

Diameter of ports X, Y: $\varnothing = 7$ mm

Diameter of port L: $\varnothing = 5$ mm

Seals: 4 OR 4112, 2 OR 3056

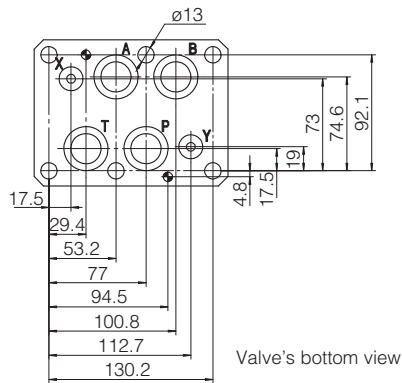

P = PRESSURE PORT
A, B = USE PORT
T = TANK PORT
X = EXTERNAL OIL PILOT PORT
Y = DRAIN PORT

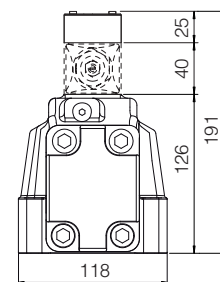
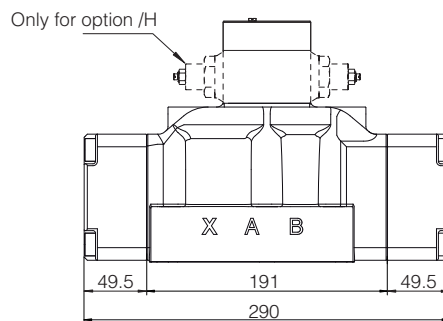
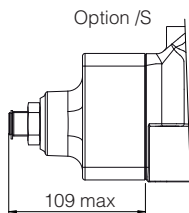

Mass: 16,5 Kg

SDP-6

ISO 4401: 2005

**Mounting surface: 4401-10-09-0-05
(port L optional)**

Fastening bolts:

6 socket head screws M20x80 class 12.9

Tightening torque = 600 Nm

Diameter of ports A, B, P, T : $\varnothing = 34$ mm

Diameter of ports X, Y: $\varnothing = 7$ mm

Diameter of port L: $\varnothing = 5$ mm

Seals: 4 OR 144, 2 OR 3056

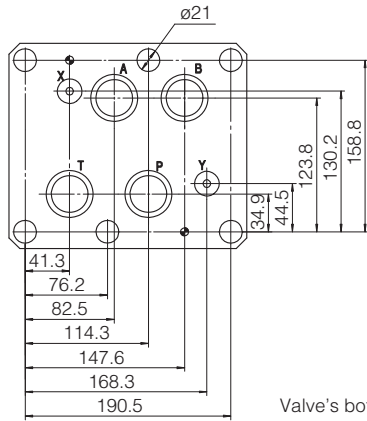

Valve's bottom view

- P** = PRESSURE PORT
- A, B** = USE PORT
- T** = TANK PORT
- X** = EXTERNAL OIL PILOT PORT
- Y** = DRAIN PORT

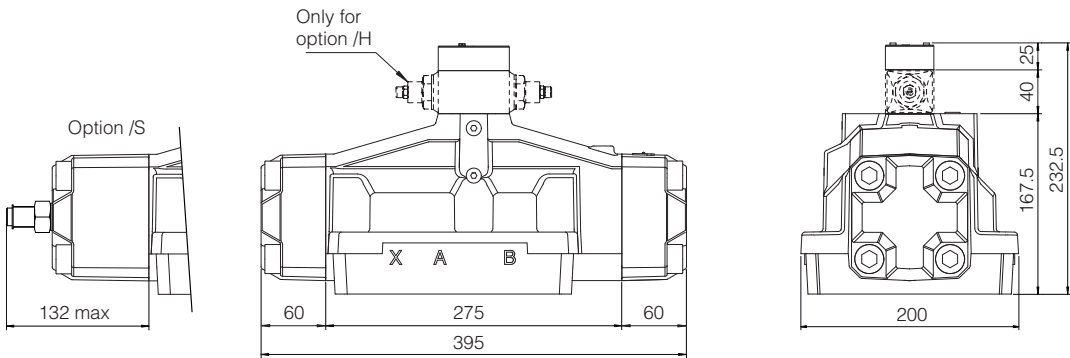

Mass: 38 Kg