

# Operating and maintenance information

for ex-proof on-off valves

This operating and maintenance information applies to Atos ex-proof on-off valves and is intended to provide useful guidelines to avoid risks when the valves are installed in a system operating in hazardous areas with explosive or flammable environment.

The prescriptions included in this document must be strictly observed to avoid damages and injury. The respect of this operating and maintenance information grant an increased working life, trouble-free operation and thus reduced repairing costs.

Information and notes on the transport and storage of the valves are also provided.

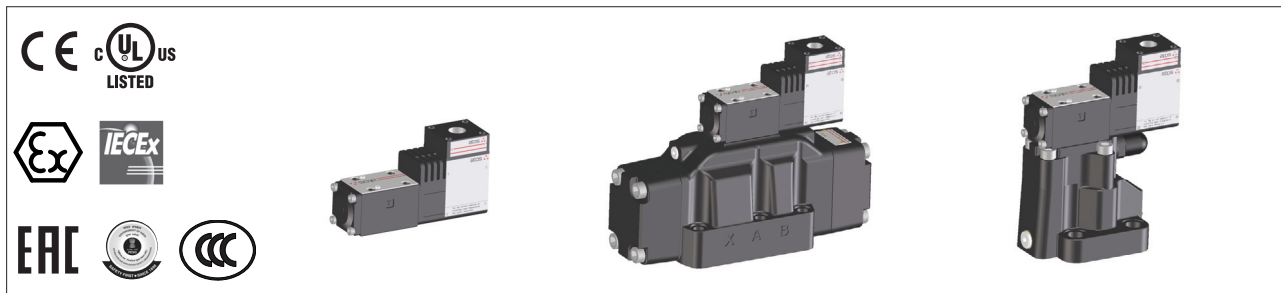

## 1 SYMBOL CONVENTIONS



This symbol refers to possible danger which can cause serious injuries

## 2 GENERAL NOTES

The operating and maintenance information is part of the operating instructions for the complete machine but it cannot replace them.

This document is relevant to the installation, use and maintenance of on-off directional, flow and pressure control valves equipped with ex-proof solenoids type OA-\* for application in explosive hazardous environments.

### 2.1 Warranty

All the ex-proof on-off valves have 1 year warranty; the expiration of warranty results from the following operations:

- unauthorized mechanical or electronic interventions
- the ex-proof on-off valves are not used exclusively for their intended purpose as defined in these operating and maintenance instructions



**Service work performed on the valve by the end users or not qualified personnel invalidates the certification**

## 3 CERTIFICATIONS

### 3.1 Ex-proof certification and protection mode

The ex-proof on-off solenoids subject of this operating and maintenance information are multicertified ATEX, IECEx, EAC, CCC or cULus. They are in compliance with following protection mode:

Multicertification Group II – ATEX, IECEx, EAC, PESO, CCC

II 2 G Ex d IIC T6, T4, T3 Gb

II 2 D Ex tb IIIC T85°C, T135°C, T200°C Db

MA chinese mining certification

db I Mb

Multicertification Group I (mining) – ATEX, IECEx

I M2 Ex d I Mb

cULus Noth American certification

**Class I, Div. I, Groups C & D T. class T4/T3**

**Class I, Zone I, Groups II A & II B T. class T4/T3**

### 3.2 SIL certification in accordance with IEC 61508

Valves DHA, DLAH, DLAHM are TUV certified in compliance with IEC EN 61508:2010 as being suitable for use in safety-related application up to SIL 3. This manual covers all installation, maintenance and operation requirements for these applications.

## 4 HARMONIZED STANDARDS

The Essential Health and Safety Requirements are assured by compliance to the following standards:

### ATEX

- EN 60079-0 Explosive atmospheres - Equipment: General requirements
- EN 60079-1 Explosive atmospheres - Equipment protection by flameproof enclosures "d"
- EN 60079-31 Explosive atmospheres - Equipment dust ignition protection by enclosures "t"

### IECEx

- IEC 60079-0 Explosive atmospheres - Part 0: General requirements
- IEC 60079-1 Explosive atmospheres - Part 1: Equipment protection by flameproof enclosures "d"
- IEC 60079-31 Explosive atmospheres - Part 31: Equipment dust ignition protection by enclosures "t"

### cULus

- UL 1203 Standard for Explosion-Proof and Dust-Ignition-Proof Electrical Equipment for use in Hazardous (classified) locations
- UL 429 Standard for Electrically Operated valves
- CSA C22.2 No.139-13 Electrically Operated Valves

### CCC

- GB/T 3836.1, GB/T 3836.2, GB/T 3836.31

## 5 GENERAL CHARACTERISTICS

|                           |  |
|---------------------------|--|
| Ambient temperature range | <b>Standard</b> = -20°C ÷ +60°C <b>/PE option</b> = -20°C ÷ +60°C <b>/BT option</b> = -40°C ÷ +60°C  |
| Storage temperature range | <b>Standard</b> = -20°C ÷ +70°C <b>/PE option</b> = -20°C ÷ +70°C <b>/BT option</b> = -40°C ÷ +70°C  |
| Surface protection        | Zinc coating with black passivation - salt spray test (EN ISO 9227) > 200 h  |
| Compliance                | Explosion proof protection<br>-Flame proof enclosure "Ex d"<br>-Dust ignition protection by enclosure "Ex t"<br><br>RoHs Directive 2011/65/EU as last update by 2015/863/EU<br>REACH Regulation (EC) n°1907/2006 |

## 6 HYDRAULIC CHARACTERISTICS

See technical tables relevant to the specific components, listed in section 12

## 7 ELECTRIC CHARACTERISTICS

|                           |                           |              |
|---------------------------|---------------------------|--------------|
| Harmonized standard       | <b>Multicertification</b> | <b>cULus</b> |
| Power consumption at 20°C | 8W                        | 12W          |

See technical tables relevant to the specific components, listed in section 12

## 8 NAMEPLATES

### 8.1 ATEX and IECEx multicertification

#### Gas - group I M2 - Mining

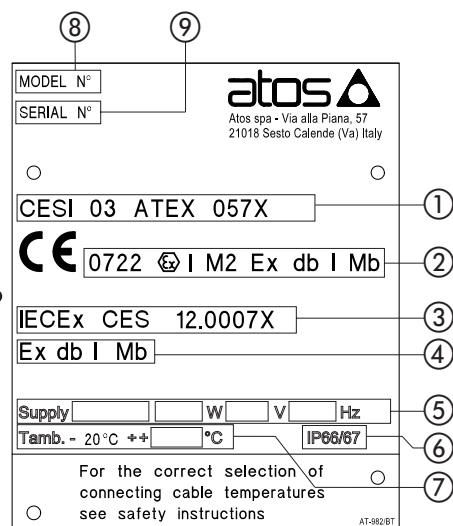
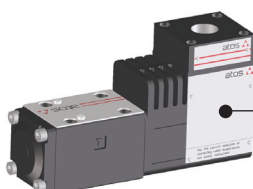

- ① ATEX notified body and certificate number
- ② Marking according to ATEX Directive
- ③ IECEx notified body and certificate number
- ④ Marking according to IECEx Scheme
- ⑤ Power supply characteristics
- ⑥ Ingress protection:
  - IP66 = no dust ingress, protection against heaving seas or powerful jets of water
  - IP67 = no dust ingress, protection to water immersion
- ⑦ Ambient temperature
- ⑧ Solenoid model code
- ⑨ Solenoid serial number

|                           |  |
|---------------------------|--|
|                           | Mark of conformity to the applicable European directives   |
|                           | Mark of conformity to the 2014/34/UE directive and to the relevant technical norms   |
| <b>I M2</b>               | Equipment for mining (or relevant surface plants) which could be exposed to gas and / or flammable dust. The power supply of these equipment have to be switched off in case of explosive atmosphere.                            |
| <b>Ex db</b>              | Explosion-proof equipment  |
| <b>I</b>                  | Group I equipment suitable for substances (gas) for group I  |
| <b>Mb</b>                 | Equipment protection level, high level protection for explosive atmospheres  |
| <b>CESI 03 ATEX 057 X</b> | Name of the laboratory responsible for the CE certification:<br>03 year of the certification release; 057 certification number<br>X= reduced risk of mechanical shock (the equipment has to be protected from mechanical shocks) |
| <b>0722</b>               | Number of the Certified Body authorized for the production quality system certification: 0722 = CESI   |
| <b>IECEX CES 12.007X</b>  | Certificate number: CES laboratory name responsible for the IEC Ex certification scheme:<br>12 year of the certification release; 007X number of certification   |
| <b>T amb.</b>             | Ambient temperature range  |

## 8.2 ATEX, IECEx, EAC, CCC and PESO multicertification

Gas - group II 2G - Zone 1, 2  
Dust - group II 2D - Zone 21, 22



- ① ATEX notified body and certificate number
- ② Marking according to ATEX Directive
- ③ IECEx notified body and certificate number
- ④ Marking according to IECEx Scheme
- ⑤ EAC notified body and certificate number
- ⑥ Marking according to EAC
- ⑦ PESO certificate number
- ⑧ Power supply characteristics
- ⑨ Ingress protection:
  - IP66 = no dust ingress, protection against heaving seas or powerful jets of water
  - IP67 = no dust ingress, protection to water immersion
- ⑩ Ambient temperature
- ⑪ Solenoid model code
- ⑫ Solenoid serial number
- ⑬ Marking according to CCC certification

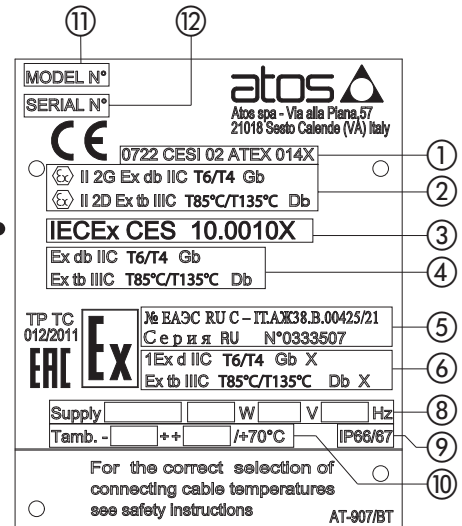
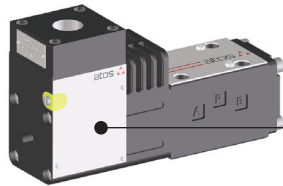

|                               |   |
|-------------------------------|---|
|                               | Mark of conformity to the applicable European directives  |
|                               | Mark of conformity to the 2014/34/UE directive and to the relevant technical norms  |
| <b>II 2 G</b>                 | Equipment for surface plants with gas or vapors environment, category 2, suitable for zone 1 and 2  |
| <b>Ex db</b>                  | Explosion-proof equipment   |
| <b>II C</b>                   | Group II C equipment suitable for substances (gas) for group II C   |
| <b>T6, T4, T3</b>             | Equipment temperature class (maximum surface temperature)   |
| <b>Gb</b>                     | Equipment protection level, high level protection for explosive Gas atmospheres   |
| <b>II 2 D</b>                 | Equipment for surface plants with dust environment, category 2, suitable for zone 21 and zone 22  |
| <b>Ex tb</b>                  | Equipment protection by enclosure "tb"  |
| <b>IIIC</b>                   | Suitable for conductive dust (applicable also IIIB and/or IIIA)   |
| <b>T85°C, T135°C, T200°C,</b> | Maximum surface temperature (Dust)  |
| <b>Db</b>                     | Equipment protection level, high level protection for explosive Dust atmospheres  |
| <b>CESI 02 ATEX 014 X</b>     | Name of the laboratory responsible for the CE certification:<br>02 year of the certification release; 014 X certification number                                |
| <b>0722</b>                   | Number of the Certified Body authorized for the production quality system certification: 0722 = CESI  |
| <b>IECEx CES 10.0010X</b>     | Certificate number: CES laboratory name responsible for the IEC Ex certification scheme:<br>10 year of the certification release; 0010X number of certification |
| <b>T amb.</b>                 | Ambient temperature range   |
| <b>IP66/67</b>                | Protection degree   |

### 8.3 cULus certification

**Class I, Division 1**  
**Class I, Zone 1**

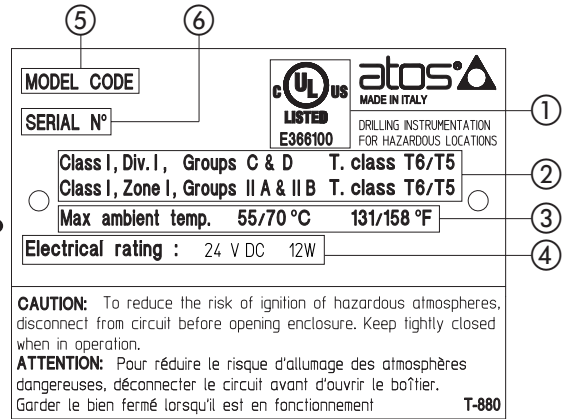

- ① cULus marking and certificate number
- ② Marking according to NEC 500 and NEC 505 standards
- ③ Ambient temperature
- ④ Power supply characteristics
- ⑤ Solenoid model code
- ⑥ Solenoid serial number

|                             |   |
|-----------------------------|---|
|                             | cULus mark and certificate number   |
| <b>Class I</b>              | Equipment for flammable gas and vapours   |
| <b>Division I</b>           | Explosive substances continuously or intermittently present in the atmosphere               |
| <b>Groups C &amp; D</b>     | Gas group C (Methane, Buthane, Petrol, etc) and D (Etylene, Formaldeyde, Clorupropane, etc) |
| <b>Zone I</b>               | Location where explosive substances are continuously present                                |
| <b>Groups IIA &amp; IIB</b> | Equipment of group IIA and IIB suitable for gas of group IIA and IIB                        |
| <b>Class T6/T5</b>          | Solenoid temperature class (maximum surface temperature)                                    |
| <b>Max ambient temp.</b>    | Max ambient temperature range in °C and °F  |

### 8.4 MA certification

**Gas - group I Mb - Mining**

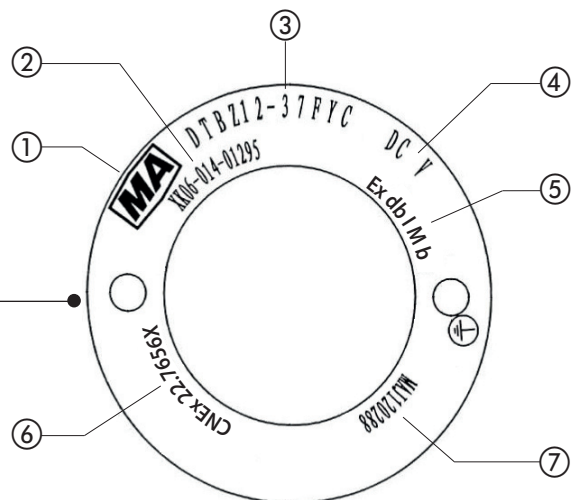
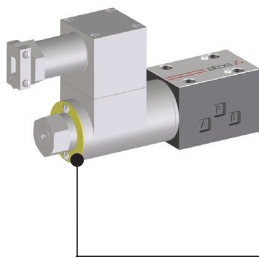

- ① MA logo
- ② License
- ③ Solenoid model code
- ④ Power supply characteristics
- ⑤ MA classification for Mining
- ⑥ MA certificate number
- ⑦ Notified body and certificate number

|              |   |
|--------------|---|
|              | MA certification mark   |
| <b>Ex db</b> | Explosion-proof equipment   |
| <b>I</b>     | Group I equipment suitable for substances (gas) for group I                 |
| <b>Mb</b>    | Equipment protection level, high level protection for explosive atmospheres |

## 9 SAFETY NOTES

### 9.1 Improper use

Any improper use of the components is not admissible.

Improper use of the product includes:

- Wrong installation / installation in areas not approved for the specific component
- Incorrect cleanliness during storage and assembly
- Use of inappropriate or non-admissible hydraulic fluids
- Use outside of specified performance limits
- Use of inappropriate electrical power supply
- Incorrect transport

### 9.2 Installation



The installation or use of inappropriate components in explosive hazardous environments could cause personal injuries and damage to property.

For the application in explosion hazardous environments, the compliance of the solenoid with the zone classification and with the flammable substances present in the system must be verified.

The main safety requirements against the explosion risks in the classified areas are established by the European Directives 2014/34/UE (for the components) and 99/92/CE (for the plants and safety of the workers against the risk of explosion).

The classification criteria of the area against the explosion risks are established by the norm EN60079-10.

The technical requirements of the electrical systems are established by the norm EN60079-14 (group II).

**Note:** the max fluid temperature controlled by the valve must not exceed + 60°C



Ensure that no explosive atmosphere may occur during the valve installation.

Only use the valve in the intended explosion protection area.

The ignition temperature of the hydraulic fluid used must be 50°C higher than the maximum surface temperature of the valve.

Use of the valve outside the approved temperature ranges may lead to functional failures like e.g. overheating of the valve solenoid.

This means that the explosion protection is no longer ensured.

Only use the valve within the fluid temperature range.

During operation, touch the valve solenoid only by using protective gloves.

Unload the system pressure before working on the valve.

Danger of serious injury can be caused by a powerful leaking of hydraulic fluid jet.

Before working on the valve, ensure that the hydraulic system is depressurized and the electrical control is de-energized.

Refer to the valve specific technical tables for fastening bolts and tightening torque.

### 9.3 Electrical connection - valve off-board driver/axis controller

The connection to the external circuit is made with a screw clamps 2 poles + ground, installed inside the solenoid and transducer housing.

The eventual requirement of the additional ground connection on the solenoid housing must be made on the relative screw (M3x6 UNI-6107).

The threaded cable entrance is provided with one of following optional connections:

- conical thread 1/2" NPT ANSI B2.1
- conical thread GK-1/2" "(Annex 1 CEI EN 60079-1 2008-11) only for the Italian market
- cylindrical thread M20x1,5 UNI 4535

The cable glands used for the cable entrance must be certified for the specific hazardous environment – see tech. table **KX800** for Atos ex-proof cable glands.

**Note:** a Loctite sealant type 545, should be used on the cable gland entry threads

The electrical cables must be suitable for the working temperatures as shown in the section 9.6

### Multicertification

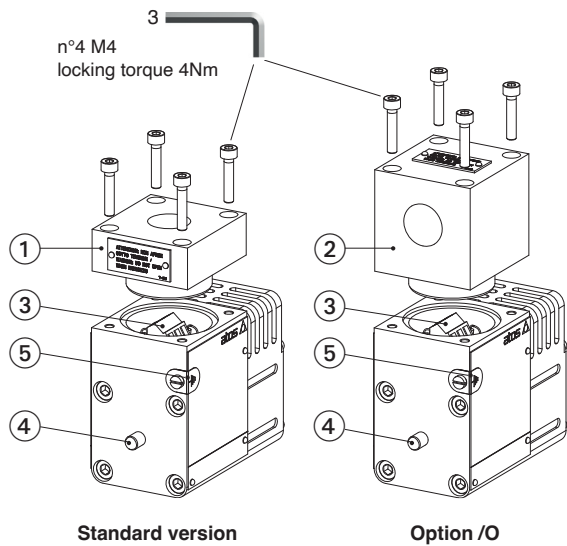

- ① cover with threaded connection for vertical cable gland fitting
- ② cover with threaded connection for horizontal cable gland fitting
- ③ terminal board for cables wiring
- ④ standard manual override
- ⑤ screw terminal for additional equipotential grounding

**1 = Coil**    PCB 3 poles terminal board suitable for wires cross sections up to 2,5 mm<sup>2</sup> (max AWG14)  
**2 = GND**  
**3 = Coil**

### cULus certification

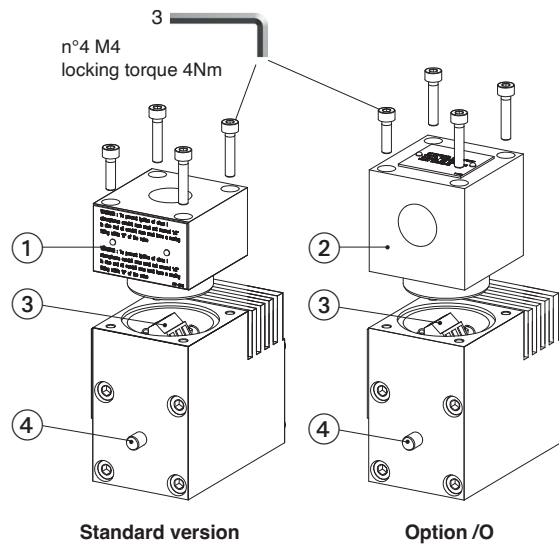

- ① cover with threaded connection for vertical cable gland fitting
- ② cover with threaded connection for horizontal cable gland fitting
- ③ terminal board for cables wiring
- ④ standard manual override

**⚠ Pay attention to coil polarity**

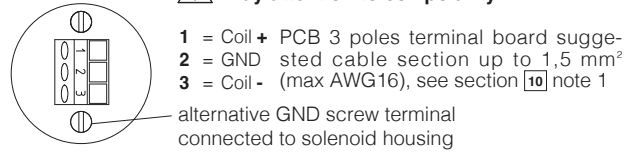

### MA chinese mining certification

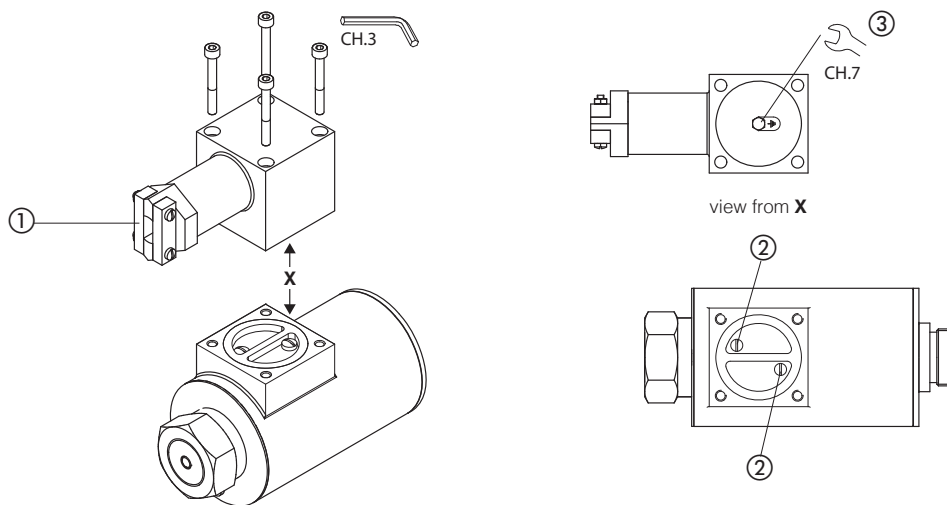

- ① cable entrance =  $\varnothing$  10,5 mm
- ② terminal board for power supply coil connection
- ③ screw terminal for ground connection

## 9.4 Cable specification and temperature

### Cable specification - Multicertification Group I and Group II

**Power supply:** section of coil connection wires = 2,5 mm<sup>2</sup>

**Grounding:** section of internal ground wire = 2,5 mm<sup>2</sup>  
section of external ground wire = 4 mm<sup>2</sup>

### Cable temperature - Multicertification Group I and Group II

| Max ambient temperature [°C] | Temperature class |         | Max surface temperature [°C] |         | Min. cable temperature [°C] |
|------------------------------|-------------------|---------|------------------------------|---------|-----------------------------|
|                              | Goup I            | Goup II | Goup I                       | Goup II |                             |
| 40 °C                        | -                 | T6      | 150 °C                       | 85 °C   | not prescribed              |
| 70 °C                        | -                 | T4      | 150 °C                       | 135 °C  | 90 °C                       |

### Cable specification - cULus certification

- Suitable for use in Class I Division 1, Gas Groups C
- Armored Marine Shipboard Cable which meets UL 1309
- Tinned Stranded Copper Conductors
- Bronze braided armor
- Overall impervious sheath over the armor

Any Listed (UBVZ/UBVZ7) Marine Shipboard Cable rated 300 V min, 15A min. 3C 2,5 mm<sup>2</sup> (14 AWG) having a suitable service temperature range of at least -25°C to +110°C ("BT" Models require a temperature range from -40°C to +110°C)

**Note 1:** For Class I wiring the 3C 1,5 mm<sup>2</sup> AWG 16 cable size is admitted only if a fuse lower than 10 A is connected to the load side of the solenoid wiring.

### Cable temperature - cULus certification

| Max ambient temperature [°C] | Temperature class | Max surface temperature [°C] | Min. cable temperature [°C] |
|------------------------------|-------------------|------------------------------|-----------------------------|
| 55 °C                        | T6                | ≤85 °C                       | ≥100 °C                     |
| 70 °C                        | T5                | ≤100 °C                      | ≥100 °C                     |

## 9.5 Hydraulic fluids and operating viscosity range

Mineral oils type HLP having high viscosity index are recommended.

The hydraulic fluids must be compatible with the selected seals.

Make sure that the working fluid is compatible with gas and dust present in the environment.

The type of fluid has to be selected in consideration of the effective working temperature range, so that the fluid viscosity remains at the optimal level.

| Hydraulic fluid               | Suitable seals type | Classification             | Ref. Standard |
|-------------------------------|---------------------|----------------------------|---------------|
| Mineral oils                  | NBR, FKM, HNBR      | HL, HLP, HLPD, HVLP, HVLPD | DIN 51524     |
| Flame resistant without water | FKM                 | HFDR, HFDR                 | ISO 12922     |
| Flame resistant with water    | NBR, HNBR           | HFC                        |               |

**Fluid viscosity:** 15 ÷ 100 mm<sup>2</sup>/s - max allowed range 2,8 ÷ 500 mm<sup>2</sup>/s

## 9.6 Filtration

The correct fluid filtration ensures a long service life of the valves and it prevent anomalous wearing or sticking.



Contamination in the hydraulic fluid may cause functional failures e.g. jamming or blocking of the valve spool / poppet.

In the worst case, this may result in unexpected system movements and thus constitute a risk of injury.

Ensure adequate hydraulic fluid cleanliness according to the cleanliness classes of the valve over the entire operating range.

### Max fluid contamination level:

ISO 4406 class 20/18/15 NAS 1638 class 9

**Note:** see also filter section at [www.atos.com](http://www.atos.com) or KTF catalog

## 10 MAINTENANCE



Maintenance must be carried out only by qualified personnel with a specific knowledge of hydraulics and electrohydraulics

### 10.1 Ordinary maintenance



Service work performed on the valve by end user or not qualified personnel invalidates the certification

- The valves does not require other maintenance operations except seals replacement
- Results of maintenance and inspection must be planned and documented
- Follow the maintenance instructions of the fluid manufacturer
- Any preventive maintenance should be performed only by experienced personnel authorized by Atos.
- Cleaning the external surfaces using a wet cloth to avoid accumulation of dust layer over 5 mm
- Don't use compressed air for cleaning to avoid any dangerous dust dispersion on the surrounding atmosphere
- Any sudden increment in temperature requires the immediate stop of the system and the inspection of the relevant components

### 10.2 Repairing

In case of incorrect functioning or beak-down it is recommended to send the valve back to Atos which will provide for the reparation. If the reparations are not made by the manufacturer, they must be performed in accordance to the criteria of IEC 60079-19 standard for IECEx and EN 60079-19 for ATEX, and by facilities having the technical know-how about the protection modes and equipped with suitable tools for repairing and controls.



Service work performed on the valve by end user or not qualified personnel invalidates the certification

Before beginning any repairing activity, the following guidelines must be observed:

- Unauthorized opening of the valves during the warranty period invalidates the warranty and invalidates the certification
- Be sure to use only original spare parts manufactured or supplied by Atos factory
- Provide all the required tools to make the repair operations safely and to don't damage the components
- Read and follow all the safety notes given in section

## 11 TRANSPORT AND STORAGE

### 11.1 Transport

Observe the following guidelines for transportation of valves:

- Before any movement check the valve weight reported in the technical table relevant to the specific component
- Use soft lifting belts to move or lift the heavy valves to avoid damages



Danger of damage to property and personal injuries!

The valve may fall down and cause damage and injuries, if transported improperly:

- Use the original packaging for transport
- Use personal protective equipment (such as gloves, working shoes, safety goggles, working clothes, etc.)



### 11.2 Storage

Valve's corrosion protection is achieved with zinc coating; this treatment protect the valve to grant a storage period up to 12 months.

Additionally all valves are tested with mineral oil OSO 46; the oil film left after testing ensure the internal corrosion protection.

In case of storage period longer than 12 months please contact our technical office.

Ensure that valves are well protected against water and humidity in case of storage in open air.

## 12 RELATED DOCUMENTATION

### Directional valves

- EX010** DHA - direct, spool type
- EX015** DHA, DKA - direct, spool type
- EX020** DLAH , DLAHM - direct, poppet type
- EX030** DPHA - piloted
- EX050** LIDEW-AO, LIDBH-AO - piloted ISO cartridges and functional covers

### Pressure relief valves

- CX010** AGAM-AO, ARAM-AO - piloted, with solenoid valve for venting