

Proportional directional valves

direct operated, open loop

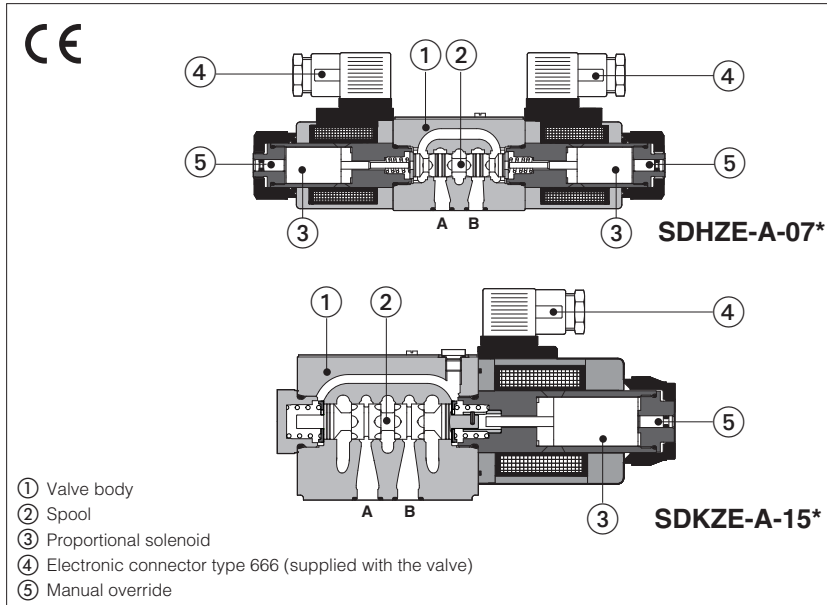

SDHZE-A, SDKZE-A

Direct operated proportional directional valves without position transducer and with positive spool overlap for open loop directional controls and not compensated flow regulations

They operate in association with electronic drivers, see section 2, which supply the proportional valves with proper current to align the valve regulation to the reference signal.

The spools are available with linear **L**, progressive **S** or differential **D** flow characteristics.

The valve body is 3 chambers type for SDHZE and SDKZE.

The solenoid coils are available with different nominal resistances depending to the voltage supply to the driver (12 VDC or 24 VDC) and to the electronic driver characteristics, see section 2 and 3.

Mounting surface: **ISO 4401**

Size: **06** and **10**

Max flow: up to **70** and **160 l/min**

Max pressure: **350 bar** (SDHZE)
315 bar (SDKZE)

1 MODEL CODE

SDHZE	-	A	-	0	71	-	S	5	/	*	-	*	/	*	**	/	*
SDHZE = size 06 SDKZE = size 10		A = open loop		Valve size - ISO 4401 0 = size 06 (SDHZE) 1 = size 10 (SDKZE)										Seals material, see section 4: - = NBR PE = FKM BT = HNBR		Series number	

Configuration:

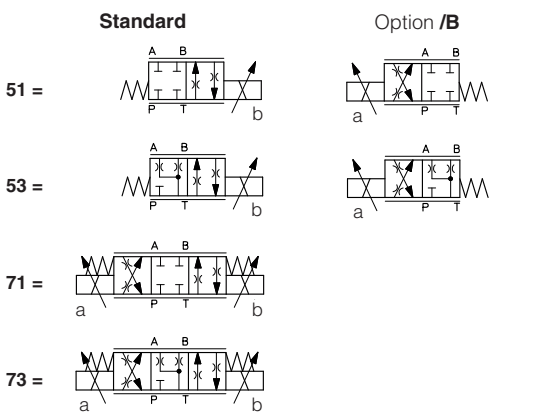

Coil option (only for -A execution)

see section 2 and 3:

- = standard coil for 24V_{DC} Atos drivers

6 = optional coil for 12V_{DC} Atos drivers

18 = optional coil for 24V_{DC} low current drivers (1)

Coils with special connectors, see section 10

- = omit for standard DIN connector

J = AMP Junior Timer connector

K = Deutsch connector

S = Lead Wire connection

Hydraulic options

B = solenoid side of port A (only for valve configuration 5)

Spool type - regulating characteristics:

L = linear

S = progressive

D = differential-progressive



P-A = Q, B-T = Q/2
P-B = Q/2, A-T = Q

Spool size: **14** (L) **1** (L) **3** (L,S,D) **5** (L,S,D)

SDHZE = 1 4,5 17 28

SDKZE = - - 45 60

Nominal flow (l/min) at Δp 10 bar P-T

(1) select valve's coil voltage /18 in case of electronic drivers not supply by Atos, with power supply 24V_{DC} and with max current limited to 1A.

2 ELECTRONIC DRIVERS - see www.atos.com or KTI industrial master catalog

Drivers model	E-MI-AC		E-MI-AS-IR		E-BM-AS-PS		E-BM-AES
Type	analog		digital		digital		digital
Voltage supply (V_{bc})	12	24	12	24	12	24	24
Valve coil option	/6	std	/6	std	/6	std	std
Format	DIN 43650 plug-in to solenoid				DIN-rail panel		
Data sheet	G010		G020		G030		GS050

3 MAIN CHARACTERISTICS - based on mineral oil ISO VG 46 at 50 °C

Assembly position	Any position					
Subplate surface finishing	Roughness index, Ra 0,4 flatness ratio 0,01/100 (ISO 1101)					
MTTFd valves according to EN ISO 13849	150 years, for further details see KT technical table P007					
Ambient temperature range	Standard and /PE = -20°C ÷ +70°C,			/BT option = -40°C ÷ +60°C		
Storage temperature range	Standard and /PE = -20°C ÷ +80°C,			/BT option = -40°C ÷ +70°C		
Coil code	SDHZE			SDKZE		
	standard	option /6	option /18	standard	option /6	option /18
Coil resistance R at 20°C	3,1 Ω	2,1 Ω	13,1 Ω	3,2 Ω	2,1 Ω	13,7 Ω
Max. solenoid current	2,5 A	3 A	1,2 A	2,2 A	2,65 A	1 A
Max. power	30W			35W		
Insulation class	H (180°) Due to the occurring surface temperatures of the solenoid coils, the European standards ISO 13732-1 and EN982 must be taken into account					
Protection degree to DIN EN60529	IP 65 (with connectors 666 correctly assembled)					
Duty factor	Continuous rating (ED=100%)					

Valve model	SDHZE				SDKZE	
Pressure limits [bar]	ports P, A, B = 350; T = 210				ports P, A, B = 315; T = 210	
Spool type and size	L14	L1	S3, L3, D3	S5, L5, D5	S3, L3, D3	S5, L5, D5
Nominal flow (1) [l/min]						
at $\Delta p = 10$ bar (P-T)	1	4,5	18	28	45	60
at $\Delta p = 30$ bar (P-T)	2	8	30	50	80	105
at $\Delta p = 70$ bar (P-T)	3	12	45	70	120	160
Response time (2) [ms]	< 30				< 40	
Hysteresis [%]	5 [% of max regulation]					
Repeatability [%]	± 1 [% of max regulation]					

Notes: above performance data refer to valves coupled with Atos electronic drivers, see section 2.
the flow regulated by the directional proportional valves is not pressure compensated, thus it is affected by the load variations. To keep constant the regulated flow under different load conditions, Atos modular pressure compensators are available at www.atos.com (see KT table D150).

(1) For different Δp , the max flow is in accordance to the diagrams in sections 7.2 and 8.2

(2) 0-100% step signal

4 SEALS AND HYDRAULIC FLUID - for other fluids not included in below table, consult our technical office

Seals, recommended fluid temperature	NBR seals (standard) = -20°C ÷ +80°C, with HFC hydraulic fluids = -20°C ÷ +50°C FKM seals (/PE option) = -20°C ÷ +80°C HNBR seals (/BT option) = -40°C ÷ +60°C, with HFC hydraulic fluids = -40°C ÷ +50°C		
Recommended viscosity	20 ÷ 100 mm ² /s - max allowed range 15 ÷ 380 mm ² /s		
Max fluid contamination level	normal operation	ISO4406 class 18/16/13 NAS1638 class 7	see also filter section at
	longer life	ISO4406 class 16/14/11 NAS1638 class 5	www.atos.com or KTF catalog
Hydraulic fluid	Suitable seals type	Classification	Ref. Standard
Mineral oils	NBR, FKM, HNBR	HL, HLP, HLPD, HVLP, HVLPD	DIN 51524
Flame resistant without water	FKM	HFDU, HFDR	ISO 12922
Flame resistant with water	NBR, HNBR	HFC	

5 GENERAL NOTES

SDHZE and SDKZE proportional valves are CE marked according to the applicable Directives (e.g. Immunity/Emission EMC Directive and Low Voltage Directive).

6 CONNECTIONS

SOLENOID POWER SUPPLY CONNECTOR TYPE 666		
PIN	Signal description	
1	SUPPLY	
2	SUPPLY	
3	GND	

7 DIAGRAMS FOR SDHZE (based on mineral oil ISO VG 46 at 50 °C)

7.1 Regulation diagrams

- 1 = linear spool L14 3 = linear spool L3 5 = linear spool L5
 2 = linear spool L1 4 = progressive spool S3, D3 6 = progressive spool S5, D5

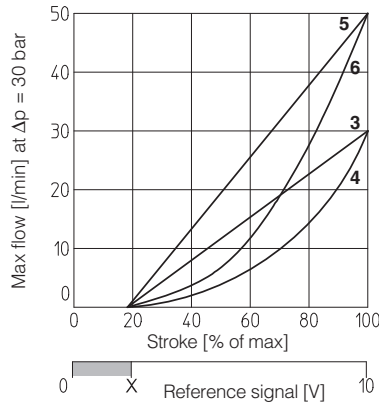
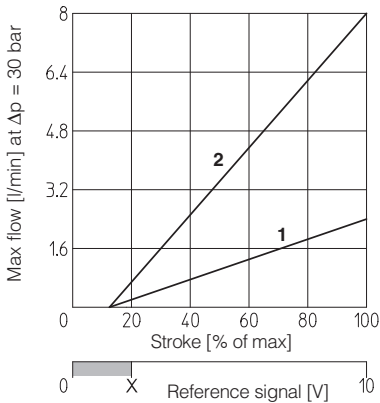

X = Threshold for bias activation depending to the valve type and amplifier type

7.2 Operating limits

- 7 = spool L14 9 = spool L3, S3, D3
 8 = spool L1 10 = spool L5, S5, D5

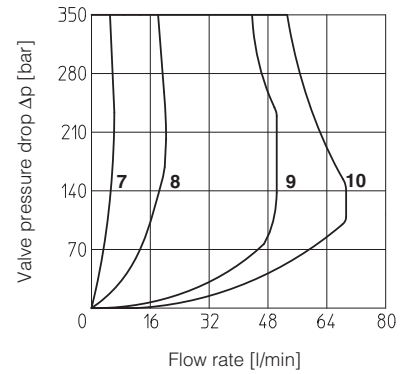

8 DIAGRAMS FOR SDKZE (based on mineral oil ISO VG 46 at 50 °C)

8.1 Regulation diagrams

- 1 = linear spool L3
 2 = progressive spool S3, D3
 3 = linear spool L5
 4 = progressive spool S5, D5

8.2 Operating limits

- 1 = spool L3, S3, D3
 2 = spool L5, S5, D5

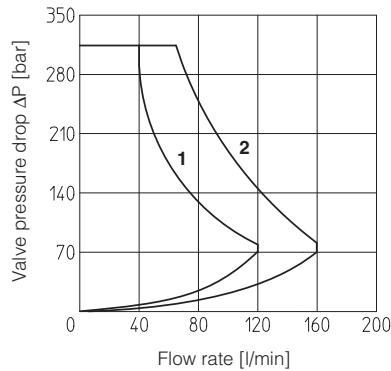
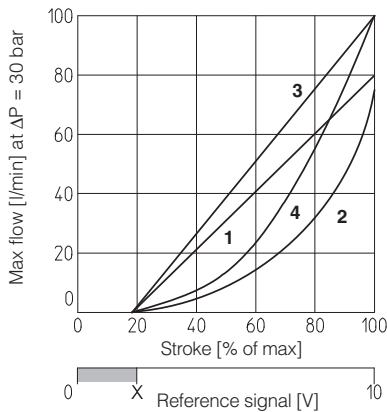

X = Threshold for bias activation depending to the valve type and amplifier type

9 OPERATION AS THROTTLE VALVE

Single solenoid valves (SDHZE-A-051 - SDKZE-A-151) can be used as simple throttle valves:
 Pmax = 210 bar

Max flow Δp= 30bar [l/min]	SPOOL TYPE					
	L14	L1	L3	S3	L5	S5
SDHZE	4	16	60		100	
SDKZE	-	-	120		150	

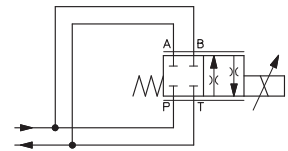

10 COILS WITH SPECIAL CONNECTORS

Options -J

- Coil type COZEJ (SDHZE)
- Coil type CAZEJ (SDKZE)
- AMP Junior Timer connector
- Protection degree IP67

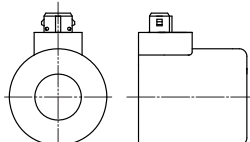

Options -K

- Coil type COZEK (SDHZE)
- Coil type CAZEK (SDKZE)
- Deutsch connector, DT-04-2P male
- Protection degree IP67

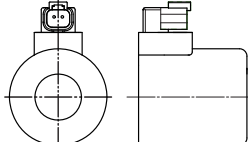

Options -S

- Coil type COZES (SDHZE)
- Coil type CAZES (SDKZE)
- Lead Wire connection
- Cable length = 180 mm

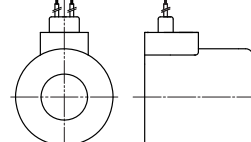

11 INSTALLATION DIMENSIONS FOR SDHZE and SDKZE [mm]

SDHZE

ISO 4401: 2005

Mounting surface: 4401-03-02-0-05

Fastening bolts: 4 socket head screws M5x30 class 12.9

Tightening torque = 8 Nm

Seals: 4 OR 108

Ports P,A,B,T: $\varnothing = 7.5$ mm (max)

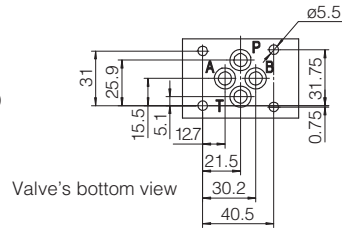

P = PRESSURE PORT
A, B = USE PORT
T = TANK PORT

SDHZE-A-05

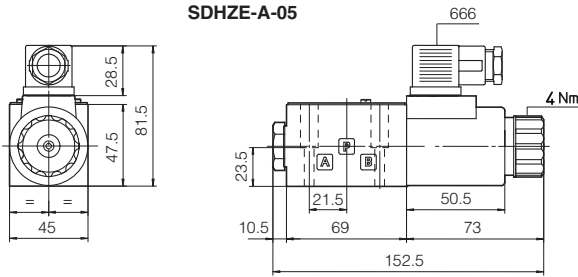

Mass: 1,5 kg

SDHZE-A-05 /B

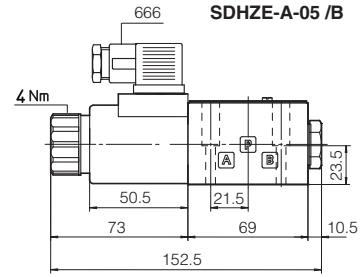

SDHZE-A-07

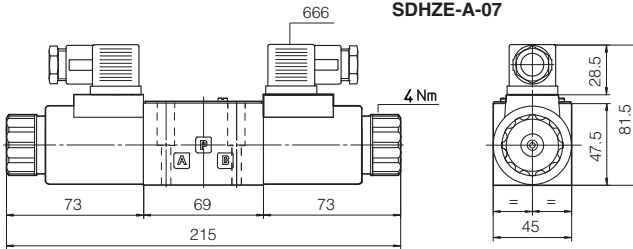

Mass: 2 kg

SDKZE

ISO 4401: 2005

Mounting surface: 4401-05-04-0-05 (see table P005)

Fastening bolts: 4 socket head screws M6x40 class 12.9

Tightening torque = 15 Nm

Seals: 5 OR 2050

Diameter of ports A, B, P, T: $\varnothing 11,2$ mm (max)

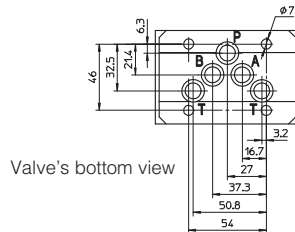

P = PRESSURE PORT
A, B = USE PORT
T = TANK PORT

SDKZE-A-15

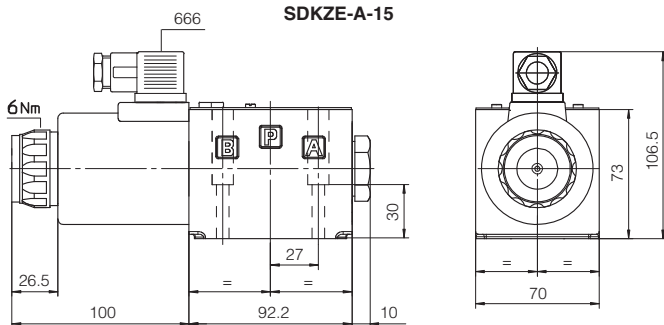

Mass: 4,5 kg

SDKZE-A-15 /B

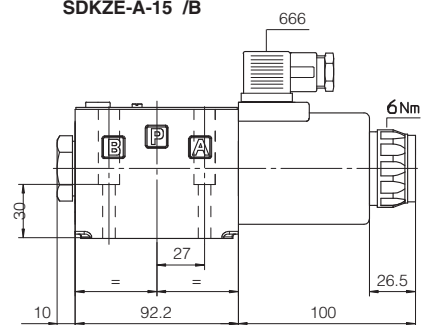

SDKZE-A-17

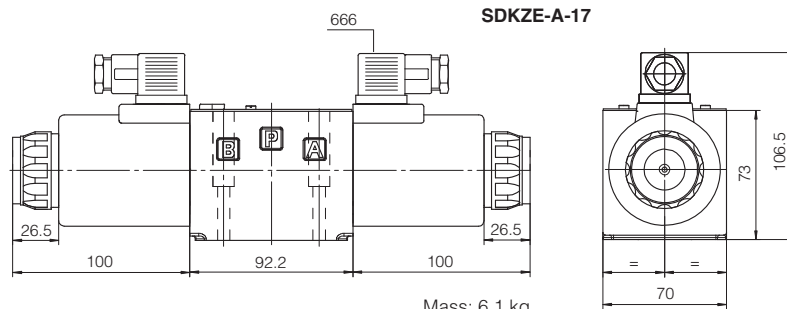

Mass: 6,1 kg