

Two stage proportional directional valves

pilot operated, open loop

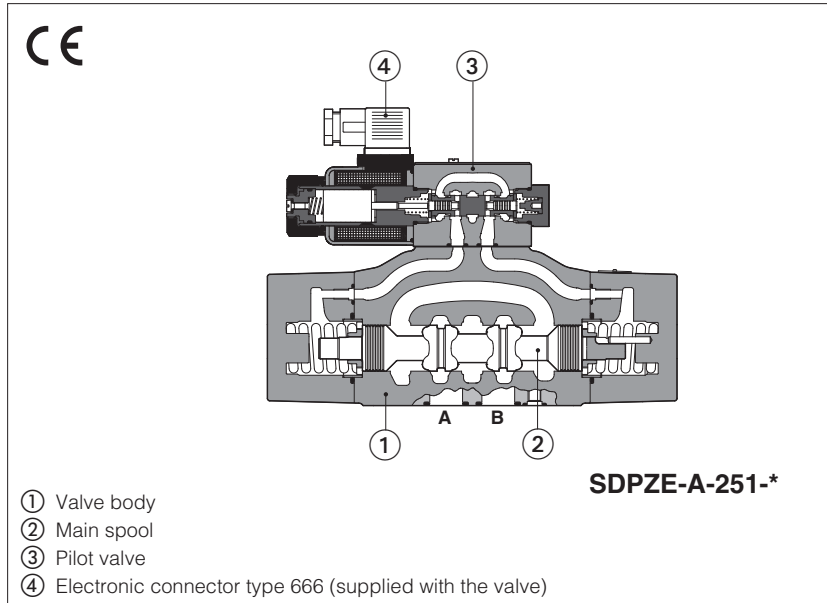

- ① Valve body
- ② Main spool
- ③ Pilot valve
- ④ Electronic connector type 666 (supplied with the valve)

SDPZE-A

Pilot operated proportional valves without position transducer and with positive spool overlap, for open loop directional controls and not compensated flow regulations.

They operate in association with electronic drivers, see section 2, which supply the proportional valve with proper current to align the valve regulation to the reference signal.

The solenoid coils are available with different nominal resistances depending to the voltage supply to the driver (12 VDC or 24 VDC) and to the electronic driver characteristics, see section 2 and 3.

Mounting surface: **ISO 4401**

Size: **16 and 25**

Max flow: **550 and 900 l/min**

Max pressure: **350 bar**

1 MODEL CODE for STANDARD SPOOLS

SDPZE	-	A	-	2	71	-	L	/	5	-	*	/	*	/	*	/	*								
Pilot operated proportional directional valve																									
A = open loop - available separated driver see section 2																									
Valve size - ISO 4401: 2 = 16 4 = 25																									
Configuration: <div style="display: flex; justify-content: space-around;"> <div style="text-align: center;"> <p>Standard</p> <p>51 = </p> <p>53 = </p> <p>71 = </p> <p>73 = </p> </div> <div style="text-align: center;"> <p>Option /B</p> <p></p> <p></p> <p></p> <p></p> </div> </div>																									
Spool type - regulating characteristics: L = linear S = progressive D = differential-progressive $P-A = Q, \quad B-T = Q/2$ $P-B = Q/2, \quad A-T = Q$																									
		<div style="border: 1px solid black; padding: 5px;"> <p>Seals material, see sect. 4:</p> <ul style="list-style-type: none"> - = NBR PE = FKM BT = HNBR <p style="text-align: center;">Series number</p> </div>																							
		<p>Coil voltage, see section 2, 3:</p> <ul style="list-style-type: none"> - = standard coil for 24V_{DC} Atos drivers 6 = optional coil for 12V_{DC} Atos drivers 18 = optional coil for low current drivers (2) 																							
		<p>Coils with special connectors, see section 10</p> <ul style="list-style-type: none"> - = omit for standard DIN connector J = AMP Junior Timer connector K = Deutsch connector S = Lead Wire connection 																							
		<p>Hydraulic options, see sect. 8:</p> <ul style="list-style-type: none"> B = solenoid at side of port B of the main stage (side A of pilot valve) (1) - only for configuration 51 and 53 D = internal drain E = external pilot pressure G = pressure reducing valve for piloting 																							
		<p>Spool size</p> <table style="width: 100%; border-collapse: collapse;"> <tr> <td></td> <td style="text-align: center;">3 (L,S,D)</td> <td style="text-align: center;">5 (L,S,D)</td> </tr> <tr> <td>SDPZE-2 =</td> <td style="text-align: center;">160</td> <td style="text-align: center;">250</td> </tr> <tr> <td>SDPZE-4 =</td> <td style="text-align: center;">-</td> <td style="text-align: center;">480</td> </tr> </table> <p>Nominal flow (l/min) at Δp 10bar P-T</p>																3 (L,S,D)	5 (L,S,D)	SDPZE-2 =	160	250	SDPZE-4 =	-	480
	3 (L,S,D)	5 (L,S,D)																							
SDPZE-2 =	160	250																							
SDPZE-4 =	-	480																							

(1) In standard configuration the solenoid (config. 51 and 53) is at side A of the main stage (side B of pilot valve)
 (2) Select valve's coil voltage /18 in case of electronic drivers not supplied by Atos, with power supply 24V_{DC} and with max current limited to 1A.

2 ELECTRONIC DRIVERS - see www.atos.com or KTI industrial master catalog

Drivers model	E-MI-AC		E-MI-AS-IR		E-BM-AS-PS		E-BM-AES
Type	analog		digital		digital		digital
Voltage supply (V _{DC})	12	24	12	24	12	24	24
Valve coil option	/6	std	/6	std	/6	std	std
Format	DIN 43650 plug-in to solenoid				DIN-rail panel		
Data sheet	G010		G020		G030		GS050

3 MAIN CHARACTERISTICS - based on mineral oil ISO VG 46 at 50 °C

Assembly position / location	Any position		
Subplate surface finishing	Roughness index Ra 0,4 - flatness ratio 0,01/100 (ISO 1101)		
MTTFd values according to EN ISO 13849	75 years, for further details see technical table P007		
Ambient temperature range	Standard and /PE = -20°C ÷ +70°C; /BT option = -40°C ÷ +60°C		
Storage temperature range	Standard and /PE = -20°C ÷ +80°C; /BT option = -40°C ÷ +70°C		
Coil code	Standard standard coil to be used with Atos drivers with power supply 24V _{DC}	option /6 optional coil to be used with Atos drivers with power supply 12 V _{DC}	option /18 optional coil to be used with electronic drivers not supplied by Atos, with power supply 24 V _{DC} and max current limited to 1A
Coil resistance R at 20°C	3,1 Ω	2,1 Ω	13,1 Ω
Max. solenoid current	2,5 A	3 A	1,2 A
Max. power	30 Watt		
Insulation class	H (180°) Due to the occurring surface temperatures of the solenoid coils, the European standards ISO 13732-1 and EN982 must be taken into account		
Protection degree to DIN EN60529	IP 65 (with connectors 666 correctly assembled)		
Duty factor	Continuous rating (ED=100%)		

Valve model	SDPZE*-2		SDPZE*-4
Pressure limits [bar]	ports P, A, B, X = 350; T = 250 (10 for option /D); Y = 10;		
Spool type	L3, S3, D3	L5, S5, D5	
Nominal flow [l/min]			
(1) Δp = 10 bar	160	250	480
Δp P-T Δp = 30 bar	270	430	830
Max permissible flow [l/min]	400	550	900
Piloting pressure [bar]	min. = 25; max = 350 (option /G advisable for pilot pressure > 150 bar)		
Piloting volume [cm ³]	3,7		9,0
Piloting flow (2) [l/min]	3,7		6,8
Leakage (3) Main stage [l/min]	0,2/0,6		0,3/1,0
Response time (4) (0-100% step signal and pilot pressure 100 bar) [ms]	< 100		< 120
Hysteresis	≤ 5 [% of max regulation]		
Repeatability	± 1 [% of max regulation]		

Notes: above performance data refer to valves coupled with Atos electronic drivers, see section 2.

(1) for different Δp, see section 7.2

(2) with step reference input signal 0 ÷ 100 %

(3) at P = 100/350 bar

(4) see detailed diagrams in section 7.3

4 SEALS AND HYDRAULIC FLUID - for other fluids not included in below table, consult our technical office

Seals, recommended fluid temperature	NBR seals (standard) = -20°C ÷ +80°C, with HFC hydraulic fluids = -20°C ÷ +50°C FKM seals (/PE option) = -20°C ÷ +80°C HNBR seals (/BT option) = -40°C ÷ +60°C, with HFC hydraulic fluids = -40°C ÷ +50°C		
Recommended viscosity	20 ÷ 100 mm ² /s - max allowed range 15 ÷ 380 mm ² /s		
Max fluid contamination level	normal operation	ISO4406 class 18/16/13 NAS1638 class 7	see also filter section at
	longer life	ISO4406 class 16/14/11 NAS1638 class 5	www.atos.com or KTF catalog
Hydraulic fluid	Suitable seals type	Classification	Ref. Standard
Mineral oils	NBR, FKM, HNBR	HL, HLP, HLPD, HVLP, HVLPD	DIN 51524
Flame resistant without water	FKM	HFDU, HFDR	ISO 12922
Flame resistant with water	NBR, HNBR	HFC	

5 GENERAL NOTES

SDPZE-A* proportional valves are CE marked according to the applicable Directives (e.g. Immunity/Emission EMC Directive and Low Voltage Directive).

6 CONNECTIONS

SOLENOID POWER SUPPLY CONNECTOR TYPE 666		
PIN	Signal description	
1	SUPPLY	
2	SUPPLY	
3	GND	

7 DIAGRAMS (based on mineral oil ISO VG 46 at 50 °C)

7.1 Regulation diagrams (values measure at Δp 10 bar P-T)

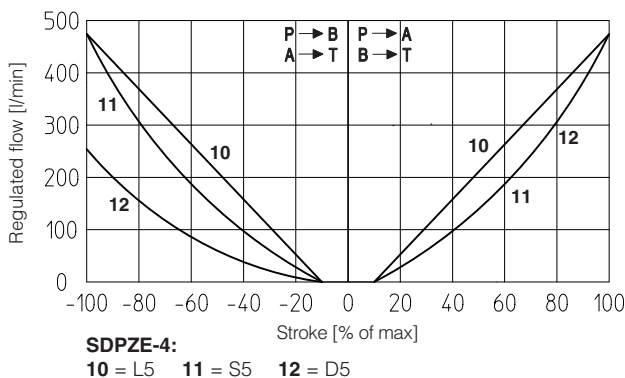
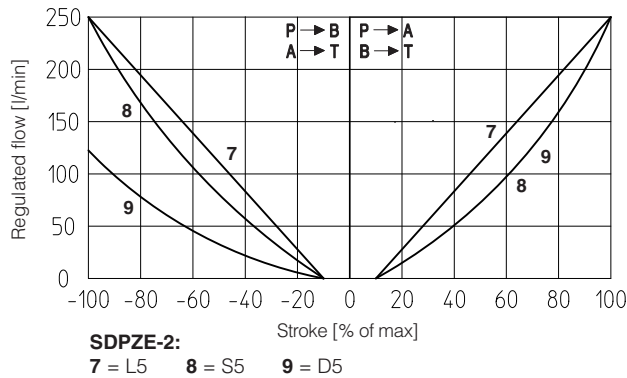
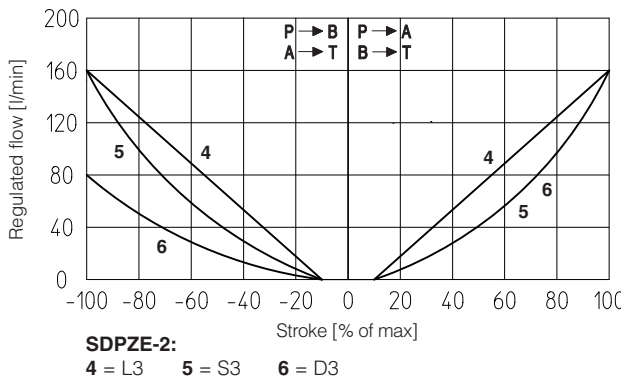

Note: Hydraulic configuration vs. reference signal for configuration 71 and 73 (standard and option /B)

Reference signal $\frac{0 \div +10 \text{ V}}{12 \div 20 \text{ mA}}$ } P → A / B → T

Reference signal $\frac{0 \div -10 \text{ V}}{12 \div 4 \text{ mA}}$ } P → B / A → T

7.2 Flow / Δp diagram

stated at 100% of spool stroke

SDPZE-2:
2 = spools L3, S3, D3
3 = spools L5, S5, D5

SDPZE-4:
4 = spools L5, S5, D5

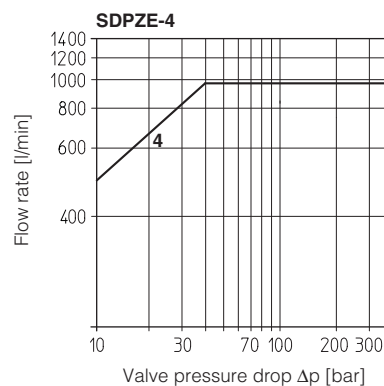
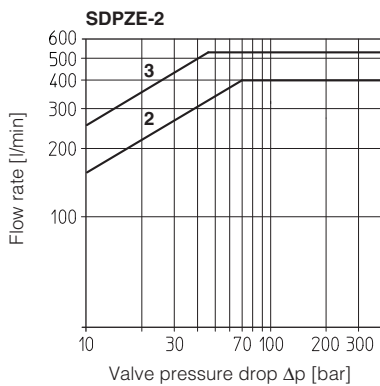

7.3 Response time (measured at pilot pressure = 100 bar)

The response times in below diagrams are measured at different steps of the reference input signal. They have to be considered as average values. For the valves with digital electronics the dynamics performances can be optimized by setting the internal software parameters.

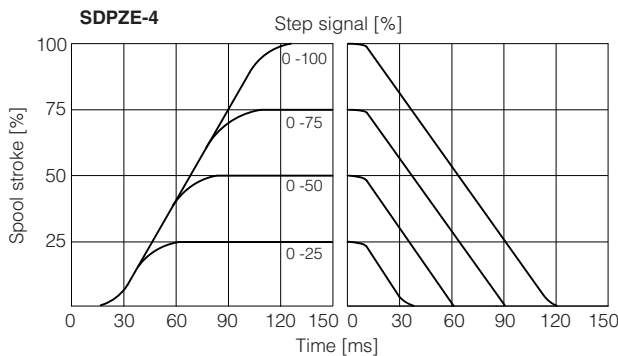
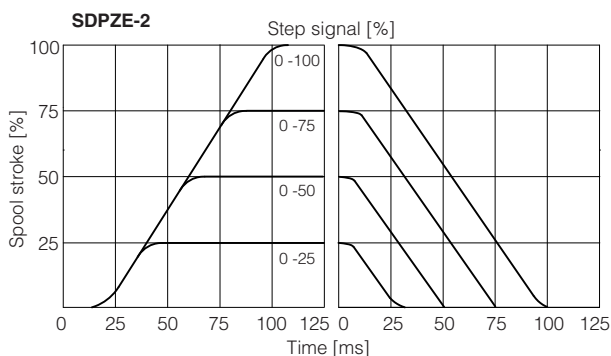

7.4 Operation as throttle valve

Single solenoid valves (*51) can be used as simple throttle valves:
 $P_{max} = 250 \text{ bar}$

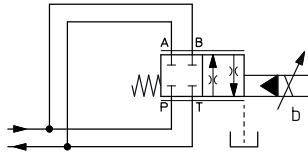

SDPZE-A*	251-L5	451-L5
Max flow [l/min]	860	1600
$\Delta p = 15 \text{ bar}$		

8 HYDRAULIC OPTIONS

8.1 Option /B

SDPZE-A-*5* = solenoid at side of port B of the main stage. Only for config. 51 and 53

8.2 Options /E and /D

Pilot and drain configuration can be modified as shown in section 9
 The valve's standard configuration provides internal pilot and external drain.
 For different pilot / drain configuration select:

- Option /E External pilot (through port X).
- Option /D Internal drain.

8.3 Option /G

Pressure reducing valve installed between pilot valve and main body with fixed setting:

- SDPZE-2 = 40 bar
- SDPZE-4 = 100 bar

It is advisable for valves with internal pilot in case of system pressure higher than 150 bar.

FUNCTIONAL SCHEME

example of configuration 7*
 3 positions, spring centered

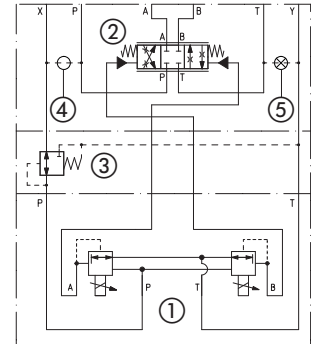

- ① Pilot valve
- ② Main stage
- ③ Pressure reducing valve
- ④ Plug to be added for external pilot trough port X
- ⑤ Plug to be removed for internal drain through port T

9 PLUGS LOCATION FOR PILOT/DRAIN CHANNELS

Depending on the position of internal plugs, different pilot/drain configurations can be obtained as shown below.

To modify the pilot/drain configuration, proper plugs must only be interchanged. The plugs have to be sealed using loctite 270.

Standard valves configuration provides internal pilot and external drain

<p>SDPZE-2 Pilot channels</p>	<p>Drain channels</p>	<p>Internal piloting: Without blinded plug SP-X300F ①; External piloting: Add blinded plug SP-X300F ①; Internal drain: Without blinded plug SP-X300F ②; External drain: Add blinded plug SP-X300F ②.</p>
<p>SDPZE-4 Pilot channels</p>	<p>Drain channels</p>	<p>Internal piloting: Without blinded plug SP-X500F ①; External piloting: Add blinded plug SP-X500F ①; Internal drain: Without blinded plug SP-X300F ②; External drain: Add blinded plug SP-X300F ②.</p>

10 COILS WITH SPECIAL CONNECTORS

Options -J

Coil type COZEJ
 AMP Junior Timer connector
 Protection degree IP67

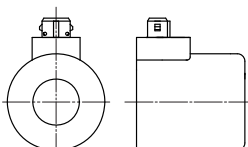

Options -K

Coil type COZEK
 Deutsch connector, DT-04-2P male
 Protection degree IP67

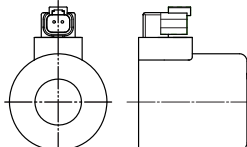

Options -S

Coil type COZES
 Lead Wire connection
 Cable lenght = 180 mm

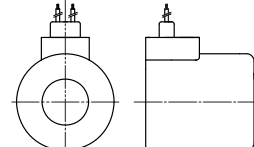

SDPZE-2*

ISO 4401: 2005

Mounting surface: 4401-07-07-0-05

Fastening bolts:

4 socket head screws M10x50 class 12.9

Tightening torque = 70 Nm

2 socket head screws M6x45 class 12.9

Tightening torque = 15 Nm

Diameter of ports A, B, P, T: $\varnothing = 20$ mm;

Diameter of ports X, Y: $\varnothing = 7$ mm;

Seals: 4 OR 130, 2 OR 2043

P = PRESSURE PORT

A, B = USE PORT

T = TANK PORT

X = EXTERNAL OIL PILOT PORT

Y = DRAIN PORT

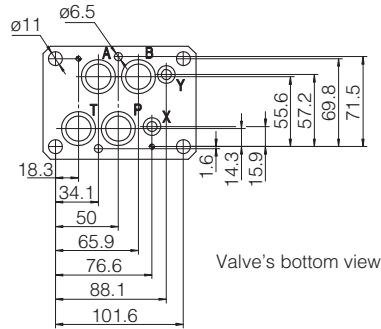

Valve's bottom view

Mass [kg]

	A
SDPZE*-25*	11,9
SDPZE*-27*	12,8
Option /G	+0,9

SDPZE-A-2

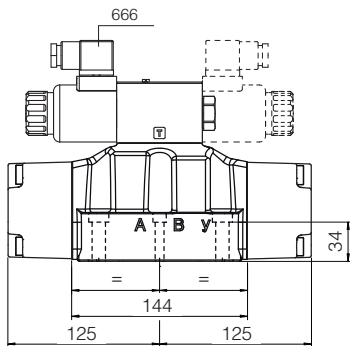

Option /G

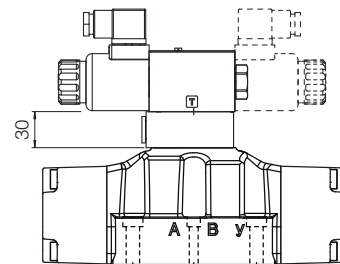

SDPZE-4*

ISO 4401: 2005

Mounting surface: 4401-08-08-0-05

Fastening bolts:

6 socket head screws M12x60 class 12.9

Tightening torque = 125 Nm

Seals: 4 OR 4112; 2 OR 3056

Diameter of ports A, B, P, T: $\varnothing = 24$ mm;

Diameter of ports X, Y: $\varnothing = 7$ mm;

P = PRESSURE PORT

A, B = USE PORT

T = TANK PORT

X = EXTERNAL OIL PILOT PORT

Y = DRAIN PORT

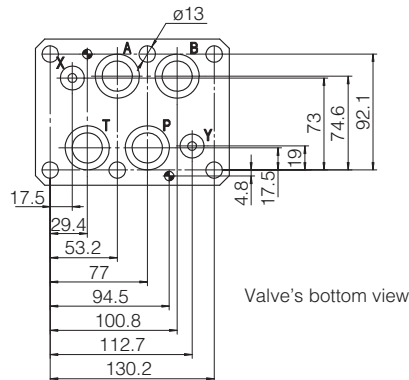

Valve's bottom view

Mass [kg]

	A
SDPZE*-45*	17,1
SDPZE*-47*	18
Option /G	+0,9

SDPZE-A-4

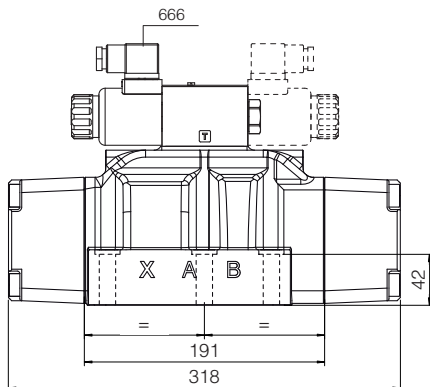

Option /G

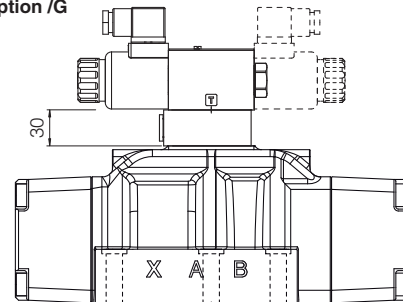

Dotted line = double solenoid version