

Proportional flow valves

direct, pressure compensated, with LVDT transducer

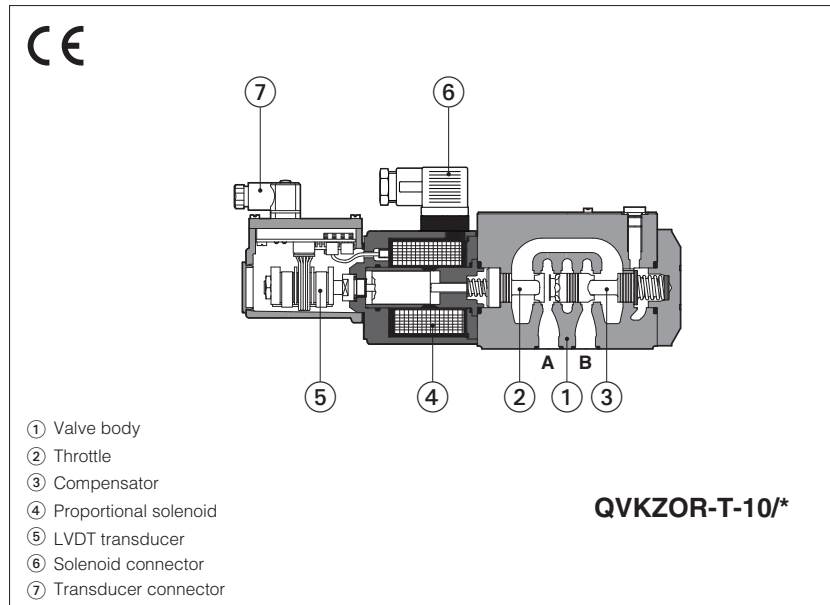

QVHZO-T, QVKZOR-T

Proportional flow control valves, direct, pressure compensated, equipped with LVDT position transducer for best accuracy in flow regulations.

The valves operate in association with digital off-board divers, see section [2](#).

The mechanical pressure compensator keeps a constant Δp across the proportional throttle, thus the regulated flow is independent to the load conditions.

The valves can be connected in 2-way or in 3-way, in this last the exceeding flow, not regulated from A to B ports, returns to tank through the P port (3rd way).

QVHZO:	QVKZOR:
Size: 06 - ISO 4401	Size: 10 - ISO 4401
Max flow: 45 l/min	Max flow: 90 l/min
Max pressure: 210 bar	Max pressure: 210 bar

1 MODEL CODE

QVKZOR	-	T	-	10	/	65	/	*	/	*								
<p>Proportional flow control valves, direct, pressure compensated</p> <p>QVHZO = size 06 QVKZOR = size 10</p>																		
<p>T = with LVDT transducer</p>																		
<p>Seals material, see section 7 :</p> <p>- = NBR PE = FKM BT = HNBR</p>																		
<p>Series number</p>																		
<p>Valve size ISO 4401: 06 = size 06 10 = size 10</p>																		
<p>Max regulated flow:</p> <table border="0" style="width: 100%;"> <tr> <td>QVHZO:</td> <td>QVKZOR:</td> </tr> <tr> <td>3 = 3,5 l/min</td> <td>36 = 35 l/min</td> </tr> <tr> <td>12 = 12 l/min</td> <td>45 = 45 l/min</td> </tr> <tr> <td>18 = 18 l/min</td> <td>90 = 90 l/min</td> </tr> </table>											QVHZO:	QVKZOR:	3 = 3,5 l/min	36 = 35 l/min	12 = 12 l/min	45 = 45 l/min	18 = 18 l/min	90 = 90 l/min
QVHZO:	QVKZOR:																	
3 = 3,5 l/min	36 = 35 l/min																	
12 = 12 l/min	45 = 45 l/min																	
18 = 18 l/min	90 = 90 l/min																	

2 HYDRAULIC SYMBOLS

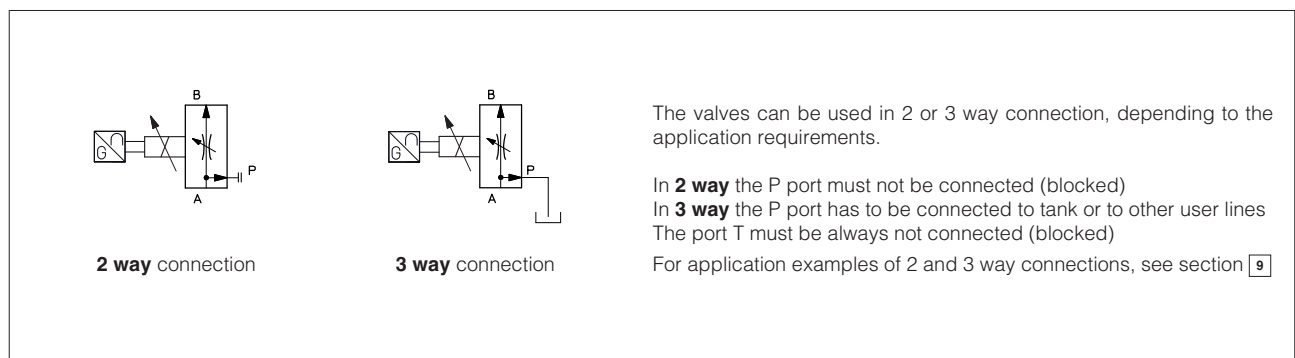

3 OFF-BOARD ELECTRONIC DRIVERS

Please include in the driver order also the complete code of the connected proportional valve.

Drivers model	E-BM-TEB	E-BM-TES
Type	digital	digital
Format	DIN-rail panel	DIN-rail panel
Tech table	GS230	GS240

4 GENERAL CHARACTERISTICS

Assembly position	Any position
Subplate surface finishing to ISO 4401	Acceptable roughness index: Ra ≤ 0,8, recommended Ra 0,4 – Flatness ratio 0,01/100
MTTFd valves according to EN ISO 13849	150 years, see technical table P007
Ambient temperature range	Standard = -20°C ÷ +60°C /PE option = -20°C ÷ +60°C /BT option = -40°C ÷ +60°C
Storage temperature range	Standard = -20°C ÷ +70°C /PE option = -20°C ÷ +70°C /BT option = -40°C ÷ +70°C
Surface protection	Zinc coating with black passivation
Corrosion resistance	Salt spray test (EN ISO 9227) > 200 h
Compliance	CE according to EMC directive 2014/30/EU (Immunity: EN 61000-6-2; Emission: EN 61000-6-3) RoHS Directive 2011/65/EU as last update by 2015/863/EU REACH Regulation (EC) n°1907/2006

5 HYDRAULIC CHARACTERISTICS - based on mineral oil ISO VG 46 at 50 °C

Valve model	QVHZO					QVKZOR		
	Max regulated flow [l/min]	3,5	12	18	35	45	65	90
Min regulated flow [cm³/min]	15	20	30	50	60	85	100	
Regulating Δp [bar]	4 - 6		10 - 12		15	6 - 8	10 - 12	
Max flow on port A [l/min]	50				60	70	100	
Max pressure [bar]	210					210		
Response time 0÷100% step signal [ms]	25					35		
Hysteresis [% of the regulated max flow]	0,5					0,5		
Linearity [% of the regulated max flow]	0,5					0,5		
Repeatability [% of the regulated max flow]	0,1					0,1		
Thermal drift	zero point displacement < 1% at ΔT = 40°C							

6 ELECTRICAL CHARACTERISTICS

Max power consumption	30 W
Max. solenoid current	QVHZO = 2,6 A QVKZOR = 3 A
Coil resistance R at 20°C	QVHZO = 3 ÷ 3,3 Ω QVKZOR = 3,8 ÷ 4,1 Ω
Insulation class	H (180°) Due to the occurring surface temperatures of the solenoid coils, the European standards ISO 13732-1 and EN982 must be taken into account
Protection degree to DIN EN60529	IP65 with mating connectors
Duty factor	Continuous rating (ED=100%)

7 SEALS AND HYDRAULIC FLUIDS - for other fluids not included in below table, consult our technical office

Seals, recommended fluid temperature	NBR seals (standard) = -20°C ÷ +80°C, with HFC hydraulic fluids = -20°C ÷ +50°C FKM seals (/PE option) = -20°C ÷ +80°C HNBR seals (/BT option) = -40°C ÷ +60°C, with HFC hydraulic fluids = -40°C ÷ +50°C		
Recommended viscosity	20÷100 mm²/s - max allowed range 15 ÷ 380 mm²/s		
Max fluid contamination level	normal operation	ISO4406 class 18/16/13 NAS1638 class 7	see also filter section at
	longer life	ISO4406 class 16/14/11 NAS1638 class 5	www.atos.com or KTF catalog
Hydraulic fluid	Suitable seals type	Classification	Ref. Standard
Mineral oils	NBR, FKM, HNBR	HL, HLP, HLPD, HVLP, HVLPD	DIN 51524
Flame resistant without water	FKM	HFDU, HFDR	ISO 12922
Flame resistant with water	NBR, HNBR	HFC	

8 DIAGRAMS - based on mineral oil ISO VG 46 at 50 °C

8.1 Regulation diagrams

- 1 = QVHZO-T-06/3
- 2 = QVHZO-T-06/12
- 3 = QVHZO-T-06/18
- 4 = QVHZO-T-06/36
- 5 = QVHZO-T-06/45
- 6 = QVKZOR-T-10/65
- 7 = QVKZOR-T-10/90

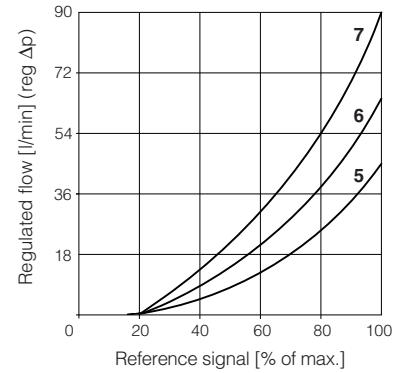
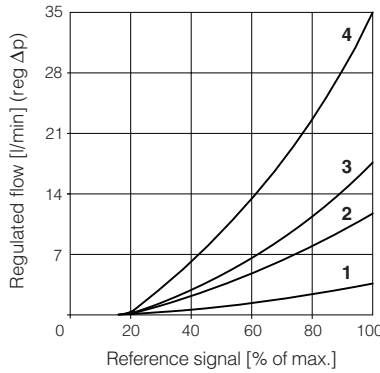

8.2 Regulated flow/outlet pressure diagrams

with inlet pressure = 210 bar

- 1 = QVHZO
- 2 = QVKZOR

Dotted line for 3-way versions

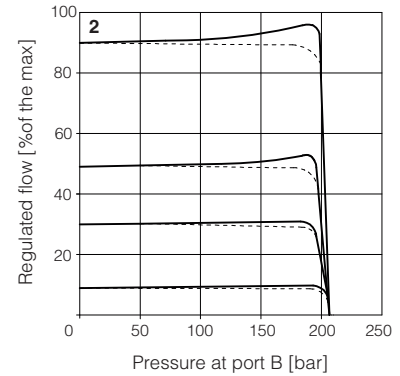
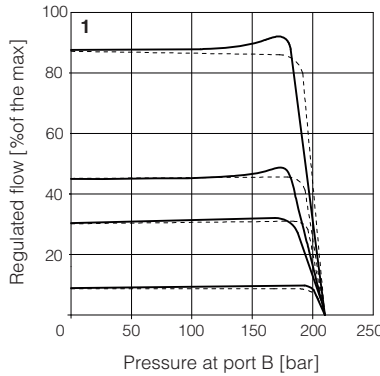

8.3 Flow A → P/Δp diagrams

3-way configuration

- 1 = QVHZO-T-06/3
- 2 = QVHZO-T-06/12
- 3 = QVHZO-T-06/18
- 4 = QVHZO-T-06/36
- 5 = QVHZO-T-06/45
- 6 = QVKZOR-T-10/65
- 7 = QVKZOR-T-10/90

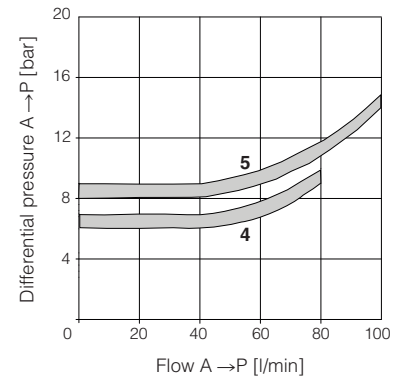
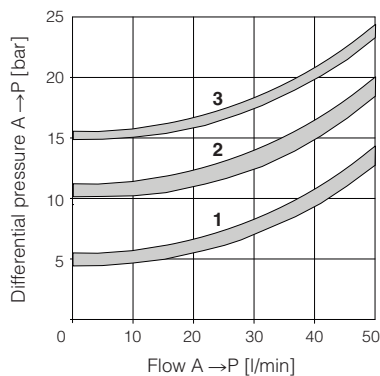

9 APPLICATIONS AND CONNECTIONS

compensated flow

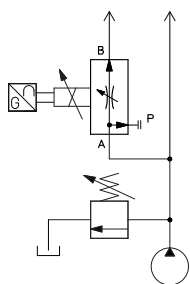

2 way connection

compensated flow

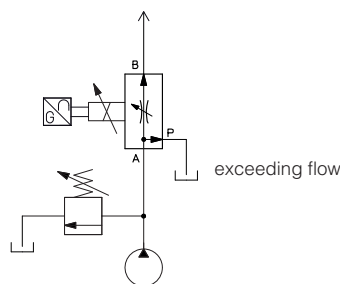

3 way connection

compensated flow
primary circuit (priority)

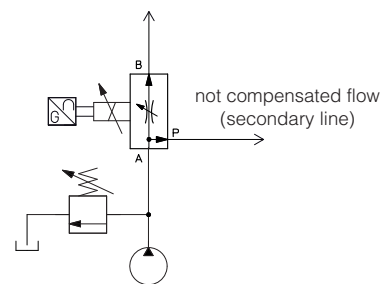

priority connection

2 way connection

The 2 way connection is normally used to control the flow in one part of the hydraulic circuit or to regulate the speed of a specific actuator. The metered flow in the controlled line is kept constant, independently to the load variations. If the valve is directly installed on the pump main line, the exceeding flow is returned to tank through the pressure relief valve.

3 way connection

The 3 way connection is normally used when the valve directly controls the pump flow (main line). The metered flow in the controlled line is kept constant, independently to the load variations. The exceeding flow (not metered by the valve) it is returned to tank through the valve P port = T line (3rd way).

Priority connection

The priority connection guarantees the pressure compensated flow supply to the primary circuit. The exceeding flow (not required by the primary circuit) is bypassed through the valve P port, to secondary circuit operating at lower pressure and not requiring compensated flow regulations.

10 ELECTRICAL CONNECTION

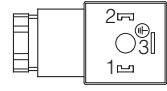

10.1 Solenoid connector - supplied with the valve

PIN	SIGNAL	TECHNICAL SPECIFICATION	Connector code 666
1	COIL	Power supply	
2	COIL	Power supply	
3	GND	Ground	

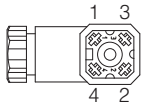
10.2 LVDT transducer connector - supplied with the valve

PIN	SIGNAL	TECHNICAL SPECIFICATION	Connector code 345
1	TR	Output signal	
2	VT-	Power supply -15Vdc	
3	VT+	Power supply +15Vdc	
4	GND	Ground	

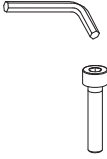
11 FASTENING BOLTS AND SEALS

	QVHZO	QVKZOR
	Fastening bolts: 4 socket head screws M5x50 class 12.9 Tightening torque = 8 Nm	Fastening bolts: 4 socket head screws M6x40 class 12.9 Tightening torque = 15 Nm
	Seals: 4 OR 108; Diameter of ports A, B, P, T: \varnothing 7,5 mm (max)	Seals: 5 OR 2050; Diameter of ports A, B, P, T: \varnothing 11,2 mm (max)

12 INSTALLATION DIMENSIONS [mm]

QVHZO-T

ISO 4401: 2005

Mounting surface: 4401-03-02-0-05 (see tab. P005)

Mass [kg]	
QVHZO-T	2,3

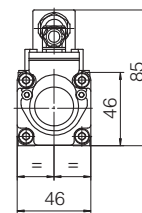
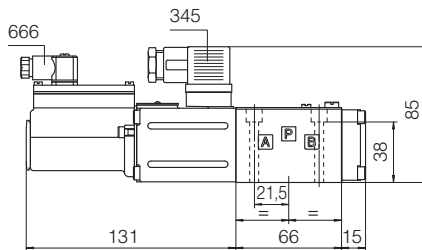

QVKZOR-T

ISO 4401: 2005

Mounting surface: 4401-05-04-0-05 (see tab. P005)

Mass [kg]	
QVKZOR-T	3,9

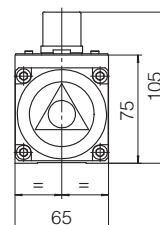
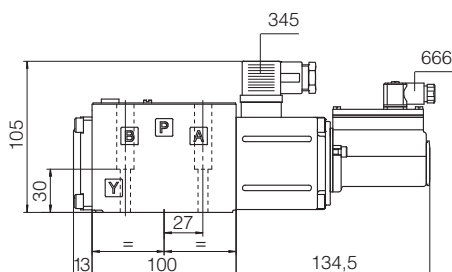

13 RELATED DOCUMENTATION

FS900 Operating and maintenance information for proportional valves
GS230 E-BM-TEB digital driver
GS240 E-BM-TES digital driver
GS500 Programming tools

GS510 Fieldbus
K800 Electric and electronic connectors
P005 Mounting surfaces for electrohydraulic valves