

Ex-proof digital proportional flow valves

pressure compensated with on-board driver and without transducer - **ATEX, IECEx, EAC, CCC**

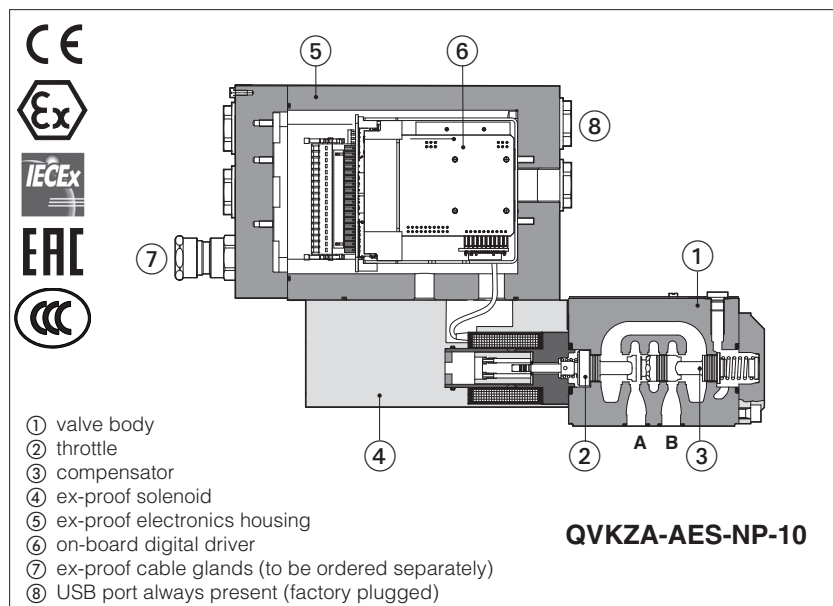

- ① valve body
- ② throttle
- ③ compensator
- ④ ex-proof solenoid
- ⑤ ex-proof electronics housing
- ⑥ on-board digital driver
- ⑦ ex-proof cable glands (to be ordered separately)
- ⑧ USB port always present (factory plugged)

QVKZA-AES-NP-10

QVHZA-AES, QVKZA-AES

Ex-proof digital proportional flow valves, without position transducer for pressure compensated flow regulations.

They are equipped with ex-proof on-board digital driver and solenoid certified for safe operations in hazardous environments with potentially explosive atmosphere.

- Multicertification **ATEX, IECEx, EAC, CCC** for gas group **II 2G** and dust category **II 2D**

The flameproof enclosure of on-board digital driver and solenoid prevents the propagation of accidental internal sparks or fire to the external environment.

The driver and solenoid are also designed to limit the surface temperature within the classified limits.

QVHZA:	QVKZA:
Size: 06 - ISO4401	Size: 10 - ISO4401
Max flow: 45 l/min	Max flow: 90 l/min
Max pressure: 210 bar	Max pressure: 210 bar

1 MODEL CODE

QVKZA	-	AES	-	NP	-	10	/	65	/	M	/	*	/	*								
<p>Ex-proof pressure compensate proportional flow valve, direct</p> <p>QVHZA = size 06 QVKZA = size 10</p>														<p>Seals material, see section 9 :</p> <p>- = NBR PE = FKM BT = HNBR</p>								
<p>AES = on-board driver, without transducer</p>																						
<p>Fieldbus interfaces, USB port always present:</p> <p>NP = Not Present BC = CANopen BP = PROFIBUS DP EH = EtherCAT</p>																						
<p>Hydraulic options (1): D = quick venting of port B</p> <p>Electronic options (1): C = current feedback for pressure transducer 4 ÷ 20 mA, only for W (omit for std voltage 0 ÷ 10 VDC) I = current reference input 4 ÷ 20 mA (omit for std voltage 0 ÷ 10 Vdc) W = power limitation function</p>																						
<p>Cable entrance threaded connection: M = M20x1,5</p>																						
<p>Valve size ISO 4401: 06 = size 06 10 = size 10</p>																						
<p>Max regulated flow:</p> <table border="0" style="width: 100%;"> <tr> <td>QVHZA:</td> <td>QVKZA:</td> </tr> <tr> <td>3 = 3,5 l/min 36 = 35 l/min</td> <td>65 = 65 l/min</td> </tr> <tr> <td>12 = 12 l/min 45 = 45 l/min</td> <td>90 = 90 l/min</td> </tr> <tr> <td>18 = 18 l/min</td> <td></td> </tr> </table>															QVHZA:	QVKZA:	3 = 3,5 l/min 36 = 35 l/min	65 = 65 l/min	12 = 12 l/min 45 = 45 l/min	90 = 90 l/min	18 = 18 l/min	
QVHZA:	QVKZA:																					
3 = 3,5 l/min 36 = 35 l/min	65 = 65 l/min																					
12 = 12 l/min 45 = 45 l/min	90 = 90 l/min																					
18 = 18 l/min																						

(1) For possible combined options, see section 15

2 HYDRAULIC SYMBOLS

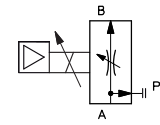

2 way connection

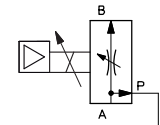

3 way connection

The valves can be used in 2 or 3 way connection, depending to the application requirements.

In **2 way** the P port must not be connected (blocked)
In **3 way** the P port has to be connected to tank or to other user lines
The port T must be always not connected (blocked)

3 GENERAL NOTES

Atos digital proportionals valves are CE marked according to the applicable directives (e.g. Immunity and Emission EMC Directive). Installation, wirings and start-up procedures must be performed according to the general prescriptions shown in tech table **FX900** and in the user manuals included in the E-SW-* programming software.

4 VALVE SETTINGS AND PROGRAMMING TOOLS

WARNING: the below operation must be performed in a safety area

Valve's functional parameters and configurations, can be easily set and optimized using Atos E-SW programming software connected via USB port to the digital driver (see table **GS003**). For fieldbus versions, the software permits valve's parameterization through USB port also if the driver is connected to the central machine unit via fieldbus.

The software is available in different versions according to the driver's options (see table **GS500**):

E-SW-BASIC support: NP (USB) PS (Serial) IR (Infrared)
E-SW-FIELDBUS support: BC (CANopen) BP (PROFIBUS DP) EH (EtherCAT)
 EW (POWERLINK) EI (EtherNet/IP) EP (PROFINET)
E-SW-*/PQ support: valves with SP, SF, SL alternated control (e.g. E-SW-BASIC/PQ)

WARNING: drivers USB port is not isolated! For E-C-SB-USB/M12 cable, the use of isolator adapter is highly recommended for PC protection

WARNING: see tech table **GS500** for the list of countries where the Bluetooth adapter has been approved

USB or Bluetooth connection

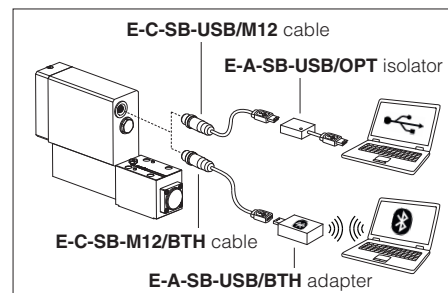

5 FIELDBUS - see tech. table **GS510**

Fieldbus allows valve direct communication with machine control unit for digital reference, valve diagnostics and settings. These executions allow to operate the valves through fieldbus or analog signals available on the terminal board.

6 GENERAL CHARACTERISTICS

Assembly position	Any position
Subplate surface finishing to ISO 4401	Acceptable roughness index, Ra ≤0,8 recommended Ra 0,4 - flatness ratio 0,01/100
MTTFd valves according to EN ISO 13849	150 years, see technical table P007
Ambient temperature range	Standard = -20°C ÷ +60°C /PE option = -20°C ÷ +60°C /BT option = -40°C ÷ +60°C
Storage temperature range	Standard = -20°C ÷ +70°C /PE option = -20°C ÷ +70°C /BT option = -40°C ÷ +70°C
Surface protection	Zinc coating with black passivation - salt spray test (EN ISO 9227) > 200 h
Compliance	Explosion proof protection, see section 10 -Flame proof enclosure "Ex d" -Dust ignition protection by enclosure "Ex t" RoHs Directive 2011/65/EU as last update by 2015/65/EU REACH Regulation (EC) n°1907/2006

7 HYDRAULIC CHARACTERISTICS - based on mineral oil ISO VG 46 at 50 °C

Valve model	QVHZA					QVKZA		
	[l/min]	[cm³/min]	[bar]	[l/min]	[bar]	[l/min]	[bar]	[l/min]
Max regulated flow	3,5	12	18	35	45	65	90	
Min regulated flow	15	20	30	50	60	85	100	
Regulating Δp	4 - 6		10 - 12		15	6 - 8	10 - 12	
Max flow on port A (1)	40		50	55	70	100		
Max pressure	210							
Response time 0÷100% step signal	≤ 35					≤ 50		
Hysteresis	≤ 5 [% of the regulated max flow]							
Linearity	≤ 3 [% of the regulated max flow]							
Repeatability	≤ 1 [% of the regulated max flow]							

(1) for different Δp, the max flow is in accordance to diagrams in section 16.3

8 ELECTRICAL CHARACTERISTICS

Power supplies	Nominal : +24 VDC Rectified and filtered : VRMS = 20 ÷ 32 VMAX (ripple max 10 % VPP)			
Max power consumption	35 W			
Analog input signals	Voltage: range ±10 VDC (24 VMAX tollerant) Current: range ±20 mA		Input impedance: Ri > 50 kΩ Input impedance: Ri = 500 Ω	
Insulation class	H (180°) Due to the occuring surface temperatures of the solenoid coils, the European standards ISO 13732-1 and EN982 must be taken into account			
Monitor outputs	Voltage: maximum range ± 5 VDC @ max 5 mA			
Enable input	Range: 0 ÷ 9 VDC (OFF state), 15 ÷ 24 VDC (ON state), 9 ÷ 15 VDC (not accepted); Input impedance: Ri > 87kΩ			
Fault output	Output range : 0 ÷ 24 VDC (ON state ≡ VL+ [logic power supply] ; OFF state ≡ 0 V) @ max 50 mA; external negative voltage not allowed (e.g. due to inductive loads)			
Pressure transducer power supply (only /W option)	+24VDC @ max 100 mA (E-ATRA-7 see tech table GX800)			
Alarms	Solenoid not connected/short circuit, cable break with current reference signal, over/under temperature, current control monitoring, power supplies level, pressure transducer failure (/W option)			
Protection degree to DIN EN60529	IP66/67 with relevant cable gland			
Duty factor	Continuous rating (ED=100%)			
Tropicalization	Tropical coating on electronics PCB			
Additional characteristics	Short circuit protection of solenoid current supply; current control by P.I.D. with rapid solenoid switching; protection against reverse polarity of power supply			
Electromagnetic compatibility (EMC)	According to Directive 2014/30/UE (Immunity: EN 61000-6-2; Emission: EN 61000-6-3)			
Communication interface	USB Atos ASCII coding	CANopen EN50325-4 + DS408	PROFIBUS DP EN50170-2/IEC61158	EtherCAT EC 61158
Communication physical layer	not insulated USB 2.0 + USB OTG	optical insulated CAN ISO11898	optical insulated RS485	Fast Ethernet, insulated 100 Base TX

Note: a maximum time of 500 ms (depending on communication type) have be considered between the driver energizing with the 24 VDC power supply and when the valve is ready to operate. During this time the current to the valve coils is switched to zero

9 SEALS AND HYDRAULIC FLUIDS - for other fluids not included in below table, consult our technical office

Seals, recommended fluid temperature	NBR seals (standard) = -20°C ÷ +60°C, with HFC hydraulic fluids = -20°C ÷ +50°C FKM seals (/PE option) = -20°C ÷ +80°C HNBR seals (/BT option) = -40°C ÷ +60°C, with HFC hydraulic fluids = -40°C ÷ +50°C		
Recommended viscosity	20÷100 mm ² /s - max allowed range 15 ÷ 380 mm ² /s		
Max fluid contamination level	normal operation	ISO4406 class 18/16/13 NAS1638 class 7	see also filter section at
	longer life	ISO4406 class 16/14/11 NAS1638 class 5	www.atos.com or KTF catalog
Hydraulic fluid	Suitable seals type	Classification	Ref. Standard
Mineral oils	NBR, FKM, HNBR	HL, HLP, HLPD, HVLP, HVLPD	DIN 51524
Flame resistant without water	FKM	HFDU, HFDR	ISO 12922
Flame resistant with water (1)	NBR, HNBR	HFC	

 The ignition temperature of the hydraulic fluid must be 50°C higher than the max solenoid surface temperature

(1) Performance limitations in case of flame resistant fluids with water:

- max operating pressure = 210 bar
- max fluid temperature = 50°C

10 CERTIFICATION DATA

Valve type	QVHZA, QVKZA		
Certifications	Multicertification Group II ATEX IECEx EAC CCC		
Solenoid certified code	OZA-AES		
Type examination certificate (1)	<ul style="list-style-type: none"> • ATEX: TUV IT 18 ATEX 068 X • IECEx: IECEx TPS 19.0004X • EAC: RU C - IT.AX38.B.00425/21 • CCC: 2021322307004057 		
Method of protection	<ul style="list-style-type: none"> • ATEX Ex II 2G Ex db IIC T6/T5/T4 Gb; Ex II 2D Ex tb IIIC T85°C/T100°C/T135°C Db • IECEx Ex db IIC T6/T5/T4 Gb Ex tb IIIC T85°C/T100°C/T135°C Db • EAC 1Ex d IIC T6/T5/T4 Gb X; Ex tb IIIC T85°C/T100°C/T135°C Db X • CCC Ex d IIC T6/T5/T4 Gb; Ex tD A21 IP66/IP67 T85°C/T100°C/T135°C 		
Temperature class	T6	T5	T4
Surface temperature	≤ 85 °C	≤ 100 °C	≤ 135 °C
Ambient temperature (2)	-40 ÷ +40 °C	-40 ÷ +55 °C	-40 ÷ +70 °C
Applicable Standards	EN 60079-0 EN 60079-31 EN 60079-1	IEC 60079-0 IEC 60079-1	IEC 60079-31:2013
Cable entrance: threaded connection	M = M20x1,5		

(1) The type examination certificates can be downloaded from www.atos.com

(2) The driver and solenoids are certified for minimum ambient temperature -40°C.
In case the complete valve must withstand with minimum ambient temperature -40°C, select **/BT** in the model code.

 **WARNING: service work performed on the valve by the end users or not qualified personnel invalidates the certification**

11 CABLE SPECIFICATION AND TEMPERATURE - Power supply and grounding cables have to comply with following characteristics:

Power supply and signals: section of wire = 1,0 mm ²	Grounding: section of external ground wire = 4 mm ²
--	---

11.1 Cable temperature

The cable must be suitable for the working temperature as specified in the "safety instructions" delivered with the first supply of the products.

Max ambient temperature [°C]	Temperature class	Max surface temperature [°C]	Min. cable temperature [°C]
40 °C	T6	85 °C	80 °C
55 °C	T5	100 °C	90 °C
70 °C	T4	135 °C	110 °C

12 CABLE GLANDS

Cable glands with threaded connections M20x1,5 for standard or armoured cables have to be ordered separately, see tech table **KX600**

Note: a Loctite sealant type 545, should be used on the cable gland entry threads

13 HYDRAULIC OPTIONS

D = This option provides a quick venting of the use port B when the valve is closed or de-energized. The valve must be connected in 3 way, with P port connected to tank. When the proportional throttle is fully closed, the valve's port B is internally connected to port P (tank), permitting a quickly decompression of the pressure in the use line. In the diagram aside are represented the venting times of **QVHZA** and **QVKZA** option /D respect to standard versions:

- 1 = standard versions
- 2 = option /D

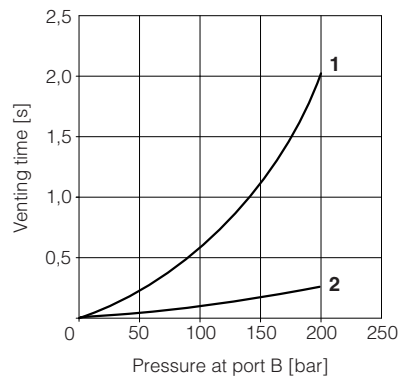

14 ELECTRONIC OPTIONS

I = It provides 4 ÷ 20 mA current reference signal, instead of the standard 0 ÷ 10 Vdc. Input signal can be reconfigured via software selecting between voltage and current, within a maximum range of ±10 Vdc or ±20 mA. It is normally used in case of long distance between the machine control unit and the valve or where the reference signal can be affected by electrical noise; the valve functioning is disabled in case of reference signal cable breakage.

C = Only in combination with option /W
It is available to connect pressure transducer with 4 ÷ 20 mA current output signal, instead of the standard 0 ÷ 10VDC .Input signal can be reconfigured via software selecting between voltage and current, within a maximum range of ±10 Vdc or ±20 mA.

W = Only for valves coupled with pressure compensator type HC-011 or KC-011 (see tech table D150). It provides the hydraulic power limitation function. The driver receives the flow reference signal by the analog input INPUT+ and a pressure transducer, installed in the hydraulic system, has to be connected to the driver's analog input TR. When the actual requested hydraulic power $p \times Q$ (TR x INPUT+) reaches the max power limit ($p_1 \times Q_1$), internally set by software, the driver automatically reduces the flow regulation of the valve. The higher is the pressure feedback the lower is the valve's regulated flow:

$$\text{Flow regulation} = \text{Min} \left(\frac{\text{PowerLimit [sw setting]}}{\text{Transducer Pressure [TR]}} ; \text{Flow Reference [INPUT+]} \right)$$

Hydraulic Power Limitation - option /W

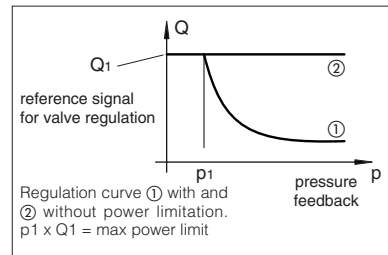

15 POSSIBLE COMBINED OPTIONS

/DI, /DW, /IW, /ICW, /ICWD

16 **DIAGRAMS** - based on mineral oil ISO VG 46 at 50 °C

16.1 Regulation diagrams

- 1 = QVHZA-*-06/3
- 2 = QVHZA-*-06/12
- 3 = QVHZA-*-06/18
- 4 = QVHZA-*-06/36
- 5 = QVHZA-*-06/45
- 6 = QVKZA-*-10/65
- 7 = QVKZA-*-10/90

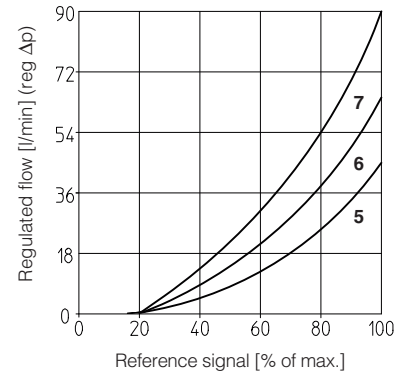
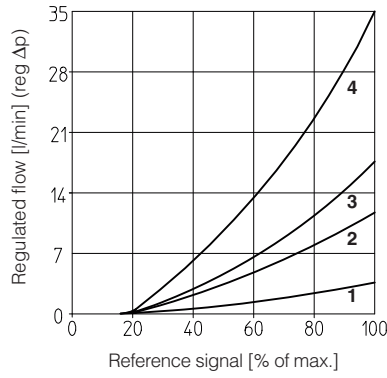

16.2 Regulated flow/outlet pressure diagrams

with inlet pressure = 210 bar

- 1 = QVHZA
- 2 = QVKZA

Dotted line for 3-way versions

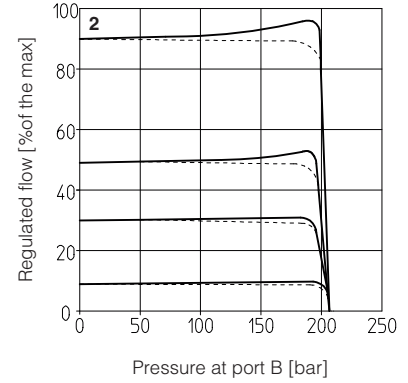
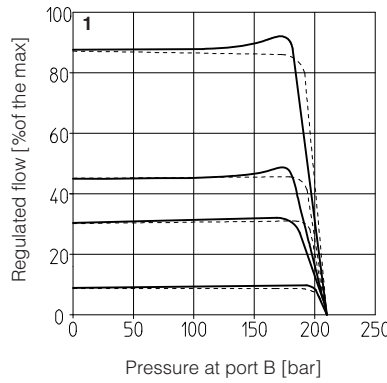

16.3 Flow A → P/Δp diagrams

3-way configuration

- 1 = QVHZA-*-06/3
- QVHZA-*-06/12
- 2 = QVHZA-*-06/18
- QVHZA-*-06/36
- 3 = QVHZA-*-06/45
- 4 = QVKZA-*-10/65
- 5 = QVKZA-*-10/90

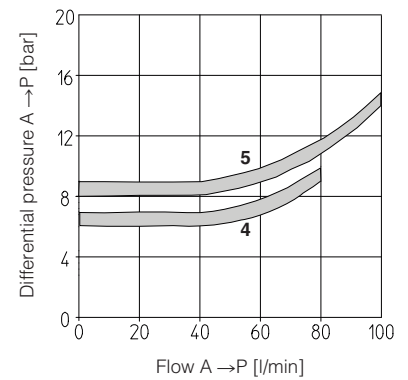
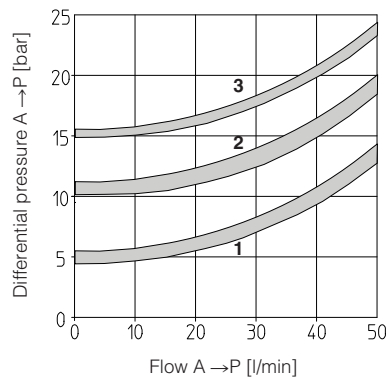

17 POWER SUPPLY AND SIGNALS SPECIFICATIONS

Generic electrical output signals of the valve (e.g. fault or monitor signals) must not be directly used to activate safety functions, like to switch-ON/OFF the machine's safety components, as prescribed by the European standards (Safety requirements of fluid technology systems and components-hydraulics, EN-982).

17.1 Power supply (V+ and V0)

The power supply must be appropriately stabilized or rectified and filtered: apply at least a 10000 $\mu\text{F}/40\text{ V}$ capacitance to single phase rectifiers or a 4700 $\mu\text{F}/40\text{ V}$ capacitance to three phase rectifiers.

 A safety fuse is required in series to each power supply: 2,5 A time lag fuse.

17.2 Power supply for driver's logic and communication (VL+ and VL0)

The power supply for driver's logic and communication must be appropriately stabilized or rectified and filtered: apply at least a 10000 $\mu\text{F}/40\text{ V}$ capacitance to single phase rectifiers or a 4700 $\mu\text{F}/40\text{ V}$ capacitance to three phase rectifiers.

The separate power supply for driver's logic on pin 3 and 4, allow to remove solenoid power supply from pin 1 and 2 maintaining active the diagnostics, USB and fieldbus communications.

 A safety fuse is required in series to each driver's logic and communication power supply: 500 mA fast fuse.

17.3 Flow reference input signal (INPUT+)

The driver controls in closed loop the valve spool position proportionally to the external reference input signal.

Reference input signal is factory preset according to selected valve code, defaults are 0 ÷ 10 VDC for standard and 4 ÷ 20 mA for /I option.

Input signal can be reconfigured via software selecting between voltage and current, within a maximum range of $\pm 10\text{ VDC}$ or $\pm 20\text{ mA}$.

Drivers with fieldbus interface can be software set to receive reference signal directly from the machine control unit (fieldbus reference). Analog reference input signal can be used as on-off commands with input range 0 ÷ 24VDC.

17.4 Monitor output signals (MONITOR and MONITOR2)

The driver generates an analog output signal (MONITOR) proportional to the actual coil current of the valve; the monitor output signal can be software set to show other signals available in the driver (e.g. analog reference, fieldbus reference).

Monitor output signal is factory preset according to selected valve code, default settings is $\pm 5\text{ VDC}$ (1V = 1A).

Output signal can be reconfigured via software, within a maximum range of $\pm 5\text{ Vdc}$.

Option /W

The driver generates a second analog output signal (MONITOR2) proportional to the actual system pressure.

The output maximum range is $\pm 5\text{ VDC}$; default setting is 0 ÷ 5 VDC

17.5 Enable input signal (ENABLE)

To enable the driver, supply a 24 VDC on pin 6: Enable input signal allows to enable/disable the current supply to the solenoid, without removing the electrical power supply to the driver; it is used to active the communication and the other driver functions when the valve must be disabled for safety reasons. This condition **does not comply** with norms IEC 61508 and ISO 13849.

Enable input signal can be used as generic digital input by software selection.

17.6 Fault output signal (FAULT)

Fault output signal indicates fault conditions of the driver (solenoid short circuits/not connected, reference signal cable broken for 4 ÷ 20 mA input, spool position transducer cable broken, etc.). Fault presence corresponds to 0 VDC, normal working corresponds to 24 VDC.

Fault status is not affected by the Enable input signal. Fault output signal can be used as digital output by software selection.

17.7 Remote Pressure Transducer Input signal (TR) - only for /W option

Analog pressure transducers can be directly connected to the driver.

Analog input signal is factory preset according to selected valve code, defaults are 0 ÷ 10 VDC for standard and 4 ÷ 20 mA for /C option.

Input signal can be reconfigured via software selecting between voltage and current, within a maximum range of $\pm 10\text{ VDC}$ or $\pm 20\text{ mA}$.

Note: transducer feedback can be read as a digital information through fieldbus communication - software selectable.

18 TERMINAL BOARD OVERVIEW

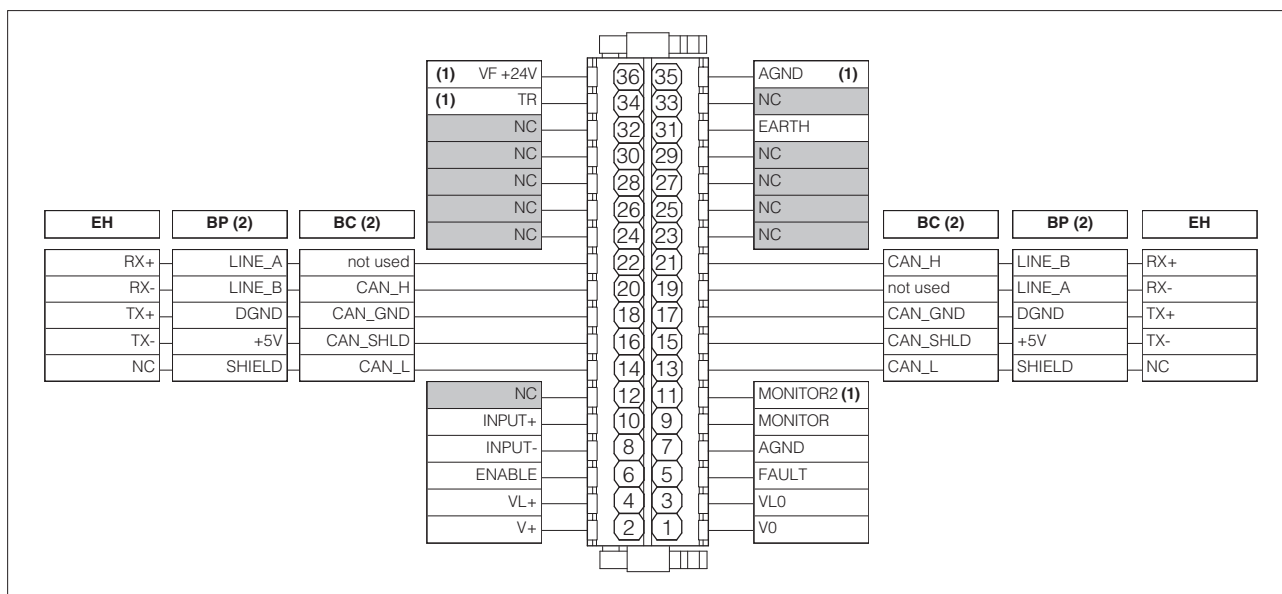

(1) Connections available only for /W option

(2) For BC and BP executions the fieldbus connections have an internal pass-through connection

19 ELECTRONIC CONNECTIONS

19.1 Main connections signals

CABLE ENTRANCE	PIN	SIGNAL	TECHNICAL SPECIFICATIONS	NOTES
A	1	V0	Power supply 0 Vdc	Gnd - power supply
	2	V+	Power supply 24 Vdc	Input - power supply
	3	VL0	Power supply 0 Vdc for driver's logic and communication	Gnd - power supply
	4	VL+	Power supply 24 Vdc for driver's logic and communication	Input - power supply
	5	FAULT	Fault (0 Vdc) or normal working (24 Vdc), referred to VL0	Output - on/off signal
	6	ENABLE	Enable (24 Vdc) or disable (0 Vdc) the driver, referred to VL0	Input - on/off signal
	7	AGND	Analog ground	Gnd - analog signal
	8	INPUT-	Negative reference input signal for INPUT+	Input - analog signal
	9	MONITOR	Monitor output signal: ± 5 Vdc maximum range, referred to AGND Default is: ± 5 Vdc	Output - analog signal Software selectable
	10	INPUT+	Reference input signal: ± 10 Vdc / ± 20 mA maximum range Defaults are: 0 ÷ 10 Vdc for standard and 4 ÷ 20 mA for /I option	Input - analog signal Software selectable
	11	MONITOR2	2nd monitor output signal: ± 5 Vdc maximum range, referred to AGND (1) Default is: 0 ÷ 5 Vdc	Output - analog signal Software selectable
31	EARTH	Internally connected to driver housing		

(1) 2nd monitor output signal is available only for /W option

19.2 USB connector - M12 - 5 pin always present

CABLE ENTRANCE	PIN	SIGNAL	TECHNICAL SPECIFICATIONS
B	1	+5V_USB	Power supply
	2	ID	Identification
	3	GND_USB	Signal zero data line
	4	D-	Data line -
	5	D+	Data line +

Driver view
(female)

19.3 BC fieldbus execution connections

CABLE ENTRANCE	PIN	SIGNAL	TECHNICAL SPECIFICATIONS
C1	14	CAN_L	Bus line (low)
	16	CAN_SHLD	Shield
	18	CAN_GND	Signal zero data line
	20	CAN_H	Bus line (high)
	22	not used	Pass-through connection (1)

CABLE ENTRANCE	PIN	SIGNAL	TECHNICAL SPECIFICATIONS
C2	13	CAN_L	Bus line (low)
	15	CAN_SHLD	Shield
	17	CAN_GND	Signal zero data line
	19	not used	Pass-through connection (1)
	21	CAN_H	Bus line (high)

(1) pin 19 and 22 can be fed with external +5V supply of CAN interface

19.4 BP fieldbus execution connections

CABLE ENTRANCE	PIN	SIGNAL	TECHNICAL SPECIFICATIONS
C1	14	SHIELD	
	16	+5V	Power supply
	18	DGND	Data line and termination signal zero
	20	LINE_B	Bus line (low)
	22	LINE_A	Bus line (high)

CABLE ENTRANCE	PIN	SIGNAL	TECHNICAL SPECIFICATIONS
C2	13	SHIELD	
	15	+5V	Power supply
	17	DGND	Data line and termination signal zero
	19	LINE_A	Bus line (high)
	21	LINE_B	Bus line (low)

19.5 EH fieldbus execution connections

CABLE ENTRANCE	PIN	SIGNAL	TECHNICAL SPECIFICATIONS
C1 (input)	14	NC	do not connect
	16	TX-	Transmitter
	18	TX+	Transmitter
	20	RX-	Receiver
	22	RX+	Receiver

CABLE ENTRANCE	PIN	SIGNAL	TECHNICAL SPECIFICATIONS
C2 (output)	13	NC	do not connect
	15	TX-	Transmitter
	17	TX+	Transmitter
	19	RX-	Receiver
	21	RX+	Receiver

19.6 Remote pressure transducer connector - only for /W option

CABLE ENTRANCE	PIN	SIGNAL	TECHNICAL SPECIFICATIONS	NOTES	Voltage	Current
D	34	TR	Signal transducer ± 10 Vdc / ± 20 mA maximum range	Input - analog signal Software selectable	Connect	Connect
	35	AGND	Common gnd for transducer power and signals	Common gnd	Connect	/
	36	VF +24V	Power supply +24Vdc	Output - power supply	Connect	Connect

E-ATRA remote pressure transducer connection - see tech table **GX800**

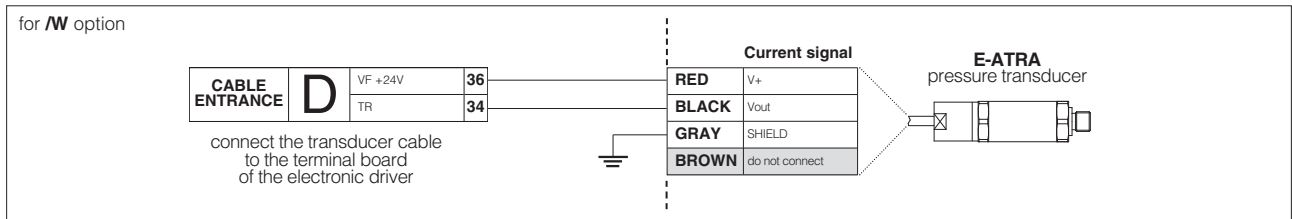

20 CONNECTIONS LAYOUT

CABLE ENTRANCE OVERVIEW

Cables entrance description:

- (A) main connections
- (B) USB connector always present (factory plugged)
- (C1) fieldbus interface (input)
- (C2) fieldbus interface (output)
- (D) pressure transducer (only /W option)
- (P) Threaded plug

TERMINAL BOARD AND FIELDBUS TERMINATOR

Remove the 4 screws of driver's rear cover to access terminal board and fieldbus terminator

Screw terminal for additional equipotential grounding

5 n°4 M6 Tightening torque **15 Nm**

WARNING: the above operation must be performed in a safety area

Terminal board - see section 18

Fieldbus terminator only for BC and BP executions (1)

BC - CANopen setting:

Switch	Termination enabled
1	OFF
2	OFF
3	OFF
4	ON

BP - PROFIBUS DP setting:

Switch	Termination enabled
1	ON
2	ON
3	ON
4	OFF

USB CONNECTOR

USB **E-C-SB-USB/M12** USB CABLE cable length 4m

male (2)

DO NOT REMOVE

METALLIC PROTECTION CAP

- supplied with the valves

Tightening torque: **20 Nm**

DO NOT REMOVE

(1) Drivers with BC and BP fieldbus interface are delivered by default 'Not Terminated'. All switches are set OFF
 (2) Pin layout always referred to driver's view

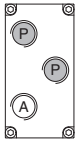
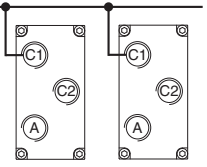
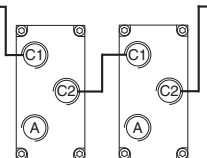

20.1 Cable glands and threaded plug for AES - see tech table KX800

Communication interfaces	To be ordered separately				Cable entrance overview	Notes
	Cable gland quantity	entrance	Threaded plug quantity	entrance		
NP	1	A	none	none		Cable entrance P are factory plugged Cable entrance A is open for costumers
BC, BP, EH "via stub" connection	2	C1 A	1	C2		Cable entrance A, C1, C2 are open for costumers
BC, BP, EH "daisy chain" connection	3	C1 C2 A	none	none		Cable entrance A, C1, C2 are open for costumers

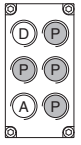
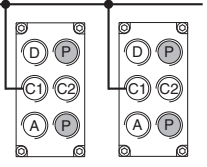
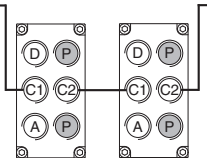
20.2 Cable glands and threaded plug for AES with /W option - see tech table KX800

Communication interfaces	To be ordered separately				Cable entrance overview	Notes
	Cable gland quantity	entrance	Threaded plug quantity	entrance		
NP	2	D A	none	none		Cable entrance P are factory plugged Cable entrance A, D are open for costumers
BC, BP, EH "via stub" connection	3	D C1 A	1	C2		Cable entrance P are factory plugged Cable entrance A, C1, C2, D are open for costumers
BC, BP, EH "daisy chain" connection	4	D C1 - C2 A	none	none		Cable entrance P are factory plugged Cable entrance A, C1, C2, D are open for costumers

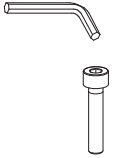
21 FASTENING BOLTS AND SEALS

	QVHZA	QVKZA
	<p>Fastening bolts: 4 socket head screws M5x50 class 12.9 Tightening torque = 8 Nm</p>	<p>Fastening bolts: 4 socket head screws M6x40 class 12.9 Tightening torque = 15 Nm</p>
	<p>Seals: 4 OR 108; Diameter of ports A, B, P, T: Ø 7,5 mm (max)</p>	<p>Seals: 5 OR 2050; Diameter of ports A, B, P, T: Ø 11,2 mm (max)</p>

22 INSTALLATION DIMENSIONS [mm]

QVHZA-AES

ISO 4401: 2005

Mounting surface: 4401-03-02-0-05 (see tab. P005)

Mass [kg]	
QVHZA-AES	8,2

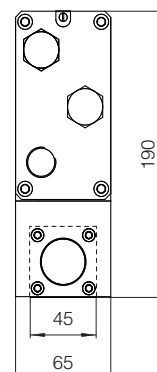
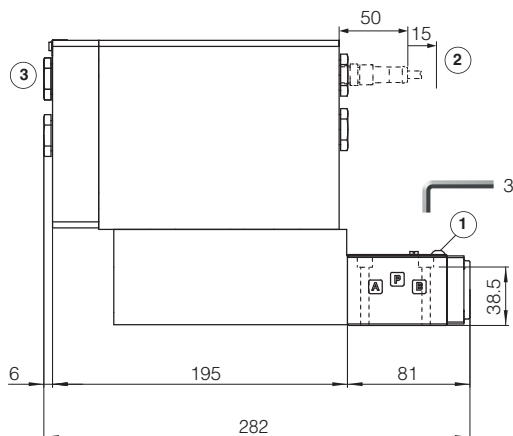

QVKZA-AES

ISO 4401: 2005

Mounting surface: 4401-05-04-0-05 (see tab. P005)

Mass [kg]	
QVKZA-AES	10

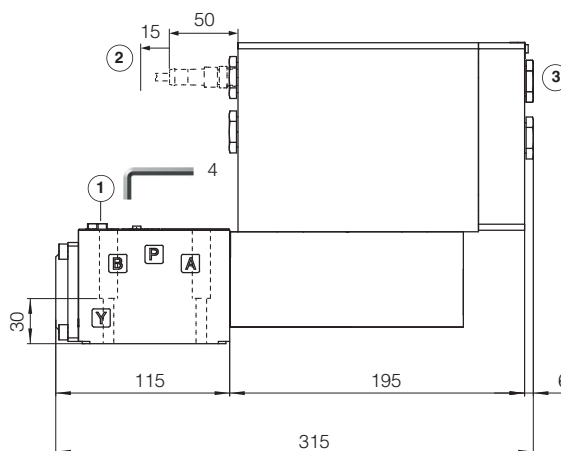
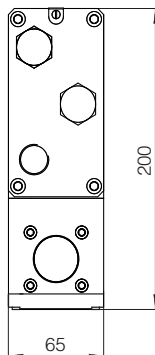

- ① = Air bleed off
- ② = Space to remove the USB connector
- ③ = The dimensions of cable glands must be considered (see tech table **KX800**)

23 RELATED DOCUMENTATION

X010 Basics for electrohydraulics in hazardous environments
X020 Summary of Atos ex-proof components certified to ATEX, IECEx, EAC, CCC, PESO
FX900 Operating and maintenance information for ex-proof proportional valves

GS500 Programming tools
GS510 Fieldbus
KX800 Cable glands for ex-proof valves
P005 Mounting surfaces for electrohydraulic valves