

DIRECT OPERATED PROPORTIONAL DIRECTIONAL VALVES

Valve model:
DHZE-TID
DKZE-TID
Driver model:
E-RI-TID-N-BC

IDENTIFICATION

Valve identification plates and label

Valve and driver name plate : L

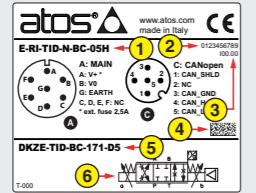
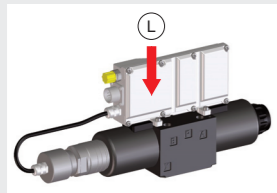

- 1 : driver code
- 2 : driver serial number
- 3 : factory firmware version
- 4 : valve matrix code
- 5 : valve code
- 6 : hydraulic symbol

INSTALLATION TOOLS ACCORDING TO VALVE MODEL- not included

Fastening bolts	Wrenches	Main connector	Fieldbus connector
socket head screws	for fastening bolts	7 pin - metallic	5 pin - metallic
see STEP 1		see STEP 2.1	see STEP 2.2

PROGRAMMING TOOLS - not included

PC software	Cable	CANopen connection	Adapter
E-SW-SETUP	E-C-BC-DB9/M12	E-TRM-BC-DB9/DB9	E-A-BC-USB/DB9

PC SOFTWARE

E-SW-SETUP	supports	NP (USB)	IL (IO-Link)	PS (Serial)	IR (Infrared)
		BC (CANopen)	BP (PROFIBUS DP)	EH (EtherCAT)	
		EW (POWERLINK)	EI (EtherNet/IP)	EP (PROFINET RT/IRT)	
	supports	valves with SP, SF, SL alternated p/Q control			

REMARK Atos PC software is designed for Windows based operative systems - Windows 10 or later

PC SOFTWARE DOWNLOAD

Download PC software at www.atos.com accessing to "MyAtos -> Download area electronics"

Free registration by filling the form at www.atos.com/en-it/login

E-SW-SETUP is free and available in Download area

RELATED DOCUMENTATION - www.atos.com

FS900 Operating and maintenance information - tech. table	E-MAN-RI-TID TID - driver operating manual
FS155 DHZE, DKZE servoproportional - tech. table	E-MAN-S-BC CANopen protocol programming manual
P005 Mounting surfaces - tech. table	
GS500 Programming tools - tech. table	
GS510 Fieldbus - tech. table	
K800 Electric and electronic connectors - tech. table	

ATTENTION !

The purpose of this quickstart guide is show a logical sequence of basic operations. This guide does not cover all details or variants of Atos valves. All operations described in this document should be performed only by qualified personnel. Operations and images could be subject to change without notice. For further information please refer to related documentation.

CONTACT US

PRODUCTS OVERVIEW

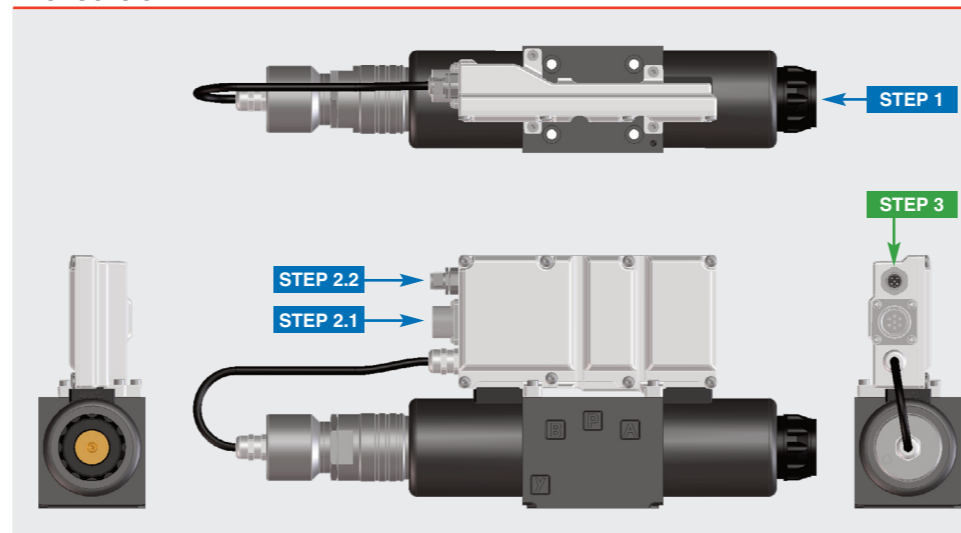

INSTALLATION		PROGRAMMING
STEP 1	STEP 2	STEP 3
MECHANICAL	ELECTRICAL	PC SOFTWARE

STEP 1 MECHANICAL

In case of first commissioning, before the valve installation the whole system must be correctly flushed to grant the required cleanliness level
During the flushing operation use on-off or by-pass valves in place of the proportional valve

- remove protection pad **P1** located on the valve bottom face only immediately before installation (do not remove connectors caps)
- check the presence and correct positioning of the seals on valve ports
- verify that valve mounting surface is clean and free from damages or burrs
- verify the correct valve orientation according to the pattern of the relevant mounting interface
- lock the fastening bolts respecting below sequence and tightening torque according to valve model

DHZE-TID		DKZE-TID	
Mounting surface layout	n°1 OR 2025 for option /Y	Mounting surface layout	n°1 OR 108 for option /Y
4401-03-02-0-05 4401-03-03-0-05 (for /Y without X port) Valve size ISO 4401: 06		4401-05-04-0-05 4401-05-05-0-05 (for /Y without X port) Valve size ISO 4401: 10	
Fastening bolts socket head screws	Tightening torque: 8 Nm	Fastening bolts socket head screws	Tightening torque: 15 Nm
n°4 M5x50 class:12.9	wrench 4 mm	n°4 M6x40 class:12.9	wrench 5 mm

STEP 2 ELECTRICAL

To proceed with the wiring of the main and CANopen connectors, perform the following steps.

2.1 MAIN CONNECTOR

1 Remove main connector cap **P2**

WARNING: remove power supply before any electrical or wiring operations

2 Proceed with wirings operations

A	V+ (power supply 24Voc)
B	V0 (power supply 0Voc)
C	
D	NC (do not connect)
E	
F	
G	EARTH

Recommended LiYCY shielded cables:
7 x 0,75 mm² max 20 m
7 x 1 mm² max 40 m

3 Connect the valve to the system

NOTE: the use of above metallic connectors is strongly recommended in order to fulfill EMC requirements

WARNING: a safety fuse is required in series to driver power supply - 2,5 A time lag fuse

2.2 FIELDBUS CONNECTOR - BC CANopen

1 Remove CANopen connector cap **P3**

2 Proceed with wirings operations

1	CAN_SHLD Shield
2	not used
3	CAN_GND Signal zero data line
4	CAN_H Bus line (high)
5	CAN_L Bus line (low)

M12 Coding A
Cable diameter
6 ÷ 8 mm

3 Connect the valve to the fieldbus network. For information about fieldbus terminators see **GS500**

NOTE: the use of above metallic connectors is strongly recommended in order to fulfill EMC requirements

STEP 3 PC SOFTWARE

REMARK proportional valves with on-board electronics are factory preset with default parameters, only few programming operations are mandatory for setup the network parameters
Valve programming can be performed through E-SW-SETUP software or via fieldbus

3.1 CONNECTION

1 In order to access valve parameterization:
• Install E-SW-SETUP software on PC
• Insert main connector to the valve and power on with 24Vdc

2 Remove CANopen connector cap **P3** and connect valve to the PC as show below

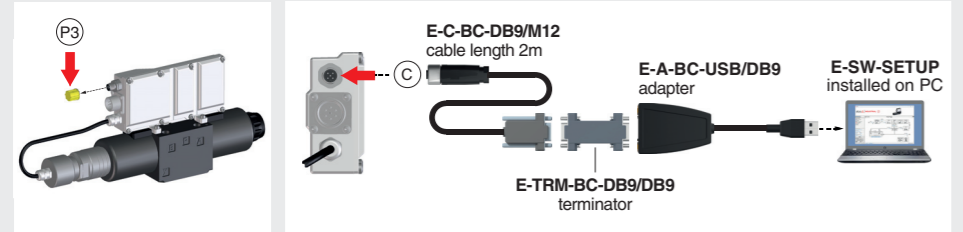

3 Launch the PC software using E-SW-SETUP icon:
• PC software does NOT detect valid connection communication is not established, please follow manual procedure **4**
• PC software detects valid connection communication automatically established - valve is ON-LINE see **5**

4 In ON-LINE - Manual press button **a** and follow the instructions shown on the side

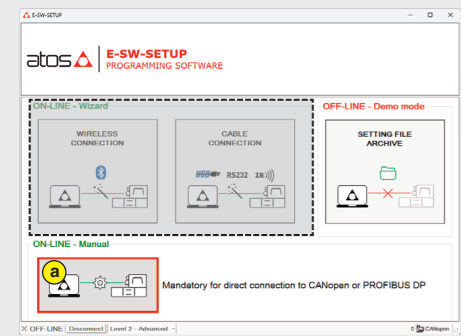

In **Communication Type** perform the following settings:
• Interface = CANopen
• Speed = 50Kbit/sec
• Node = 1

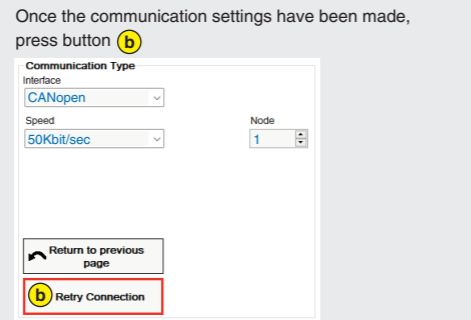

NOTE: for E-RI-TID-N-BC the ON-LINE - Wizard are not available

5 Communication established, valve is ON-LINE and it is possible change parameters

NOTE: see step 3.2 to change the network setup

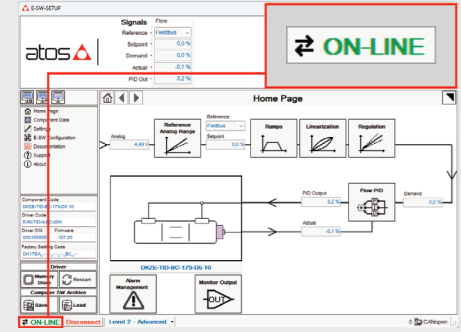

3.2 FIELDBUS - Network Management

CANopen Node and Speed can be set through:

- Machine central unit (master)**
please refer to E-MAN-S-BC fieldbus protocol programming manual
- E-SW-SETUP software**
 - browse to **Network Management - Configuration** to change default settings as shown in the image opposite
 - press **Memory Store** button and press **Save User Set** button to save new setting into the driver (see 3.4)
 - network configuration settings will be applied at next driver power on or pressing the **Restart** button

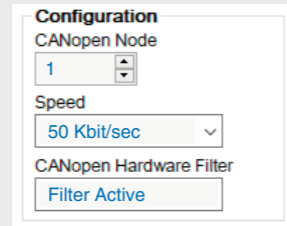

NOTE: CANopen EDS configuration file is available in MyAtos area - www.atos.com

3.3 CONFIGURATION

Single solenoid directional control valve, 2 positions with positive overlapping and flow control valve

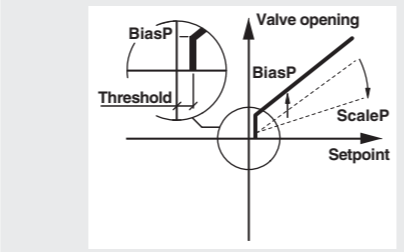

BiasP positive bias
ScaleP positive scale

Threshold = 2%
(200mV or 0,32mA for I option)

Double solenoid directional control valve, 3 positions with positive overlapping

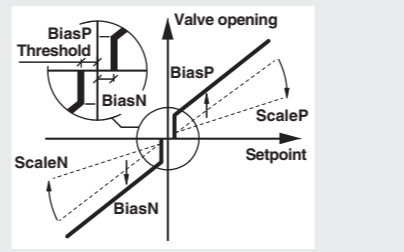

BiasP positive bias
ScaleP positive scale
BiasN negative bias
ScaleN negative scale

Threshold = 2%
(±200mV or ±0,16mA for I option)

BIAS AND SCALE - 2 POSITION VALVES and FLOW CONTROL VALVES

Bias setting: supply input signal just over the Threshold value; increase the Bias until the actuator is start moving, then lightly reduce the Bias just to stop the actuator
Scale setting: supply the max input signal; adjust the Scale to obtain the max actuator speed

BIAS AND SCALE - 3 POSITION VALVES

Follow the same indications reported for 2 position valves and flow controls valves for both valve's solenoids

RAMPS

Ramps setting: select the required ramp configuration and adjust the ramp time to optimize the actuator's acceleration and deceleration

- No Ramp : no ramps selected
- Single Ramp : setup Ramp 1
- Double Ramp : setup Ramp 1 and 2
- Four Ramps : setup Ramp 1, 2, 3 and 4 (only 3 position)

3.4 STORE

Parameters modifications will be stored into driver permanent memory:

- press **Memory Store** button to access **Driver - Memory Save** window
- press **Save User Set** button to store **Valve Parameters**

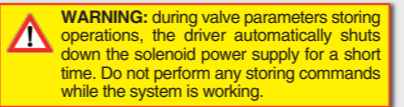

3.5 BACK UP

Parameter modifications will be saved into PC memory:

- press **Save** button to access **Computer SW Archive - Setting Files** page, **Setting File Name** pop-up appears
- input a valid name into **Description** field and press **Ok** button

REFERENCE

The source of reference signals for valves is preset as **Fieldbus** by factory default

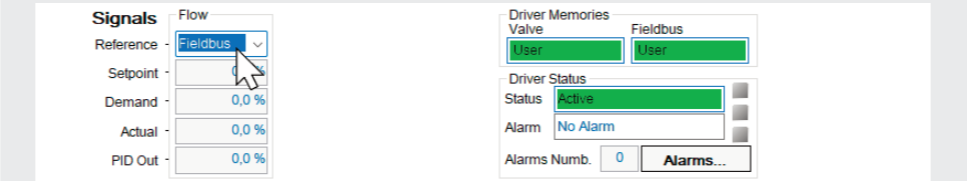

HINT ! - Wizard objects dictionary

Press **CTRL + H** on the PC keyboard to open the context help form
Move arrow on parameter (e.g. **Unit**) to display the objects dictionary information to access the parameter via fieldbus
If present **List**, press **→** to display values accepted by the parameter

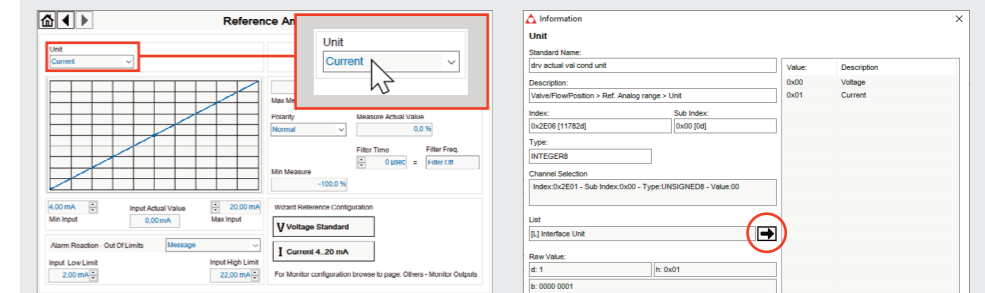

NOTE: alternatively right click on any parameter

TROUBLESHOOTING

- The valve does not follow the reference signal**
- valve is powered off, verify presence of 24 Vdc power supply
 - flow/pressure values exceeding the valve's performance limits, verify that hydraulic operating conditions are in compliance with the valve's characteristics
 - spool sticking, contact Atos service center

PC software parameters modifications are lost when valve is switched off
• parameter store operation was not performed, check store procedure – see STEP 3, section 3.4

PC software parameters modifications have no effect on the valve
• valve is OFF LINE, check connection procedure – see STEP 3, section 3.1

- After the modifications of PC software parameters the valve does not work properly**
- restore valve factory parameters using 'Load Factory Set' button, located in 'Driver - Memory Save' window:
 - during restore, the current to the solenoid(s) will be temporarily switched to off!
 - factory parameters will be applied at next driver restart or after power off-on sequence!