

PROPORTIONAL PRESSURE RELIEF AND REDUCING VALVES

Valve model: RZMO-AES RZGO-AES AGMZO-AES AGRCZO-AES

Driver model: E-RI-AES

IDENTIFICATION

Valve identification plates and label

Valve name plate : M
1 : valve code
2 : valve matrix code
3 : valve hydraulic symbol

Pilot valve name plate : N
4 : pilot valve code
5 : pilot valve matrix code
6 : pilot hydraulic symbol

Driver label : L
7 : driver code
8 : driver serial number
9 : factory firmware version

INSTALLATION TOOLS ACCORDING TO VALVE MODEL- not included

Fastening bolts	Wrenches	Screwdriver	Main connectors	Fieldbus connectors
socket head screws	wrenches and for fastening bolts and mechanical pilot relief	screwdriver for air bleeding	std./Q /Z	BC BP EH
	see STEP 1 and STEP 3		7 pin metallic / 12 pin metallic	5 pin metallic / 5 pin metallic / 4 pin metallic
			see STEP 2.1	see STEP 2.2

PROGRAMMING TOOLS - not included

Software	USB connection KIT	OR	Bluetooth connection KIT
E-SW-* programming software	Cable Isolator		Cable Adapter
	E-C-SB-USB/M12 E-A-SB-USB/OPT		E-C-SB-M12/BTH E-A-SB-USB/BTH

PROGRAMMING SOFTWARE

The software is available in different versions according to the driver's options:

Software	supports	NP (USB)	IL (IO-Link)	PS (Serial)	IR (Infrared)
AE-SW-BASIC					
E-SW-FIELDBUS		BC (CANopen)	BP (PROFIBUS DP)	EH (EtherCAT)	EP (PROFINET RT/IRT)
E-SW-/PQ		valves with SP, SF, SL alternated P/Q control			

E-SW-FIELDBUS supports also valves without fieldbus communication; E-SW-/PQ supports also valves without P/Q control

REMARK Atos software is designed for Windows based operative systems - Windows XP SP3 or later

DOWNLOAD AREA

Perform the registration at www.atos.com/en-it/login by filling the form. In MyAtos area, perform login with personal username and password and then press the **Download area electronics** button

Free version of E-SW-BASIC can be downloaded and used by the "FREE Activation Code"

The software remains active for 10 days from the installation date and then it stops until the user inputs the Activation Code

RELATED DOCUMENTATION - www.atos.com - section Catalog on-line

FS900 Operating and maintenance information - tech. table	STARTUP E-SW-FIELDBUS Software startup guide
FS007 RZMO-010 pressure relief, direct - tech. table	STARTUP BLUETOOTH Bluetooth adapter startup guide
FS015 RZGO-010 pressure reducing, direct - tech. table	E-MAN-RI-AES AES - driver operating manual
FS035 AGMZO pressure relief, two stage - tech. table	E-MAN-S-BC CANopen protocol programming manual
FS050 AGRCZO pressure reducing, two stage - tech. table	E-MAN-S-BP PROFIBUS DP protocol programming manual
FS065 RZMO-030 pressure relief, piloted - tech. table	E-MAN-S-EH EtherCAT protocol programming manual
FS070 RZGO-033 pressure reducing, piloted - tech. table	
P005 Mounting surface - tech. table	
GS500 Programming tools - tech. table	
GS510 Fieldbus - tech. table	
K800 Electric and electronic connectors - tech. table	

ATTENTION !

The purpose of this quickstart guide is show a logical sequence of basic operations. This guide does not cover all details or variants of Atos valves. All operations described in this document should be performed only by qualified personnel. Operations and images could be subject to change without notice. For further information please refer to related documentation.

CONTACT US

Atos spa - Italy - 21018 Sesto Calende www.atos.com support@atos.com

PRODUCTS OVERVIEW

INSTALLATION			PROGRAMMING
STEP 1	STEP 2	STEP 3	STEP 4
MECHANICAL	ELECTRICAL	HYDRAULICS	SOFTWARE

STEP 1 MECHANICAL

In case of first commissioning, before the valve installation the whole system must be correctly flushed to grant the required cleanliness level

During the flushing operation use on-off or by-pass valves in place of the proportional valve

- remove protection pad P1 located on the valve bottom face only immediately before installation (do not remove connectors caps)
- check the presence and correct positioning of the seals on valve ports
- verify that valve mounting surface is clean and free from damages or burrs
- verify the correct valve orientation according to the pattern of the relevant mounting interface
- lock the fastening bolts respecting below sequence and tightening torque according to valve model

Valve Model	Mounting surface layout	Fastening bolts	Tightening torque
RZMO-AES / RZGO-AES	4401-03-02-0-05 (RZMO without A and B ports) Valve size ISO 4401: 06	n°4 M5x50 class:12.9	8 Nm
AGMZO-AES-10	6264-06-09-1-97 Valve size ISO 6264: 10	n°4 M12x35 class:12.9	125 Nm
AGMZO-AES-20	6264-08-13-1-97 Valve size ISO 6264: 20	n°4 M16x50 class:12.9	300 Nm
AGMZO-AES-32	6264-10-17-1-97 Valve size ISO 6264: 32	n°4 M20x60 class:12.9	600 Nm
AGRCZO-AES-10	5781-06-07-0-00 Valve size ISO 5781: 10	n°4 M10x45 class:12.9	70 Nm
AGRCZO-AES-20	5781-08-10-0-00 Valve size ISO 5781: 20	n°4 M10x45 class:12.9	70 Nm

STEP 2 ELECTRICAL

This section considers the different valves options, illustrating the multiple variants of the available electrical connections. The electrical connections have to be wired according to the selected valve code

2.1 MAIN CONNECTOR

- Remove main connector cap P2
- Select main connector according to valve code and proceed with wirings operations
- Connect the valve to the system

WARNING: remove power supply before any electrical or wiring operations

WARNING: a safety fuse is required in series to driver power supply - 2.5 A time lag fuse

Standard		/Z option	
A	V+ (power supply 24Voc)	1	V+ (power supply 24Voc)
B	V0 (power supply 0Voc)	2	V0 (power supply 0Voc)
C	AGND	3	ENABLE (input 24Voc)
D	INPUT+ (0 ÷ 10Voc / 4 ÷ 20mA)	4	INPUT+ (0 ÷ 10Voc / 4 ÷ 20mA)
E	INPUT- (0 ÷ 10Voc / 4 ÷ 20mA)	5	INPUT- (0 ÷ 10Voc / 4 ÷ 20mA)
F	MONITOR (0 ÷ 5Voc 1V=1A)	6	MONITOR (0 ÷ 5Voc 1V=1A)
G	EARTH	7	NC
		8	NC
		9	VL+ (logic power supply 24Voc)
		10	VLO (logic power supply 0Voc)
		11	FAULT (output 24Voc)
		PE	EARTH

/Q option	
A	V+ (power supply 24Voc)
B	V0 (power supply 0Voc)
C	ENABLE (input 24Voc)
D	INPUT+ (0 ÷ 10Voc / 4 ÷ 20mA)
E	INPUT- (0 ÷ 10Voc / 4 ÷ 20mA)
F	MONITOR (0 ÷ 5Voc 1V=1A)
G	EARTH

2.2 FIELDBUS CONNECTORS

- Remove fieldbus connectors caps P3
- Select fieldbus connectors according to valve code and proceed with wirings operations
- Connect the valve to the fieldbus network. For information about T connectors and fieldbus terminators see GS500

BC		BP		EH	
1	CAN_SHLD Shield	1	+5V Termination supply signal	1	TX+ Transmitter
2	not used	2	LINE-A Bus line (high)	2	RX- Receiver
3	CAN_GND Signal zero data line	3	DGND Data line - termination signal zero	3	TX- Transmitter
4	CAN_H Bus line (high)	4	LINE-B Bus line (low)	4	RX- Receiver
5	CAN_L Bus line (low)	5	SHIELD	housing	SHIELD

NOTE: the use of above metallic connectors is strongly recommended in order to fulfill EMC requirements

ELECTRICAL WIRING EXAMPLES

MAIN CONNECTOR - VOLTAGE

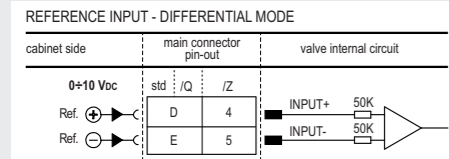

REFERENCE INPUT - COMMON MODE

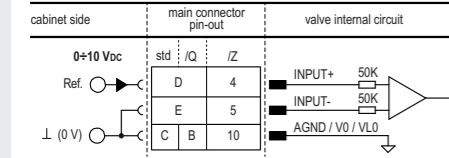

MAIN CONNECTOR - MONITORS VOLTAGE ONLY

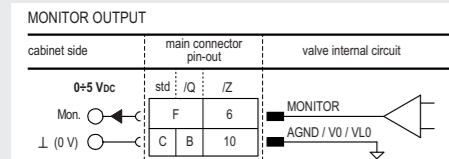

STEP 3 HYDRAULICS

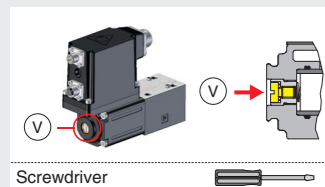

Air bleeding:

- release 2 or 3 turns the air bleed screw **V**
- cycle the valve at low pressure until the oil leaking from the **V** port is exempted from air bubbles
- lock the air bleed screw **V**

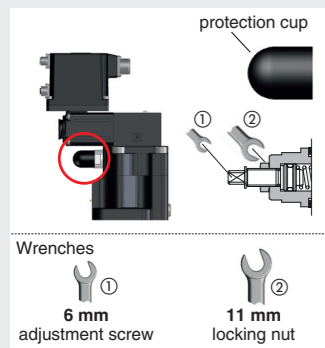

Mechanical pressure limiter setting – only AGMZ0 and AGRCZ0 with /P option

- For safety reasons the factory setting of the mechanical pressure limiter is fully unloaded (min pressure). At the first commissioning it must be set at a value lightly higher than the max pressure regulated with the proportional control, proceeding as follow:
- apply the max reference input signal to the valve's driver. The system pressure will not increase until the mechanical pressure limiter remains unloaded
 - release the locknut ②, turn clockwise the adjustment screw ① until the system pressure will increase up to a stable value corresponding to the pressure set-point at max reference input signal
 - turn clockwise the adjustment screw ① of additional 1 or 2 turns to ensure that the mechanical pressure limiter remains closed during the proportional valve working, then tighten the locknut ②

Consult tech table **FS900** for general guidelines about component's commissioning

HINT ! - Wizard objects dictionary - only for BC, BP, EH

Press **CTRL + H** on the PC keyboard to open the context help form

Move arrow on parameter (e.g. **Unit**) to display the objects dictionary information to access the parameter via fieldbus

If present **List**, press **→** to display values accepted by the parameter

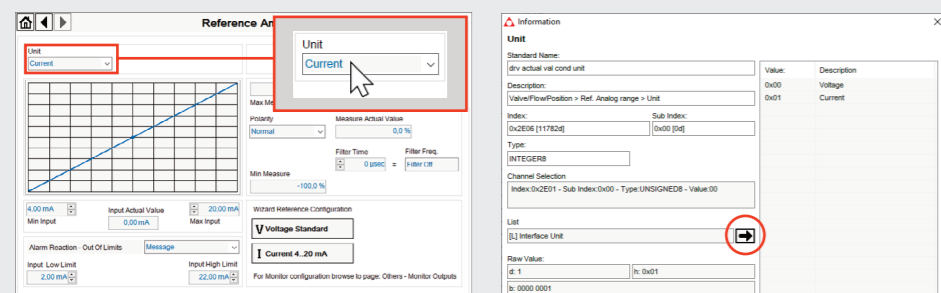

NOTE: alternatively right click on any parameter



STEP 4 SOFTWARE

REMARK proportional valves with integral electronics are factory preset with default parameters, only few programming operations are mandatory for setup the network parameters and the source of reference signals

Valve programming can be performed through E-SW software or via fieldbus

PROGRAMMING				PC
4.1	4.2	4.3	4.4	4.5
CONNECTION	FIELDBUS	REFERENCES	STORE	BACK UP

4.1 CONNECTION

- In order to access valve parameterization:
 - Install E-SW software on PC
 - Insert main connector to the valve and power on with 24Vdc

- Remove USB plastic protection cap **P4** and connect valve to the PC as shown below

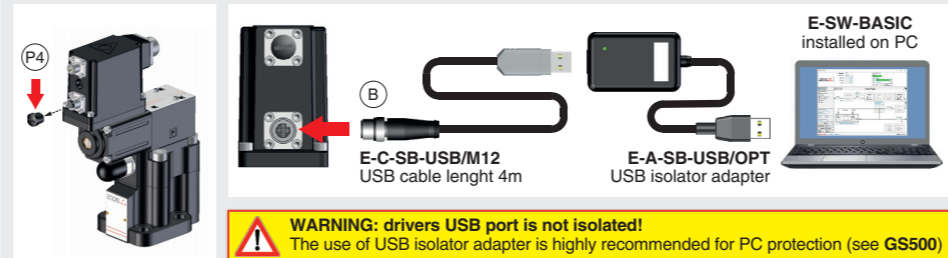

- Launch the software using E-SW icon:
 - software does NOT detect valid connection** communication is not established, please follow wizard procedure
 - software detects valid connection** communication automatically established - valve is **ON-LINE** see

- Press buttons according the below sequence:

- ON-LINE - Recommended**
Wizard procedure for standard connection
- CONNECT TO BC, BP, EH, EW, EI, EP**

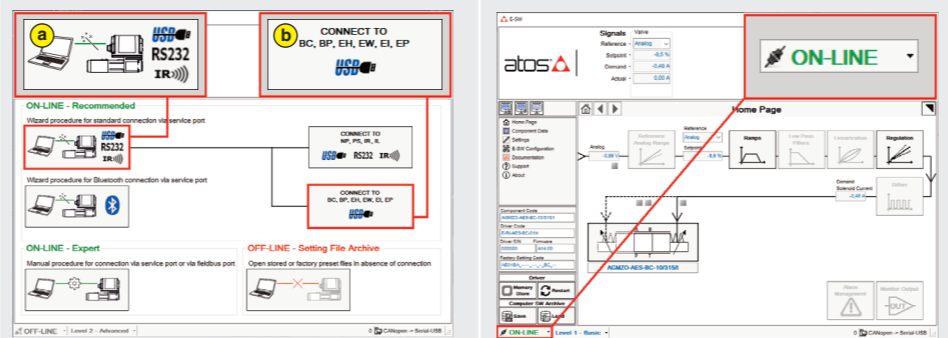

NOTE: Bluetooth adapter available!
For more info please refer to **STARTUP BLUETOOTH** guide

REMARK: once removed the USB cable E-C-SB-USB/M12, screw the plastic protection cap **P4** applying the correct tightening torque, in order to preserve valve's IP protection characteristics

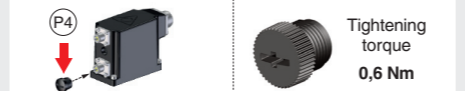

4.2 FIELDBUS - Network Management

Node, Station Alias, IP Address, Baudrate, etc... can be set through:

- Machine central unit (master)** - please refer to E-MAN-S-** fieldbus protocol programming manual
- E-SW software**
 - switch to **Level 2 - Advanced** and browse to **Network Management - Configuration** to change below default settings:

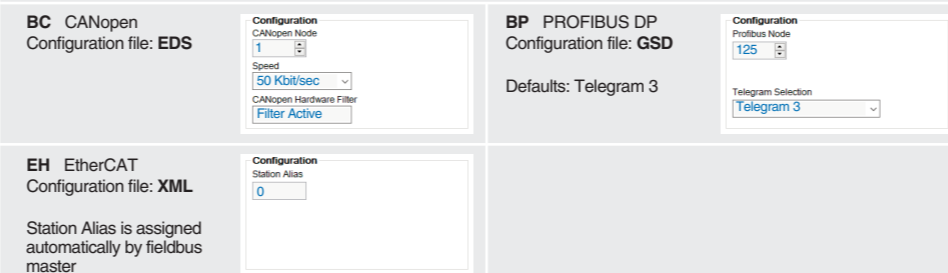

- press **Memory Store** button and in **Fieldbus Parameters** press **Store User** button to save new setting into the driver (see 4.4)
- network configuration settings will be applied at next driver power-on or pressing the **Restart** button

NOTE: configuration files are available in USB memory stick of the software or in MyAtos area - www.atos.com

4.3 REFERENCES

The source of reference signals for valves with fieldbus:

- is preset as **Analog** by factory default
- can be managed through machine control unit by setting the source from **Analog** to **Fieldbus**

In Valve - Reference select **Fieldbus**

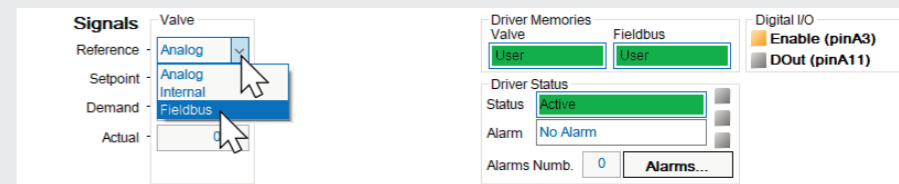

4.4 STORE

Parameters modifications will be stored into driver permanent memory:

- press **Memory Store** button to access **Driver - Memory Store** window
- press **Store User** buttons to store **Valve Parameters** or **Fieldbus Parameters**

WARNING: During valve or fieldbus parameters storing operations, the driver automatically shuts down the solenoid power supply for a short time. Do not perform any storing commands while the system is working.

4.5 BACK UP

Parameter modifications will be saved into PC memory:

- press **Save** button to access **Computer SW Archive - Setting Files** page, **Setting File Name** pop-up appears
- input a valid name into **Description** field and press **Ok** button

TROUBLESHOOTING

Valve vibration or noise

- presence of air in the solenoid; perform air bleeding procedure – see STEP 3
- dither frequency too low; increase value of the frequency – please refer to E-MAN-RI-AES operating manual

The valve does not follow the reference signal

- valve is powered off, verify presence of 24 Vdc power supply
- valve is disabled, verify presence of 24 Vdc on enable pin - only for /Q and /Z options
- the mechanical pressure limiter interferes with the regulation (AGMZ0 and AGRCZ0 with /P option) – check the pressure limiter setting
- spool sticking (RZMO-030 and RZGO-033) – contact Atos service center
- wrong pilot/drain configuration (AGMZ0) – check if the pilot/drain configuration of the valve corresponds to the effective system layout

Software parameters modifications are lost when valve is switched off

- parameter store operation was not performed, check store procedure – see STEP 4, section 4.4

Software parameters modifications have no effect on the valve

- valve is OFF LINE, check connection procedure – see STEP 4, section 4.1

After the modifications of software parameters the valve does not work properly

- restore valve factory parameters using 'Restore Factory' button, located in 'Driver - Memory Store' window:
 - during restore, the current to the solenoid(s) will be temporarily switched to off!
 - factory parameters will be applied at next driver restart or after power off-on sequence!