

Digital electronic drives for SSP servopumps

fieldbus, smart start-up, smart maintenance



SMART START-UP



SMART TUNING



MULTIPLE AXIS



SMART MAINTENANCE



D-MP-T-SP-BC-022/K

① Drive power supply - input	⑤ Safe Torque Off (STO)
② Servomotor power supply - output	⑥ CANopen
③ Serial RS485 communication port	⑦ PROFIBUS DP, EtherCAT or PROFINET
④ IN/OUT signals	⑧ Servomotor resolver



D-MP

Electronic drive exploits the modern technology of servo drives to accurately control pressure and flow in hydraulic systems through Smart Servopumps (SSP).

Atos PC software allows to customize the SSP configuration and via the Smart Start-up function guides the user step by step during the commissioning phases.

Multiple axis function allows to manage customized settings for up to 4 axes.

Smart Maintenance provides information on health condition of SSP and allows to plan in advance the replacement of worn components, maximizing productivity and minimizing maintenance costs.

For more info please refer to AS050.

General Features:

- DB9 serial port RS485 always present
- Fast plug-in connectors input/output for CANopen
- DB9 connector for PROFIBUS DP
- RJ45 connectors input/output for EtherCAT, PROFINET IO RT/IRT
- DB15 connector for servomotor resolver always present
- Fast plug-in connector for STO always present
- Ambient temperature range: -10 ÷ +50 °C
- IP20 protection degree
- CE mark according to LVD and EMC directive

Software Features:

- Intuitive graphic interface
- Smart Maintenance
- Smart Start-up
- Multiple axis
- Smart tuning
- Setting of SSP functional parameters
- Complete diagnostics
- Internal oscilloscope function

1 MODEL CODE

D-MP	-	T-SP	-	BC	-	022	/	K	*
Electronic drive in wall mounting format								Series number	

Control mode:

T-SP = high performances P/Q control

STO function, see section 12 :

K = Safe Torque Off (STO) - always present

Fieldbus interface, serial port RS485 always present:

- NP = not present
- BC = CANopen
- BP = PROFIBUS DP
- EH = EtherCAT
- EP = PROFINET RT/IRT

Rated current [Arms], see section 6 :

- | | | |
|-------------------|---------------------|--------------------|
| 022 = 22 A | 060 = 57,5 A | 140 = 140 A |
| 032 = 32 A | 090 = 87 A | 165 = 165 A |
| 046 = 46 A | 100 = 100 A | 210 = 210 A |

2 BLOCK DIAGRAM EXAMPLE

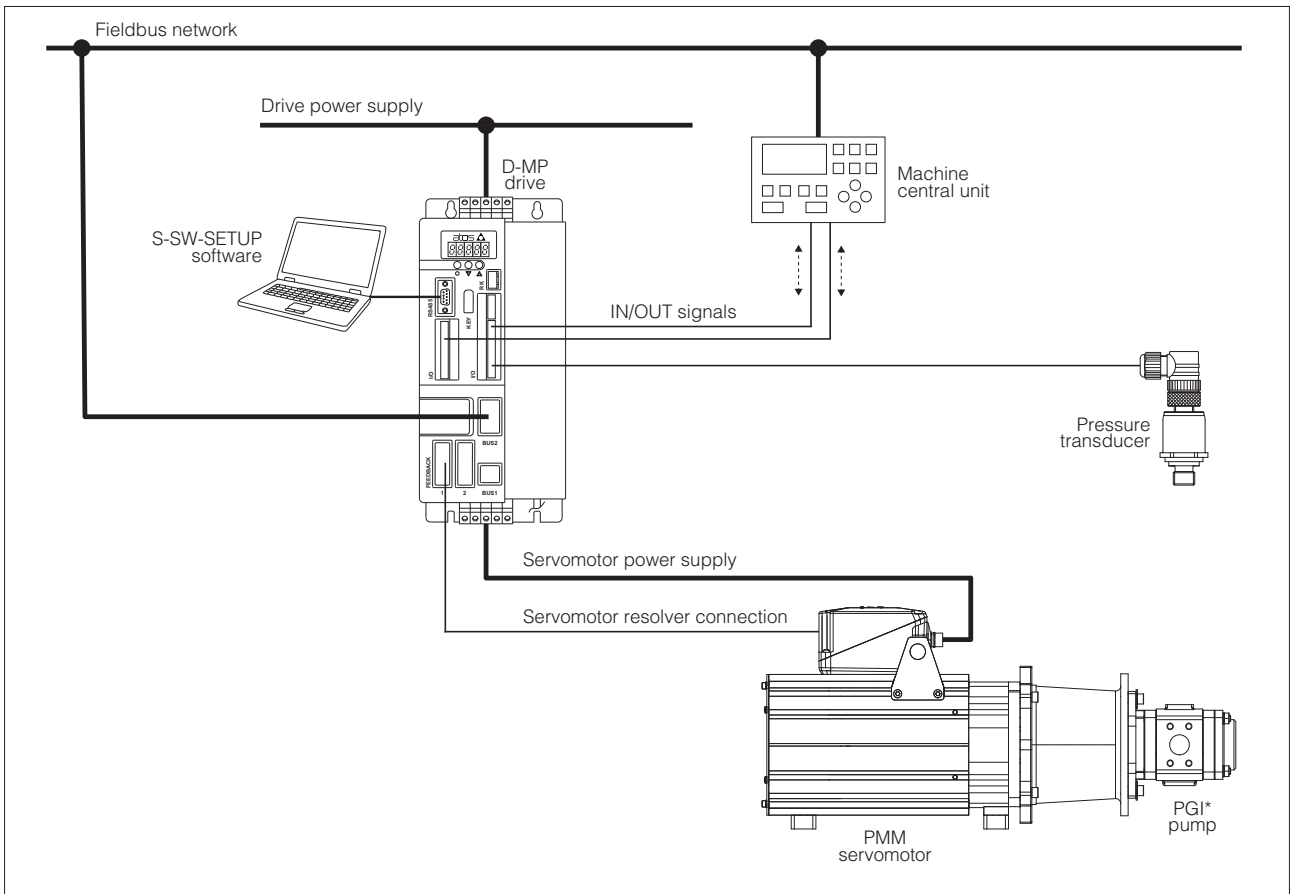

3 DRIVE SETTINGS AND PROGRAMMING TOOLS - see tech. table AS800

Drive functional parameters and configurations, can be easily set and optimized using Atos S-SW-SETUP programming software connected via serial port RS485 to the drive. For fieldbus versions, the software permits drive parameterization through serial port RS485 also if the drive is connected to the central machine unit via fieldbus.

S-SW-SETUP and permits to have many features so as Smart Start-up, Multiple axis and Smart tuning for an easy and rapid commissioning. For more info refer to **AS050**.

S-SW-SETUP support:

NP (Serial RS485)	
BC (CANopen)	EH (EtherCAT)
BP (PROFIBUS DP)	EP (PROFINET)

Notes:

free download of S-SW-SETUP in MyAtos area at www.atos.com
 for detailed descriptions of settings, wirings and installation procedures, please refer to the user manual included in the S-SW-SETUP

Serial port RS485 connection

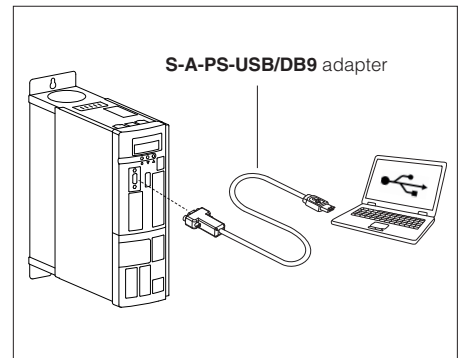

4 FIELDBUS - see tech. table GS510

Fieldbus allows drive direct communication with machine control unit for digital reference, drive diagnostics and settings. These execution allow to operate the drive through fieldbus or analog signals available on the connectors.

5 GENERAL CHARACTERISTICS

Assembly position	Wall mounting
Ambient temperature range	-10 ÷ 50°C ; the maximum ambient temperature of D-MP is 50°C - a derating is necessary
Altitude	0 ÷ 1000 m; current derating for higher altitudes
Humidity	5÷ 85%
Vibration	1g (57 Hz ≤ frequency ≤ 150Hz)
Cooling	Fan
Compliance	CE according to Low Voltage Directive (LVD) 2014/35/EU and to EMC directive 2014/30/EU RoHS Directive 2011/65/EU as last update by 2015/863/EU

6 ELECTRICAL CHARACTERISTICS

Drive type	022	032	046	060	090	100	140	165	210	
Rated current [A]	22	32	46	57.5	87	100	140	165	210	
Overload current (1) [A]	44	64	92	115	174	200	280	330	420	
Rated power [kW]	11	15	22	30	45	55	75	90	110	
Rated IN voltage [V]	200 V -10% ÷ 480 V +10% @ 45 ÷ 65 Hz				400 V -10% ÷ 480 V +10% @ 45 ÷ 65 Hz					
DC Bus voltage [V]	280 V -10% ÷ 600 V +10%				280 V -10% ÷ 640 V +10%					
PWM frequency (2) [kHz]	1 ÷ 15							1 ÷ 10		
Network type	Grounded (TT, TN) corner earthed or not earthed, ungrounded (IT)									
Max shorts circuit current [A]	5000				10000					
Overvoltage category	3									
Protective class	I									
Thermal braking current [A]	15	25	45	45	89	109	149	179	219	
Peak current [A]	30	50	85	85	138	138	188	225	275	
Braking voltage [V]	780									
24VDC input power supply	24 V _{DC} ±10% @ max 1,0 A for drives type 022, 090, 100, 140, 165, 210 24 V _{DC} ±10% @ max 1,3 A for drives type 032 24 V _{DC} ±10% @ max 1,8 A for drives type 046, 060									
24VDC output power supply	24 V _{DC} ±10% @ max 500 mA - only for drives type 090, 100, 140, 165, 210									
Digital inputs	24 V _{DC} ±10% @ max 10 mA									
Digital outputs - fast contact	30 V _{DC} @ max 60 mA (max 5 kHz)									
Digital outputs - relay contact	30 V _{DC} @ max 1 A									
Analog inputs	±10 V @ max 0,5 mA or 4 ÷ 20 mA (settable with specific dip-switch - see user manual)									
Analog outputs	±10 V @ max 2 mA									
Pressure transducer power supply	+24 V _{DC} @ max 100 mA (E-ATR-8 see tech table GS465)									
Protection degree to DIN EN60529	IP20									
Analog reference resolution	12 bit									
Speed control mode	Field-Oriented Control									
Braking resistance	External (see tech table AS810)									
Filter	External (see tech table AS810)									
Reactance	External - recommended for high power (> 45kW) (see tech table AS810)									
Communication interface	Serial Atos ASCII coding	CANopen EN50325-4 + DS408	PROFIBUS DP EN50170-2/IEC61158	EtherCAT, PROFINET IO RT / IRT EC 61158						
Communication physical layer	insulated RS485	optical insulated CAN ISO11898	optical insulated RS485	Fast Ethernet, insulated 100 Base TX						
Recommended wiring cable for logic and 24V _{DC} power supply	LiYCY shielded cables - max conductor size: 1,5 mm ² 1,5 mm ² max 30 m for 24V _{DC} power supply - 0,5 mm ² max 30 m for logic Notes: for pressure transducer wiring cable please consult the transducer datasheet									
Recommended wiring cable for drive and servomotor power supply	see section 13									

(1) 200% overload for maximum 3s and 155% for 30s

(2) Default is 5 kHz

7 WIRING BLOCK DIAGRAM

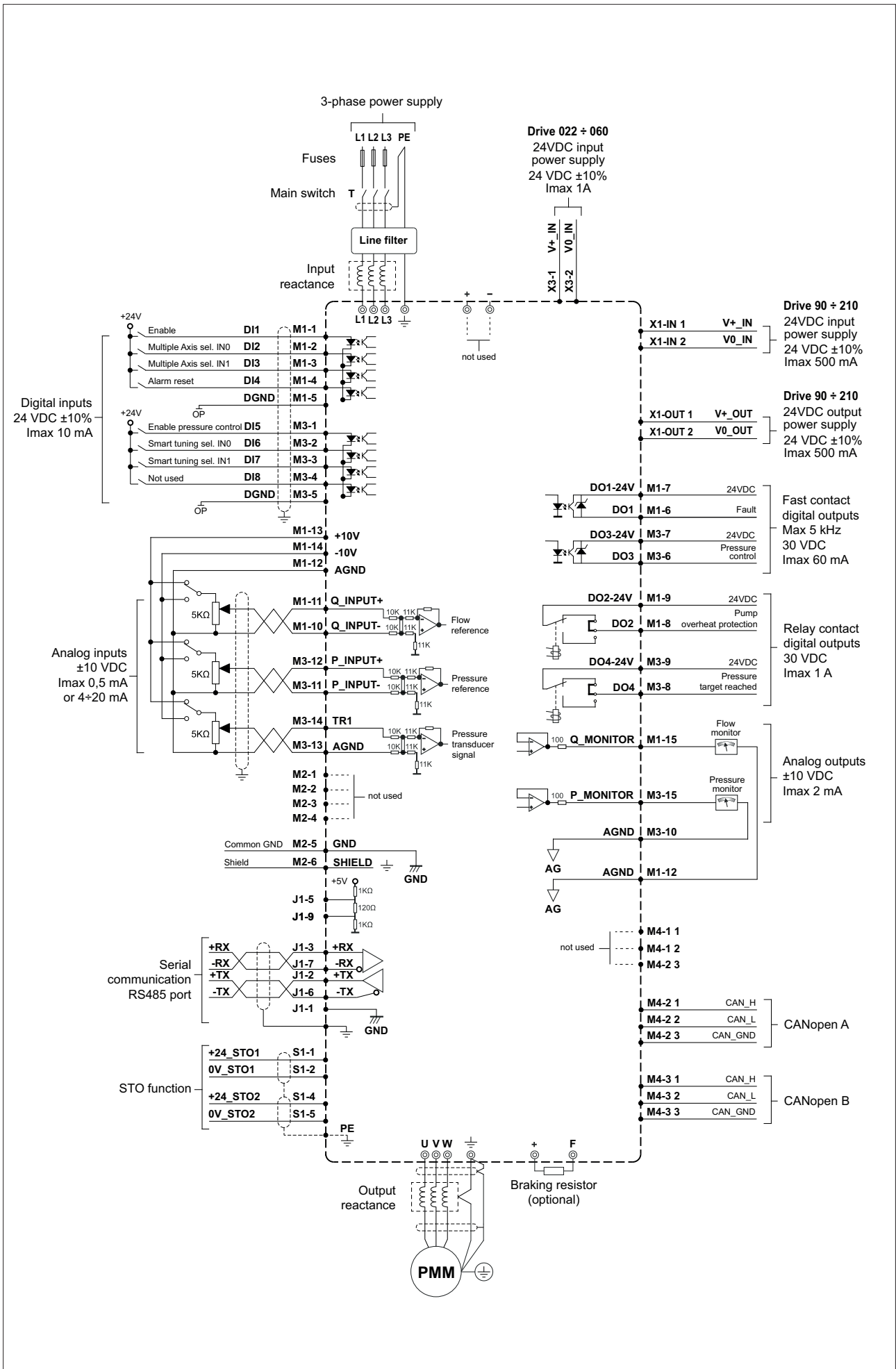

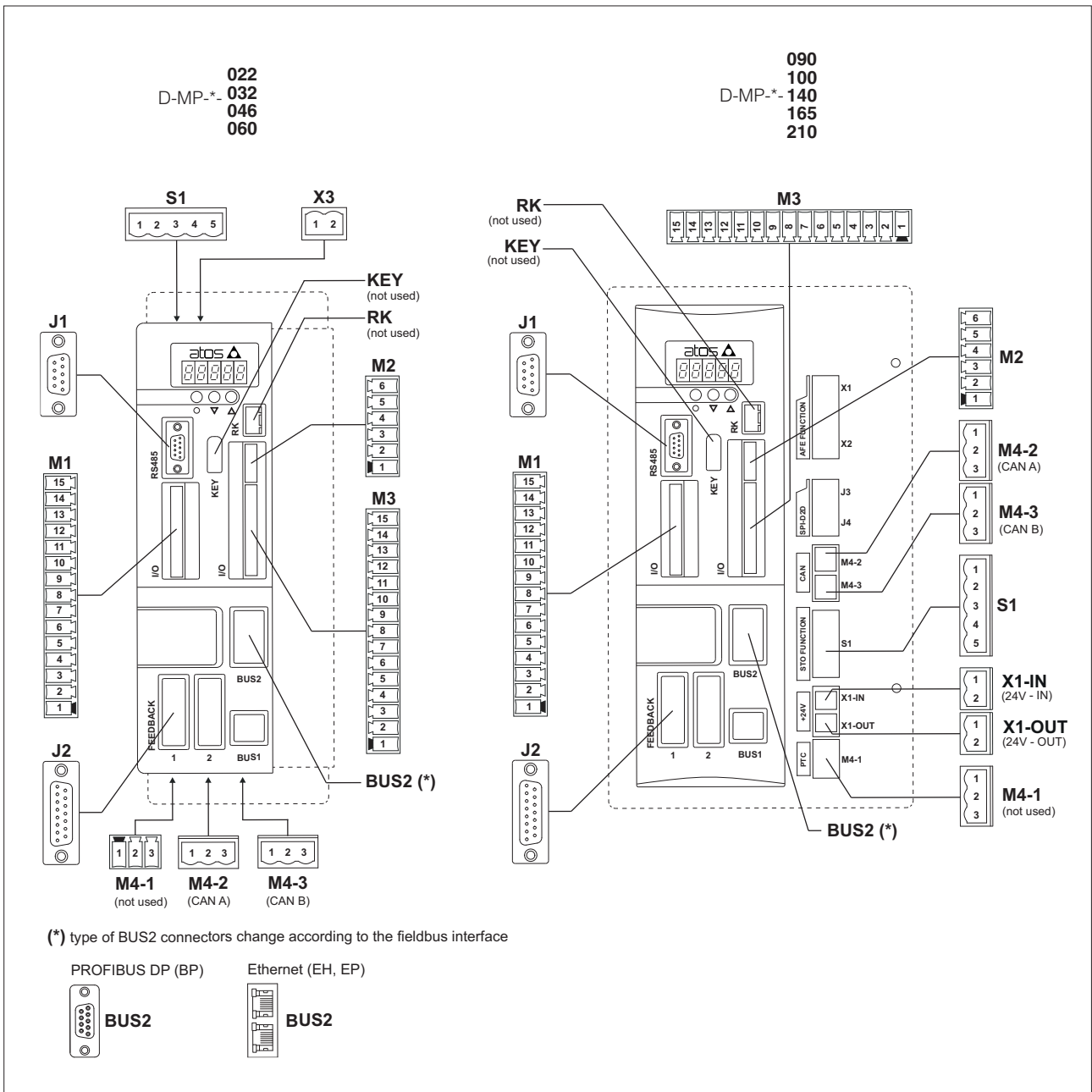

Connectors	Description	See
M1	IN/OUT analog and digital signals	8.1
M3	IN/OUT analog and digital signals - P/Q control	8.2
M2	Not used - available only for gnd and shield connections	8.3
X3	24VDC input power supply - only for 022, 032, 046, 060	8.4
X1-IN	24VDC input power supply - only for 090, 100, 140, 165, 210	8.5
X1-OUT	24VDC output power supply - only for 090, 100, 140, 165, 210	8.6
S1	Safe Torque Off (STO function)	8.7
J2	Servomotor resolver	8.8
J1	Serial RS485 communication port	8.10
M4-1	Not used - Servomotor thermal sensor	-
M4-2	CANopen interface A (always present - to be used only for the BC version)	8.11
M4-3	CANopen interface B (always present - to be used only for the BC version)	8.11
BUS2	Fieldbus optional boards - only for BP	8.12
	Fieldbus optional boards - only for EH, EP	8.13
KEY	Not used	-
RK	Not used	-

8.1 M1 connector - IN/OUT digital and analog signals

CONNECTOR	PIN	SIGNAL	TECHNICAL SPECIFICATIONS	NOTES
	1	DI1	Enable (24 Vdc) or disable (0 Vdc), referred to DGND	Input - on/off signal
	2	DI2	Multiple axis selection IN0, referred to DGND	Input - on/off signal
	3	DI3	Multiple axis selection IN1, referred to DGND	Input - on/off signal
	4	DI4	Alarm reset	Input - on/off signal
	5	DGND	Common gnd for digital input	Common gnd
	6	DO1 (1)	Fault (0 Vdc) or normal working (24 Vdc), referred to DO1-24V	Output - on/off signal Software selectable
	7	DO1-24V	DO1 power supply 24 Vdc	Input - power supply
	8	DO2 (2)	For SSP without /D option: STO test suggested (24 Vdc) or not suggested (0 Vdc), referred to DO2-24V For SSP with /D option: Smart cooling active (24 Vdc) or not active (0 Vdc), referred to DO2-24V	Output - on/off signal Software selectable
	9	DO2-24V	DO2 power supply 24 Vdc	Input - power supply
	10	Q_INPUT-	Negative flow reference input signal for Q_INPUT+	Input - analog signal
	11	Q_INPUT+	Flow reference input signal: ± 10 Vdc / $4 \div 20$ mA maximum range Default is $0 \div 10$ Vdc	Input - analog signal Dip-switch selectable
	12	AGND	Common gnd for Q_MONITOR and stabilized power supply	Common gnd
	13	+10V	Stabilized power supply +10V - Current: max 10 mA	Output power supply
	14	-10V	Stabilized power supply -10V - Current: max 10 mA	Output power supply
	15	Q_MONITOR	Flow monitor output signal: ± 10 Vdc maximum range, referred to AGND Default is $0 \div 10$ Vdc (10V = 3276,7 rpm)	Output - analog signal Software selectable

(1) Digital output with fast contact (2) Digital output with relay contact

8.2 M3 connector - IN/OUT digital and analog signals - P/Q control connections

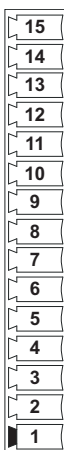
CONNECTOR	PIN	SIGNAL	TECHNICAL SPECIFICATIONS	NOTES
	1	DI5	Enable (24 Vdc) or disable (0 Vdc) P/Q control, referred to DGND	Input - on/off signal
	2	DI6	Pressure smart tuning selection IN0, referred to DGND	Input - on/off signal
	3	DI7	Pressure smart tuning selection IN1, referred to DGND	Input - on/off signal
	4	DI8	(not used)	Input - on/off signal
	5	DGND	Common gnd for digital input	Common gnd
	6	DO3 (1)	Smart maintenance alert (24 Vdc) or not alert (0 Vdc), referred to DO3-24V	Output - on/off signal Software selectable
	7	DO3-24V	DO3 power supply 24 Vdc	Input - power supply
	8	DO4 (2)	STO corrupted (24 Vdc) or not corrupted (0 Vdc), referred to DO4-24V	Output - on/off signal Software selectable
	9	DO4-24V	DO4 power supply 24 Vdc	Input - power supply
	10	AGND	Common gnd for P_MONITOR	Common gnd
	11	P_INPUT-	Negative pressure reference input signal for P_INPUT+	Input - analog signal
	12	P_INPUT+	Pressure reference input signal: ± 10 Vdc / $4 \div 20$ mA maximum range Default is $0 \div 10$ Vdc	Input - analog signal Dip-switch selectable
	13	AGND	Common gnd for transducer signal	Common gnd
	14	TR1	Signal pressure transducer: ± 10 Vdc / $4 \div 20$ mA maximum range Default is $0 \div 10$ Vdc	Input - analog signal Dip-switch selectable
	15	P_MONITOR	Pressure monitor output signal: ± 10 Vdc maximum range, referred to AGND Default is $0 \div 10$ Vdc (10V = 819,2 bar)	Output - analog signal Software selectable

(1) Digital output with fast contact (2) Digital output with relay contact

Remote pressure transducer connections - examples

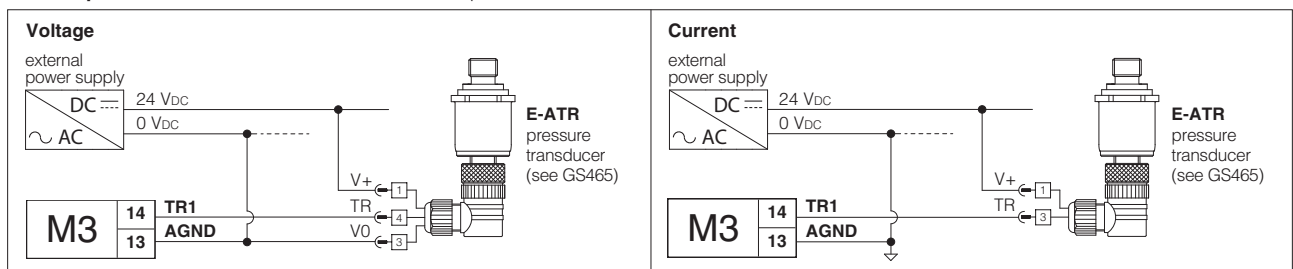

8.3 M2 connector - not used - available only for common GND and SHIELD connection

CONNECTOR	PIN	SIGNAL	TECHNICAL SPECIFICATIONS	NOTES
	1	NC	-	Do not connect
	2	NC	-	Do not connect
	3	NC	-	Do not connect
	4	NC	-	Do not connect
	5	GND	Common gnd	
	6	SHIELD	Shield	

8.4 X3 connector - 24VDC input power supply - only for drives type **022 ÷ 060**

CONNECTOR	PIN	SIGNAL	TECHNICAL SPECIFICATIONS	NOTES
	1	V+_IN	Power supply 24 Vdc	Input - power supply
	2	V0_IN	Power supply 0 Vdc	Gnd - power supply

8.5 X1-IN connector - 24VDC Input power supply - only for drives type **090 ÷ 210**

CONNECTOR	PIN	SIGNAL	TECHNICAL SPECIFICATIONS	NOTES
	1	V+_IN	Power supply 24 Vdc	Input - power supply
	2	V0_IN	Power supply 0 Vdc	Gnd - power supply

8.6 X1-OUT connector - 24VDC output power supply - only for drives type **090 ÷ 210**

CONNECTOR	PIN	SIGNAL	TECHNICAL SPECIFICATIONS	NOTES
	1	V+_OUT	Power supply 24 Vdc	Output - power supply
	2	V0_OUT	Power supply 0 Vdc	Gnd - power supply

8.7 S1 connector - Safe Torque Off (STO)

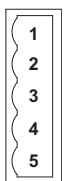
CONNECTOR	PIN	SIGNAL	TECHNICAL SPECIFICATIONS	NOTES
	1	+24V_STO1	Power supply for STO1 - first safety system channel	Input - power supply
	2	0V_STO1	Voltage: +24 Vdc ±10 % - Current: max 10 mA	Gnd - power supply
	3	NC	-	Do not connect
	4	+24V_STO2	Power supply for STO2 - second safety system channel	Input - power supply
	5	0V_STO2	Voltage: +24 Vdc ±10 % - Current: max 10 mA	Gnd - power supply

8.8 J2 connector - Servomotor resolver - DB15 - 15 pin

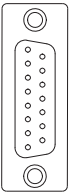
CONNECTOR	PIN	SIGNAL	TECHNICAL SPECIFICATIONS	NOTES
 <p>J2 female (drive view)</p>	1	Thermal sensor +	Servomotor thermal sensor - positive input (KTY or PT)	Input - analog signal
	2	Thermal sensor +	Servomotor thermal sensor - negative input (KTY or PT)	Input - analog signal
	3	RESEX+	-	
	4	RESEX-	-	
	5	COS+ , 1C/R	-	
	6	NC	-	Do not connect
	7	NC	-	Do not connect
	8	NC	-	Do not connect
	9	COS- , 1C/R	-	
	10	SIN+ , 1C/R	-	
	11	SIN- , 1C/R	-	
	12	NC	-	Do not connect
	13	NC	-	Do not connect
	14	NC	-	Do not connect
	15	NC	-	Do not connect

Servomotor resolver cable connection - example - see tech table AS810

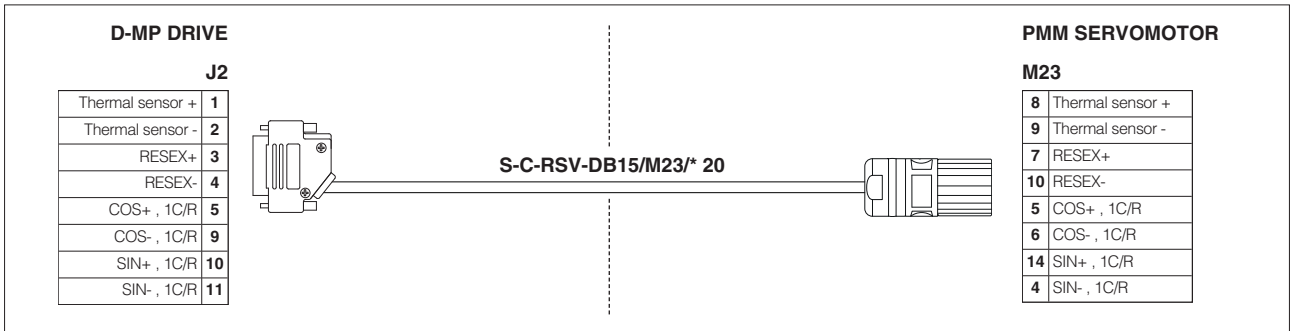

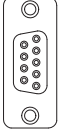

Note: for more information about PMM servomotor, please refer tech table AS400.

8.9 J1 connector - Serial RS485 communication port - DB9 - 9 pin

CONNECTOR	PIN	SIGNAL	TECHNICAL SPECIFICATIONS	NOTES
 <p>female (drive view)</p>	1	NC	-	Do not connect
	2	TX+	Transmitter	
	3	RX+	Receiver	
	4	NC	-	Do not connect
	5	NC	-	Do not connect
	6	TX-	Transmitter	
	7	RX-	Receiver	
	8	NC	-	Do not connect
	9	NC	-	Do not connect

8.10 M4-2 and M4-3 connectors - CANopen (BC) - always present (not use for NP, BP, EH, EP)

CONNECTOR	PIN	SIGNAL	TECHNICAL SPECIFICATIONS	NOTES
 <p>main</p>	1	CAN_HA	Bus line (high)	
	2	CAN_LA	Bus line (low)	
	3	CAN_GND	Signal zero data line	
	1	CAN_HB	Bus line (high)	
	2	CAN_LB	Bus line (low)	
	3	CAN_GND	Signal zero data line	

Note: on the board are present two dip-switch; one allows to terminate the fieldbus network while the other allows the simultaneous use of both connectors as input and output. For more information about setting dip-switch, please refer user manual.

8.11 BUS2 connector - PROFIBUS DP (BP)

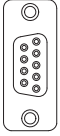
CONNECTOR	PIN	SIGNAL	TECHNICAL SPECIFICATIONS	NOTES
	1	SHIELD	Shield	
	2	NC	-	Do not connect
	3	LINE_B	Bus line (B)	
	4	DE	Control's signal for repeater	
	5	DGND	Data line and termination signal zero	
	6	+5V	Termination supply signal	
	7	NC	-	Do not connect
	8	LINE_A	Bus line (A)	
	9	NC	-	Do not connect

8.12 BUS2 connectors IN/OUT - Ethernet (EH, EP)

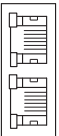
CONNECTOR	PIN	SIGNAL	TECHNICAL SPECIFICATIONS	NOTES
	1	TX+	Transmitter (white/orange)	
	2	RX+	Receiver (orange)	
	3	TX-	Transmitter (white/green)	
	4	NC	-	Do not connect
	5	NC	-	Do not connect
	6	RX-	Receiver (green)	
	7	NC	-	Do not connect
	8	NC	-	Do not connect

Note: perform the cables connection following the IN and OUT indications

9 DRIVE AND SERVOMOTOR POWER CONNECTIONS

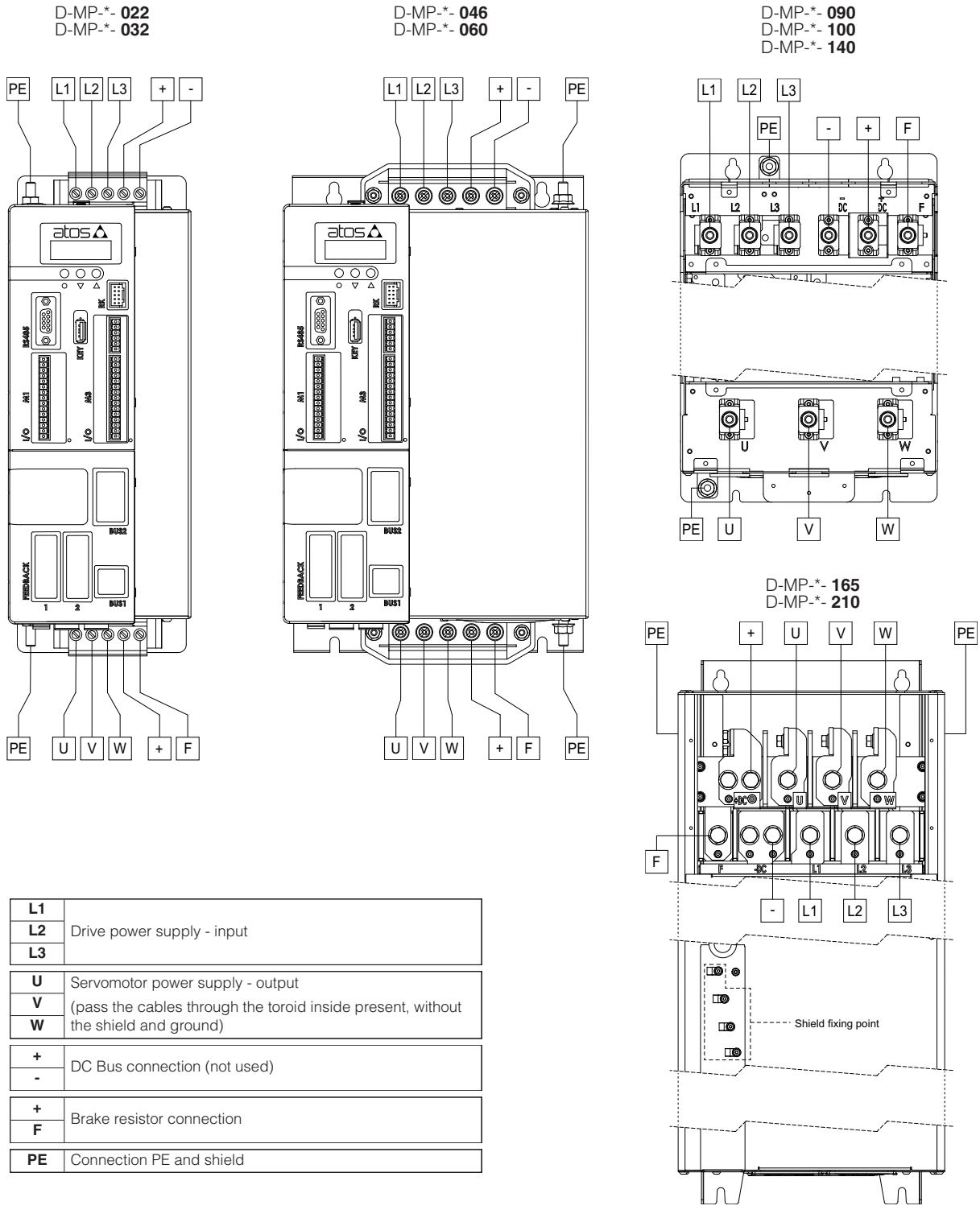

10 DISPLAY

On the drive front panel is available a numeric display to view the drive status: run or stop.

Note: the 3 keys, ● (S selection), ▼ (- decrease), ▲ (+ increase) are not used

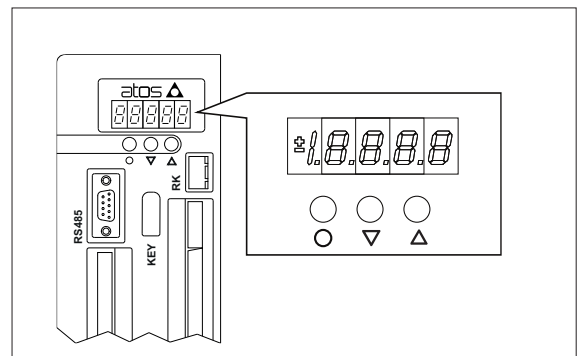

11 POWER SUPPLY AND SIGNALS SPECIFICATIONS

Atos digital drives are CE marked according to the applicable directives (e.g. Immunity and Emission EMC Directive). Installation, wirings and start-up procedures must be performed according to the general prescriptions shown in tech table **AS050** and in the user manuals included in the S-SW-SETUP programming software. Generic electrical output signals of the drive (e.g. fault or monitor signals) must not be directly used to activate safety functions, like to switch-ON/OFF the machine's safety components, as prescribed by the European standards (Safety requirements of fluid technology systems and components-hydraulics, ISO 4413).

11.1 Drive power supply (L1, L2, L3)

The drive must be connected to the main power supply through terminals L1, L2, L3 and with the ground cable connected to the PE stud (see section 9).

When connecting drives type 022 ÷ 060A to 3-phase supply mains we recommend using a 3-phase reactance (see tech table **AS810**).

For drives type 090 ÷ 210 the 3-phase input reactance is mandatory. The 3-phase reactance is used to reduce the current peaks on the diode bridge DB and the effective value of the current through the capacitors. It is also used to reduce interference from the supply line to the drive and from the drive to the line.

The drive must be wired steadily through appropriately sized cables (see section 13).

Notes: drives type 022 ÷ 060 feature a soft-start function built in the drive; the reactance can be omitted only for particular cases (in this case contact Atos technical office)



A correct installation to the main power supply is required according to IEC 61800-5-1



Ultra-fast fuses must be installed between the main power supply and the drive (see section 14)

11.2 Servomotor power supply (U, V, W)

The servomotor must be connected to terminals U, V, W and with the ground cable connected to the PE stud (see section 9).

For drives type 090 ÷ 140 pass the servomotor 3-phase through the present toroid inside, without shield and ground. Connect the servomotor by means of shielded or armored cables only and ground the shield on the converter side as well as on servomotor side. If shielded cables cannot be used, the servomotor cables should be placed in a metallic raceway connected to ground.

Atos recommends to use a 3-phase reactance between the drive and the servomotor; with cables longer than 50 meters, the reactance is mandatory (for more information please consult Atos technical office).

Any short circuit between U, V, W will cause the drive to shut down. If the interruption between the servomotor and the drive is obtained by means of electromagnetic switches (such as contactors, thermal relays and the like) ensure that the drive is disabled before cutting off the connection between the servomotor and the drive (in order not to damage the contactors).

The servomotor must be wired steadily through appropriately sized cables (see section 13).

11.3 24VDC input power supply (V+_IN and V0_IN)

Through the pins 1 and 2 of the X3 connector (for drives type 022 ÷ 060 see 8.4) or X1-IN connector (for drives type 090 ÷ 210 see 8.5) is possible to power the drive logic and servomotor sensor (mandatory for drives type 022 ÷ 060 no self powered).

The drives type 090 ÷ 210 generates internally a 24 V_{DC} auxiliary supply through the main power supply; the drive logic can be supplied through X1-IN connector with an external 24 V_{DC} without produce conflict between the internally generated voltage and the auxiliary power supplied externally (is used the source with higher voltage level). This feature allows to configure the drive without main power supply and keep the drive logic switched on even in the absence of the drive main power supply.

11.4 24VDC output power supply (V+_OUT and V0_OUT)

Only for drives type 090 ÷ 210 the 24V_{DC} output power supply is available on pins 1 and 2 of the X1-OUT connector (see 8.6).

This voltage can be used only to provide an auxiliary supply for digital I/O to the drive and provides an auxiliary supply for STO channels function (the auxiliary supply must be interrupted by suitable safety contacts). The output current is internally limited to a 500mA; protection against external over-current and short-circuit.

11.5 Flow reference input signals (Q_INPUT+)

The drive is designed to receive an analog reference input signal (pin 11 on M1) for the servomotor rotation speed.

Flow reference input signal is factory preset, default is 0 ÷ 10 V_{DC}.

Drive with fieldbus interface can be software set to receive reference signal directly from the machine control unit (fieldbus reference).



Input signal can be reconfigured between voltage and current within a maximum range of ±10 V_{DC} or 4 ÷ 20 mA, using specific dip-switch present on the drive. Set the dip-switch with the drive powered off and before making the electrical connections as it would not be possible to remove the cover with connectors wired (see S-MAN-HW installer manual).

11.6 Pressure reference input signal (P_INPUT+)

The drive is designed to receive an analog reference input signal (pin 12 on M3) for the system pressure.

Pressure reference input signal is factory preset, default is 0 ÷ 10 V_{DC}.

Drive with fieldbus interface can be software set to receive reference signal directly from the machine control unit (fieldbus reference).



Input signal can be reconfigured between voltage and current within a maximum range of ±10 V_{DC} or 4 ÷ 20 mA, using specific dip-switch present on the drive. Set the dip-switch with the drive powered off and before making the electrical connections as it would not be possible to remove the cover with connectors wired (see S-MAN-HW installer manual).

11.7 Flow monitor output signal (Q_MONITOR)

The drive generates an analog output signal (pin 15 on M1) for servomotor actual rotation speed.

The monitor output signal can be software set to show other signals available in the drive.

Default is 0 ÷ 10 V_{DC} (10V = 3276,7 rpm). For more information please refer S-MAN-SW programming software manual.

11.8 Pressure monitor output signal (P_MONITOR)

The drive generates an analog output signal (pin 15 on M3) to the system actual pressure.

The monitor output signal can be software set to show other signals available in the drive.

Default is 0 ÷ 10 V_{DC} (10V = 819,2 bar). For more information please refer S-MAN-SW programming software manual.

11.9 Enable input signal (DI1)

To enable the servomotor control, supply a 24 V_{DC} on pin 1 of the M1: Enable input signal allows to enable/disable servomotor control, without removing the electrical power supply to the drive; it is used to keep active the communication and the other driver functions when the drive must be disabled for safety reasons. This condition **does not comply** with norms IEC 61508 and ISO 13849.

Input is optoisolated from the internal regulation (24 V_{DC} ±10% @ I_{max} 10 mA).

11.10 Multiple axis selection input signal (DI2 and DI3)

Two on-off input signals are available on pin 2 and pin 3 of the M1 connector to select one of the four axis parameters setting, stored into the drive.

Switching the active setting of axis during the machine cycle allows to optimize the system dynamic response in different hydraulic working conditions (volume, flow, etc.).

Supply a 24 V_{DC} or a 0 V_{DC} on pin 2 and/or pin 3 of the M1, to select one of the PID settings as indicated by binary code table at side.

Input is optoisolated from the internal regulation (24 V_{DC} ±10% @ I_{max} 10 mA).

PIN	AXIS SELECTION			
	SET 1	SET 2	SET 3	SET 4
M1-2	0	24 V _{DC}	0	24 V _{DC}
M1-3	0	0	24 V _{DC}	24 V _{DC}

11.11 Alarm reset input signal (DI4)

Alarm reset input signal allows to clear all alarms present into the drive: to reset the drive alarms, supply 24 V_{DC} on pin 4 of the M1. Input is optoisolated from the internal regulation (24 V_{DC} ±10% @ I_{max} 10 mA).

11.12 Fault output signal (DO1)

This output signal (pin 6 on M1) indicates fault conditions of the drive (reference or transducer signal cable broken, maximum error exceeded, etc.). Fault presence corresponds to 0 V_{DC}, normal working corresponds to 24 V_{DC}. Fault status is not affected by the status of the Enable input signal.

This output signal can be used as digital output by software selection.

Notes:

- when STO function is enabled the fault output signal is set to 0 V_{DC} (see section 12);
- digital output with fast contact (max 5 kHz)

11.13 STO test suggested output signal (DO2) - for SSP without /D option

This output signal (pin 8 on M1) indicates that the STO test is suggested (see section 12).

STO test suggested corresponds to 24 V_{DC}, while not suggested corresponds to 0 V_{DC}.

STO test suggested logical output signal is not intended as a fault condition.

This output signal can be used as digital output by software selection.

Note: digital output with relay contact

11.14 Smart cooling active output signal (DO2) - for SSP with /D option

This output signal (pin 8 on M1) indicates the working conditions to which the internal gear pump (PGI*) is subject to rapid overheating. For /D option (see AS100) this digital output condition can be used to manage (using an external relay) the JO-DL cartridge installed on the manifold block.

Smart cooling active corresponds to 24 V_{DC}, while not active corresponds to 0 V_{DC}.

Smart cooling active logical output signal is not intended as a fault condition.

This output signal can be used as digital output by software selection.

Note: digital output with relay contact

11.15 Enable P/Q control input signal (DI5)

By default, the P/Q control is always active.

Through S-SW-SETUP software, it's possible to modify the configuration of the drive so that the P/Q control can be enabled/disabled via this digital input:

- when digital input is set to 0V_{DC}, P/Q control is disabled and the drive performs just flow control
- when digital input is set to 24V_{DC}, P/Q control is enabled and the drive performs flow and pressure control

Input is optoisolated from the internal regulation (24 V_{DC} ±10% @ I_{max} 10 mA).

11.16 Pressure smart tuning selection input signals (DI6 and DI7)

Pressure smart tuning selection can be switched from Dynamic (default) to Balanced or Smooth via software, fieldbus or using DI6 and DI7 digital inputs (pin 2 and 3 on M3), as shown at side; if requested, performances can be further customized directly tuning each single PID control parameter.

PIN	SMART TUNING SELECTION		
	DYNAMIC	BALANCED	SMOOTH
M3-2	0	24 V _{DC}	0
M3-3	0	0	24 V _{DC}

11.17 Smart maintenance alert output signal (DO3)

This output signal (pin 6 on M3) indicates that smart maintenance must be performed.

Smart maintenance alert corresponds to 24 V_{DC}, while not alert corresponds to 0 V_{DC}.

This output signal can be used as digital output by software selection.

Note: digital output with fast contact (max 5 kHz)

11.18 STO corrupted output signal (DO4)

This output signal (pin 8 on M3) indicates the presence of fault conditions or the need for specific actions for the STO function.

The STO corrupted corresponds to 24 V_{DC}, while not corrupted corresponds to 0 V_{DC}.

This output signal can be used as digital output by software selection.

Note: digital output with relay contact

11.19 Remote pressure transducer input signals (TR1)

Analog remote pressure transducers can be directly connected to the drive.

Analog input signal (pin 14 on M3) is factory preset, default is 0 ÷ 10 V_{DC}.

Refer to pressure transducer characteristics to select the transducer type according to specific application requirements.

 Input signal can be reconfigured between voltage and current within a maximum range of ±10 V_{DC} or 4 ÷ 20 mA, using specific dip-switch present on the drive. Set the dip-switch with the drive powered off and before making the electrical connections as it would not be possible to remove the cover with connectors wired (see S-MAN-HW installer manual).

12 STO FUNCTION - /K always present

The drive implements the Safe Torque Off (STO) function as a prevention of unexpected starts according to 2006/42/EC Machinery Directive (MD) - standard EN 61800-5-2.

This function is enabled setting 0 V_{DC} on both +24V_STO1 and +24V_STO2 channels. It prevents the generation of a rotating magnetic field removing the power semiconductor control voltage allowing short-term operations (such as cleaning and / or maintenance work on parts of non-electrical devices of the machine) without disconnecting drive power supply or the connection between the drive and the servomotor. For detailed descriptions, please refer to the S-MAN-HW installation manual.

 The STO function must be tested periodically as indicated in the S-MAN-HW manual to avoid the servomotor control is automatically disabled.

 If the STO function is not used, both channels +24V_STO1 and +24V_STO2 must be permanently connected to the 24V voltage.

 Even if the STO function is not used, it is still necessary to periodically test the STO function.

13 POWER AND PROTECTION CABLES SIZE

Drive type	Servomotor type (1)	Drive power cables	Servomotor power cables	Drive, servomotor power cables and breaking cables tightening torque	Protection cables	Protection cables tightening torque	Power cables max length
		[mm ²]	[mm ²]	[Nm]	[mm ²]	[Nm]	[m]
		L1, L2, L3	U, V, W	L1, L2, L3 U, V, W +, F	PE	PE	L1, L2, L3 U, V, W
D-MP*-022	PMM*-1009	6	6	1,7	6	8,5	50 (2)
D-MP*-032	PMM*-1015	10	10	1,7	10		
D-MP*-046	PMM*-1024	16	16	3,8	16		
D-MP*-060	PMM*-1032	25	25	3,8	16		
D-MP*-090	PMM*-2042	50	50	15 - 20	35	15 - 20	
D-MP*-100	PMM*-2055	70	70	15- 20	35		
D-MP*-140		70	70	15 - 20	50		
D-MP*-165	PMM*-2080	95	95	25 - 30	70	25 - 30	
D-MP*-210	PMM*-2100	95	95	25 - 30	70		

(1) For more information about PMM servomotor, please refer tech table **AS400**

(2) With cables longer than 50 meters, 3-phase reactance between the drive and the servomotor is mandatory.
For more information please consult Atos technical office.

14 FUSES

Drive type	Min. short circuit current [A]	Input current without input reactance [A]	Input current with input reactance [A]	Rated current [A]	I ^{2t} clearing @660V, 20°C [A ² s]	Rated voltage [V]	Manufacturer (1)	Type	Size
D-MP*-022	280	31,3	26,0	50	770	700	BUSSMANN	170M1414	000 (3)
D-MP*-032	380	42,2	38	63	1450	700	BUSSMANN	170M1415	000 (3)
D-MP*-046	500	58,5	54,5	80	2550	700	BUSSMANN	170M1416	000 (3)
D-MP*-060	650	71,5	68,1	100	4650	700	BUSSMANN	170M1417	000 (3)
D-MP*-090	1400	10000	103	200	15169	690	Littelfuse	PSR030xx0200 (2)	030
D-MP*-100	1400		118	200	15169	690	Littelfuse	PSR030xx0200 (2)	030
D-MP*-140	2100		166	315	61830	690	Littelfuse	PSR030xx0315 (2)	030
D-MP*-165	2100		195	315	61830	690	Littelfuse	PSR030xx0315 (2)	030
D-MP*-210	3800		249	450	160110	690	Littelfuse	PSR030xx0450 (2)	030

Notes: fuses with higher current rating than the recommended ones must not be used; fuses with lower current rating can be used

(1) fuses from other manufacturers can be used if they meet the ratings and the melting curve of the fuse mentioned in the table

(2) "xx" defines the termination type that can be: US/UL/DS/DL/FS/FL

(3) size according to IEC 60269

D-MP-*-022

Fixing screws = M4

D-MP-*-032

Fixing screws = M4

Mass [kg]	
D-MP-*-022	5.2
D-MP-*-032	5.7

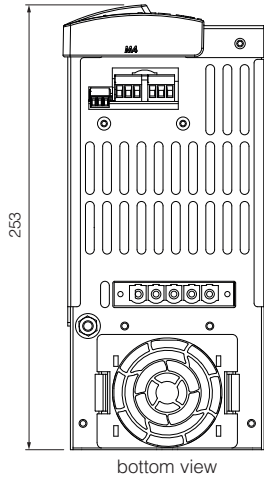

bottom view

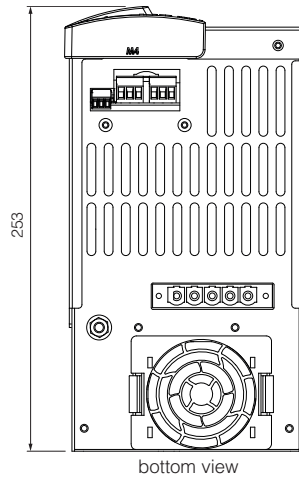

bottom view

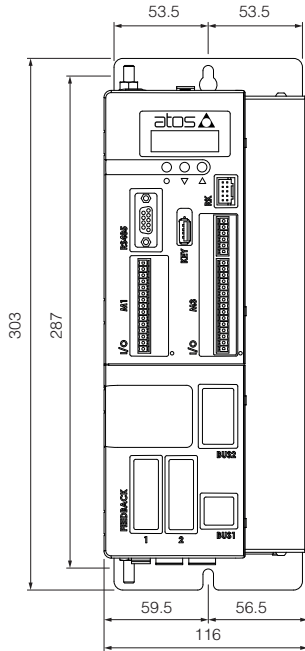

top view

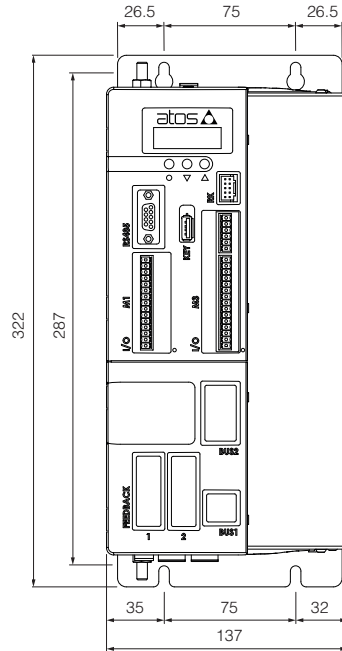

top view

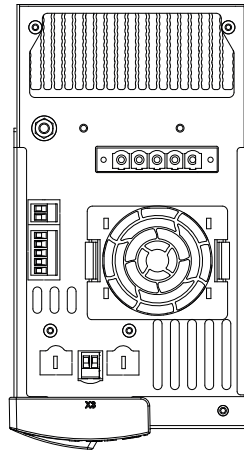
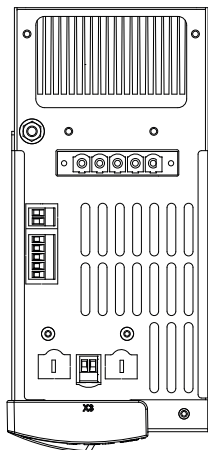

D-MP-*-046
D-MP-*-060

Fixing screws = M4

Mass [kg]	
D-MP-*-046	9.6
D-MP-*-060	

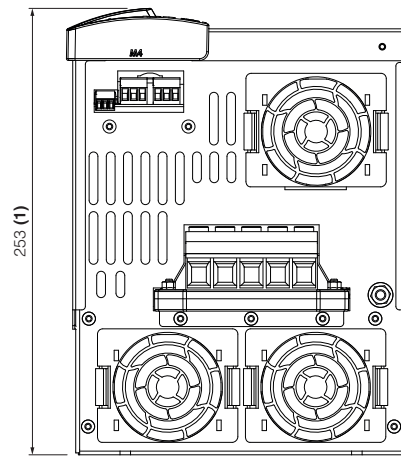

bottom view

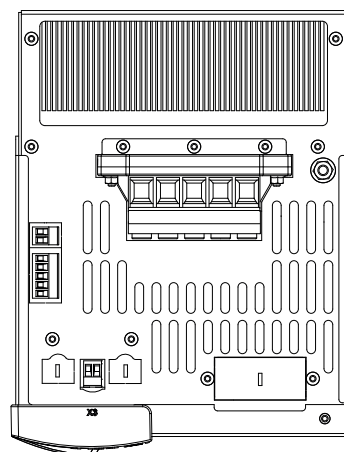
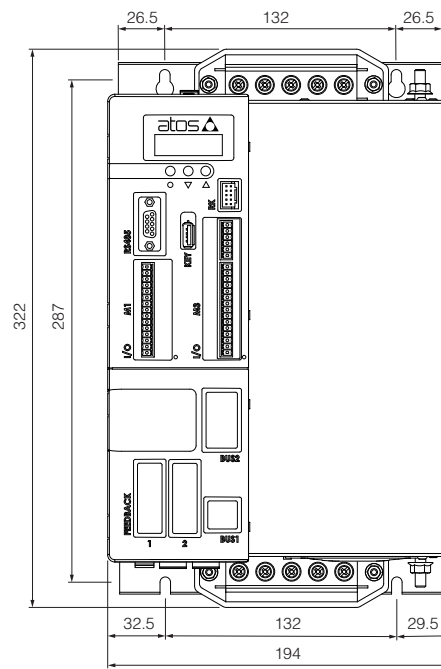

top view

(1) this measure differs from previous D-MP series 10

D-MP-*-165 D-MP-*-210

Fixing screws = M8

Mass [kg]	
D-MP-*-165	50
D-MP-*-210	

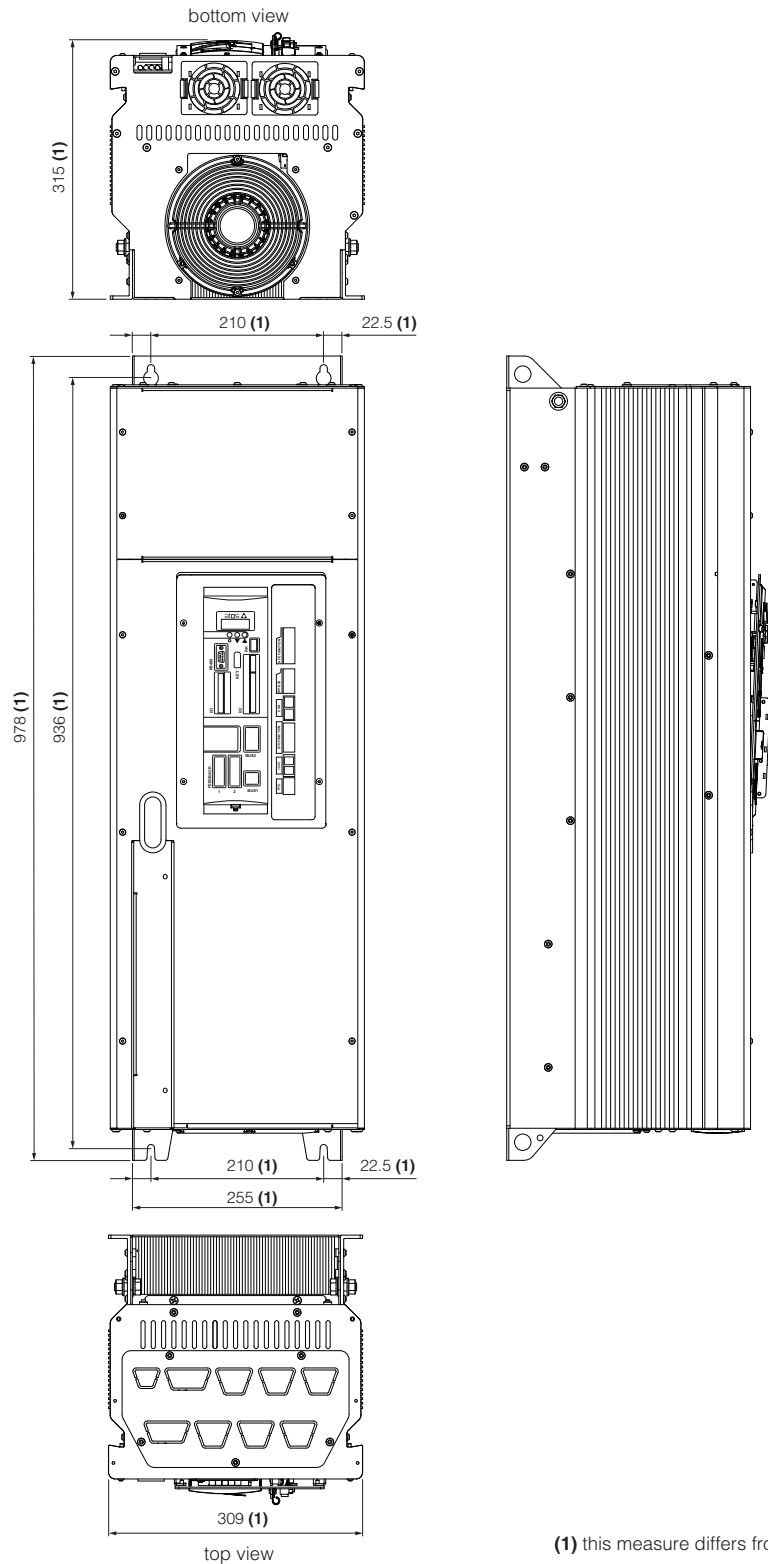

16 RELATED DOCUMENTATION

AS050	Basics for Smart Servopumps - SSP	AS800	Programming tools for pumps & servopumps
AS100	SSP Smart Servopumps	AS810	Accessories for servopumps
AS200	Sizing criteria for servopumps	AS910	Operating and maintenance information for servopumps
AS300	PGI cast iron internal gear pumps, high pressure	GS510	Fieldbus
AS320	PGIX2 cast iron double internal gear pumps	S-MAN-HW	Servopumps installation manual
AS350	PGIL aluminium internal gear pumps	S-MAN-SW	Servopumps programming software manual
AS400	PMM high performance synchronous servomotors		