

# Ex-proof digital proportional relief valves

direct or piloted, with on-board driver and without transducer - **ATEX, IECEx, CCC**

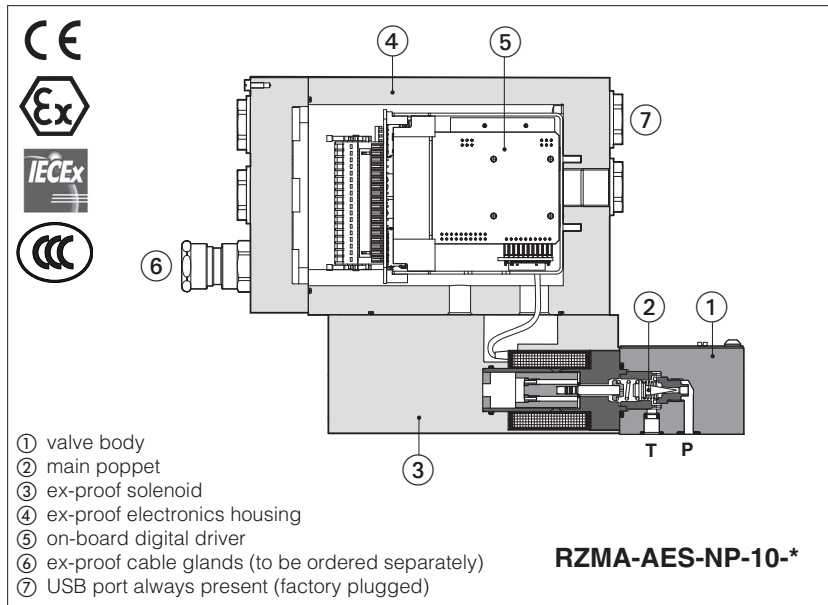

- ① valve body
- ② main poppet
- ③ ex-proof solenoid
- ④ ex-proof electronics housing
- ⑤ on-board digital driver
- ⑥ ex-proof cable glands (to be ordered separately)
- ⑦ USB port always present (factory plugged)

## RZMA-AES, AGMZA-AES

Ex-proof digital proportional relief valves direct or piloted without transducer for pressure open loop controls.

They are equipped with ex-proof on-board digital driver and proportional solenoid certified for safe operations in hazardous environments with potentially explosive atmosphere.

- Multicertification **ATEX, IECEx, CCC** for gas group **II 2G** and dust category **II 2D**

The flameproof enclosure of on-board digital driver and solenoid, prevents the propagation of accidental internal sparks or fire to the external environment.

The driver and solenoid are also designed to limit the surface temperature within the classified limits.

**RZMA**, direct or piloted:

Size: **06** -ISO 4401

Max flow: **4** and **40** l/min

**AGMZA**, piloted:

Size: **10, 20** and **32** -ISO 6264

Max flow: **200, 400** and **600** l/min

Max pressure: **250** bar

## 1 MODEL CODE

<b>RZMA</b>	-	<b>AES</b>	-	<b>NP</b>	-	<b>010</b>	/	<b>250</b>	/	<b>M</b>	/	<b>*</b>	/	<b>*</b>	/	<b>*</b>
<p>Ex-proof proportional pressure relief valves</p> <p><b>RZMA</b> = subplate size 06 <b>AGMZA</b> = subplate size 10, 20, 32</p> <p><b>AES</b> = on-board driver, without transducer</p> <p><b>Fieldbus interfaces</b>, USB port always present: <b>NP</b> = Not Present <b>BC</b> = CANopen <b>BP</b> = PROFIBUS DP <b>EH</b> = EtherCAT</p> <p><b>Valve size and configuration:</b> RZMA: direct      <b>010</b> = Qmax 4 l/min RZMA: piloted    <b>030</b> = Qmax 40 l/min AGMZA: piloted    <b>10, 20, 32</b> = Qmax 200, 400, 600 l/min</p> <p><b>Seals material</b>, see section 9: - = NBR <b>PE</b> = FKM <b>BT</b> = HNBR</p> <p>Series number</p> <p><b>Hydraulic options</b> - only AGMZA (1): <b>E</b> = external pilot <b>Y</b> = external drain</p> <p><b>Electronic options (1):</b> <b>I</b> = current reference input 4÷20 mA (omit for std voltage 0÷10Vdc)</p> <p><b>Cable entrance threaded connection:</b> <b>M</b> = M20x1,5</p> <p><b>Max regulated pressure:</b> <b>80</b> = 80 bar    <b>180</b> = 180 bar    <b>250</b> = 250 bar</p>																

(1) Possible combined options: /EY, /EI, /YI

## 2 CONFIGURATIONS AND HYDRAULIC SYMBOLS (representation according to ISO 1219-1)

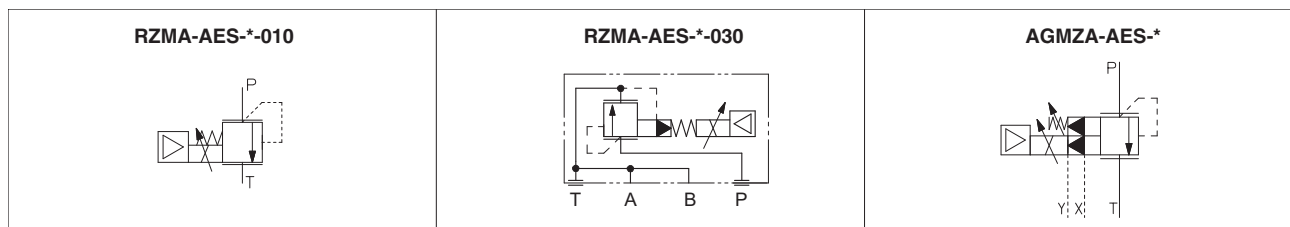

### 3 GENERAL NOTES

Atos digital proportionals valves are CE marked according to the applicable directives (e.g. Immunity and Emission EMC Directive). Installation, wirings and start-up procedures must be performed according to the general prescriptions shown in tech table **FX900** and in the user manuals included in the E-SW-\* programming software.

### 4 VALVE SETTINGS AND PROGRAMMING TOOLS

**WARNING:** the below operation must be performed in a safety area

Valve's functional parameters and configurations, can be easily set and optimized using Atos E-SW programming software connected via USB port to the digital driver (see table **GS003**). For fieldbus versions, the software permits valve's parameterization through USB port also if the driver is connected to the central machine unit via fieldbus.

The software is available in different versions according to the driver's options (see table **GS500**):

**E-SW-BASIC** support: NP (USB) PS (Serial) IR (Infrared)  
**E-SW-FIELDBUS** support: BC (CANopen) BP (PROFIBUS DP) EH (EtherCAT)  
 EW (POWERLINK) EI (EtherNet/IP) EP (PROFINET)  
**E-SW-\*/PQ** support: valves with SP, SF, SL alternated control (e.g. E-SW-BASIC/PQ)

**WARNING: drivers USB port is not isolated!** For E-C-SB-USB/M12 cable, the use of isolator adapter is highly recommended for PC protection

**WARNING:** see tech table **GS500** for the list of countries where the Bluetooth adapter has been approved

#### USB or Bluetooth connection

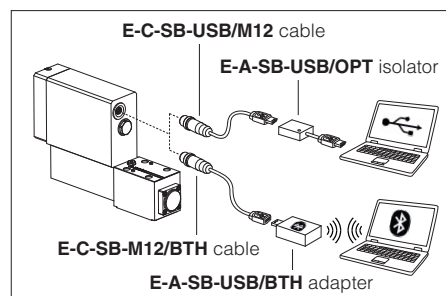

### 5 FIELDBUS - see tech. table **GS510**

Fieldbus allows valve direct communication with machine control unit for digital reference, valve diagnostics and settings. These executions allow to operate the valves through fieldbus or analog signals available on the terminal board.

### 6 GENERAL CHARACTERISTICS

Assembly position	Any position
Subplate surface finishing to ISO 4401	Acceptable roughness index, Ra ≤0,8 recommended Ra 0,4 - flatness ratio 0,01/100
MTTFd valves according to EN ISO 13849	RZMA-010 150 years, RZMA-030 and AGMZA 75 years, see technical table P007
Ambient temperature range	<b>Standard</b> = -20°C ÷ +60°C <b>/PE</b> option = -20°C ÷ +60°C <b>/BT</b> option = -40°C ÷ +60°C
Storage temperature range	<b>Standard</b> = -20°C ÷ +70°C <b>/PE</b> option = -20°C ÷ +70°C <b>/BT</b> option = -40°C ÷ +70°C
Surface protection	Zinc coating with black passivation - salt spray test (EN ISO 9227) > 200 h
Compliance	Explosion proof protection, see section <b>10</b> -Flame proof enclosure "Ex d" -Dust ignition protection by enclosure "Ex t" RoHs Directive 2011/65/EU as last update by 2015/863/EU REACH Regulation (EC) n°1907/2006

### 7 HYDRAULIC CHARACTERISTICS - based on mineral oil ISO VG 46 at 50 °C

Valve model	RZMA		AGMZA		
Size code	010	030	10	20	32
Valve size	06		10	20	32
Max regulated pressure [bar]	80 180		250		
Min regulated pressure [bar]	see min. pressure / flow diagrams at sections <b>18</b> <b>19</b> <b>20</b>				
Max pressure at port P, A, B, X [bar]	315				
Max pressure at port T, Y [bar]	210				
Max flow [l/min]	4	40	200	400	600
Response time 0-100% step signal (depending on installation) <b>(1)</b> [ms]	≤ 80		≤ 130	≤ 145	≤ 160
Hysteresis [% of the max pressure]	≤ 1,5				
Linearity [% of the max pressure]	≤ 3				
Repeatability [% of the max pressure]	≤ 2				

**(1)** Average response time value; the pressure variation in consequence of a modification of the reference input signal to the valve is affected by the stiffness of the hydraulic circuit: greater is the stiffness of the circuit, faster is the dynamic response

## 8 ELECTRICAL CHARACTERISTICS

Power supplies	Nominal : +24 VDC Rectified and filtered : VRMS = 20 ÷ 32 VMAX (ripple max 10 % VPP)			
Max power consumption	35 W			
Analog input signals	Voltage: range ±10 VDC (24 VMAX tollerant) Current: range ±20 mA		Input impedance: Ri > 50 kΩ Input impedance: Ri = 500 Ω	
Insulation class	H (180°) Due to the occurring surface temperatures of the solenoid coils, the European standards ISO 13732-1 and EN982 must be taken into account			
Monitor outputs	Voltage: maximum range ± 5 VDC @ max 5 mA			
Enable input	Range: 0 ÷ 9 VDC (OFF state), 15 ÷ 24 VDC (ON state), 9 ÷ 15 VDC (not accepted); Input impedance: Ri > 87kΩ			
Fault output	Output range : 0 ÷ 24 VDC (ON state ≡ VL+ [logic power supply] ; OFF state ≡ 0 V) @ max 50 mA; external negative voltage not allowed (e.g. due to inductive loads)			
Alarms	Solenoid not connected/short circuit, cable break with current reference signal, over/under temperature, current control monitoring, power supplies level			
Protection degree to DIN EN60529	IP66/67 with relevant cable gland			
Duty factor	Continuous rating (ED=100%)			
Tropicalization	Tropical coating on electronics PCB			
Additional characteristics	Short circuit protection of solenoid current supply; current control by P.I.D. with rapid solenoid switching; protection against reverse polarity of power supply			
Electromagnetic compatibility (EMC)	According to Directive 2014/30/UE (Immunity: EN 61000-6-2; Emission: EN 61000-6-3)			
Communication interface	USB Atos ASCII coding	CANopen EN50325-4 + DS408	PROFIBUS DP EN50170-2/IEC61158	EtherCAT EC 61158
Communication physical layer	not insulated USB 2.0 + USB OTG	optical insulated CAN ISO11898	optical insulated RS485	Fast Ethernet, insulated 100 Base TX

**Note:** a maximum time of 500 ms (depending on communication type) have be considered between the driver energizing with the 24 VDC power supply and when the valve is ready to operate. During this time the current to the valve coils is switched to zero

## 9 SEALS AND HYDRAULIC FLUIDS - for other fluids not included in below table, consult our technical office

Seals, recommended fluid temperature	NBR seals (standard) = -20°C ÷ +60°C, with HFC hydraulic fluids = -20°C ÷ +50°C FKM seals (/PE option) = -20°C ÷ +80°C HNBR seals (/BT option) = -40°C ÷ +60°C, with HFC hydraulic fluids = -40°C ÷ +50°C		
Recommended viscosity	20 ÷ 100 mm²/s - max allowed range 15 ÷ 380 mm²/s		
Max fluid contamination level	normal operation	ISO4406 class 18/16/13 NAS1638 class 7	see also filter section at
	longer life	ISO4406 class 16/14/11 NAS1638 class 5	www.atos.com or KTF catalog
<b>Hydraulic fluid</b>	<b>Suitable seals type</b>	<b>Classification</b>	<b>Ref. Standard</b>
Mineral oils	NBR, FKM, HNBR	HL, HLP, HLPD, HVLP, HVLDP	DIN 51524
Flame resistant without water	FKM	HF DU, HF DR	ISO 12922
Flame resistant with water <b>(1)</b>	NBR, HNBR	HFC	

⚠ The ignition temperature of the hydraulic fluid must be 50°C higher than the max solenoid surface temperature

### (1) Performance limitations in case of flame resistant fluids with water:

- max operating pressure = 210 bar
- max fluid temperature = 50°C

## 10 CERTIFICATION DATA

Valve type	RZMA, AGMZA		
Certifications	Multicertification Group II <b>ATEX IECEx CCC</b>		
Solenoid certified code	<b>OZA-AES</b>		
Type examination certificate <b>(1)</b>	• ATEX: TUV IT 18 ATEX 068 X	• IECEx: IECEx TPS 19.0004X	• CCC: 2021322307004057
Method of protection	• ATEX 2014/34/EU Ex II 2G Ex db IIC T6/T5/T4 Gb; Ex II 2D Ex tb IIIC T85°C/T100°C/T135°C Db • IECEx Ex db IIC T6/T5/T4 Gb; Ex tb IIIC T85°C/T100°C/T135°C Db • CCC Ex d IIC T6/T5/T4 Gb; Ex tD A21 IP66/IP67 T85°C/T100°C/T135°C		
Temperature class	<b>T6</b>	<b>T5</b>	<b>T4</b>
Surface temperature	≤ 85 °C	≤ 100 °C	≤ 135 °C
Ambient temperature <b>(2)</b>	-40 ÷ +40 °C	-40 ÷ +55 °C	-40 ÷ +70 °C
Applicable Standards	EN 60079-0:2012+A11:2013 EN 60079-1:2014	EN 60079-31:2014	IEC 60079-0:2017 IEC 60079-1:2014
Cable entrance: threaded connection	<b>M = M20x1,5</b>		

**(1)** The type examiner certificates can be downloaded from [www.atos.com](http://www.atos.com)

**(2)** The driver and solenoids are certified for minimum ambient temperature -40°C.  
In case the complete valve must withstand with minimum ambient temperature -40°C, select **/BT** in the model code.

⚠ **WARNING: service work performed on the valve by the end users or not qualified personnel invalidates the certification**

**11 CABLE SPECIFICATION AND TEMPERATURE** - Power supply and grounding cables have to comply with following characteristics:

<b>Power supply and signals:</b> section of wire = 1,0 mm <sup>2</sup>	<b>Grounding:</b> section of external ground wire = 4 mm <sup>2</sup>
--	---

**11.1 Cable temperature**

The cable must be suitable for the working temperature as specified in the "safety instructions" delivered with the first supply of the products.

Max ambient temperature [°C]	Temperature class	Max surface temperature [°C]	Min. cable temperature [°C]
40 °C	T6	85 °C	80 °C
55 °C	T5	100 °C	90 °C
70 °C	T4	135 °C	110 °C

**12 CABLE GLANDS**

Cable glands with threaded connections M20x1,5 for standard or armoured cables have to be ordered separately, see tech table **KX600**

**Note:** a Loctite sealant type 545, should be used on the cable gland entry threads

**13 HYDRAULIC OPTIONS** - only for AGMZA

**E** = External pilot option to be selected when the pilot pressure is supplied from a different line respect to the P main line.  
With option E the internal connection between port P and X of the valve is plugged. The pilot pressure must be connected to the X port available on the valve's mounting surface or on main body (threaded pipe connection G 1/4").

**Y** = The external drain is mandatory in case the main line T is subjected to pressure peaks or it is pressurized.  
The Y drain port has a threaded connection G 1/4" available on the pilot stage body.

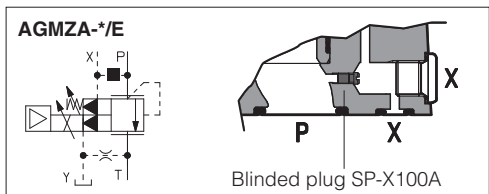

**14 ELECTRONIC OPTIONS**

**I** = It provides 4 ÷ 20 mA current reference signal, instead of the standard 0 ÷ 10 V<sub>dc</sub>. Input signal can be reconfigured via software selecting between voltage and current, within a maximum range of ±10 V<sub>dc</sub> or ±20 mA. It is normally used in case of long distance between the machine control unit and the valve or where the reference signal can be affected by electrical noise; the valve functioning is disabled in case of reference signal cable breakage.

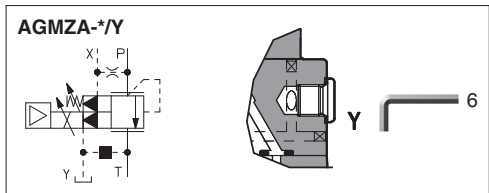

**15 POSSIBLE COMBINED OPTIONS**

/EY, /EI, /YI

**16 MECHANICAL PRESSURE LIMITER** - only for AGMZA

The AGMZA are provided with mechanical pressure limiter acting as protection against overpressure. For safety reasons the factory setting of the mechanical pressure limiter is fully unloaded (min pressure). At the first commissioning it must be set at a value lightly higher than the max pressure regulated with the proportional control. For the pressure setting of the mechanical pressure limiter, proceed according to following steps:

- apply the max reference input signal to the valve's driver. The system pressure will not increase until the mechanical pressure limiter remains unloaded.
- turn clockwise the adjustment screw ① until the system pressure will increase up to a stable value corresponding to the pressure setpoint at max reference input signal.
- turn clockwise the adjustment screw ① of additional 1 or 2 turns to ensure that the mechanical pressure limiter remains closed during the proportional valve working.

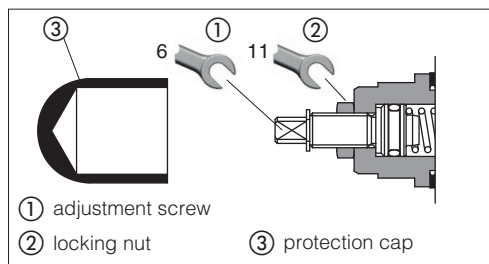

**17 REMOTE PRESSURE UNLOADING** - only for AGMZA

The **P** main line can be remotely unloaded by connecting the valve X port to a solenoid valve as shown in the below scheme (venting valve). This function can be used in emergency to unload the system pressure by-passing the proportional control.

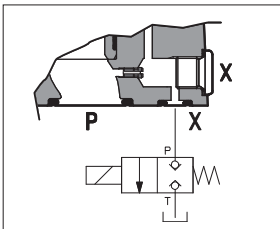

**18 DIAGRAMS RZMA-010** (based on mineral oil ISO VG 46 at 50 °C)

**1 Regulation diagrams**  
with flow rate Q = 1 l/min

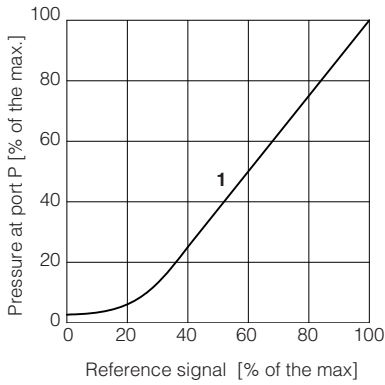

**2 Pressure/flow diagrams**  
with reference signal set at Q = 1 l/min

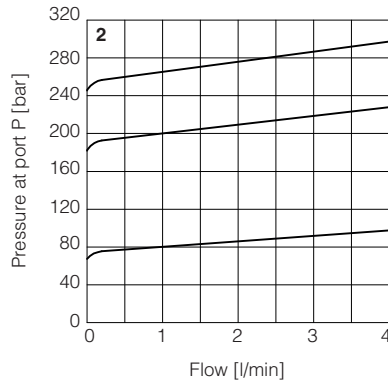

**3-5 Min. pressure/flow diagrams**  
with zero reference signal

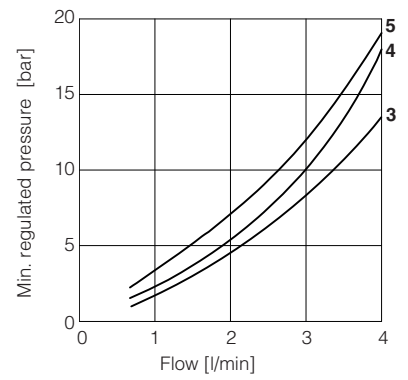

**3** = RZMA/80  
**4** = RZMA/180  
**5** = RZMA/250

**Note:** the presence of counter pressure at port T can affect the pressure regulation and the minimum pressure

**19 DIAGRAMS RZMA-030** (based on mineral oil ISO VG 46 at 50 °C)

**1 Regulation diagrams**  
with flow rate Q = 10 l/min

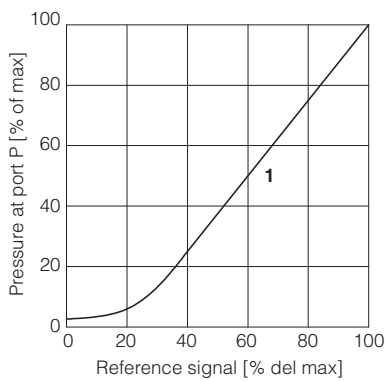

**2 Pressure/flow diagrams**  
with reference signal set at Q = 10 l/min

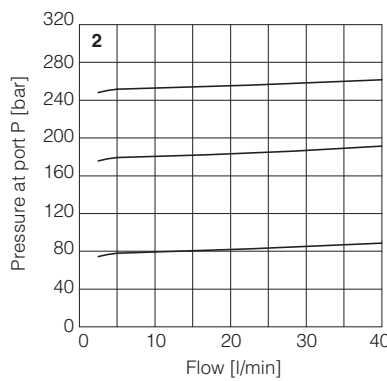

**3 Min. pressure/flow diagrams**  
with zero reference signal

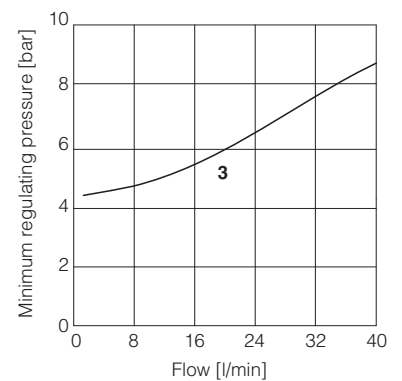

**Note:** the presence of counter pressure at port T can affect the pressure regulation and the minimum pressure

**20 DIAGRAMS AGMZA** (based on mineral oil ISO VG 46 at 50 °C)

**1 = Regulation diagrams**  
with flow rate Q = 50 l/min

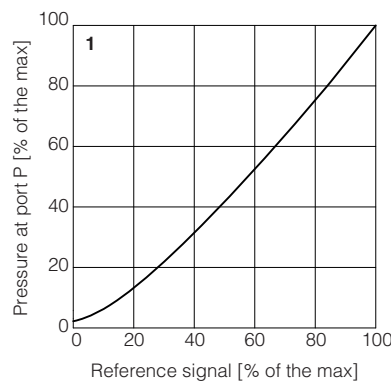

**2 = Pressure/flow diagrams**  
with reference signal set at Q = 50 l/min

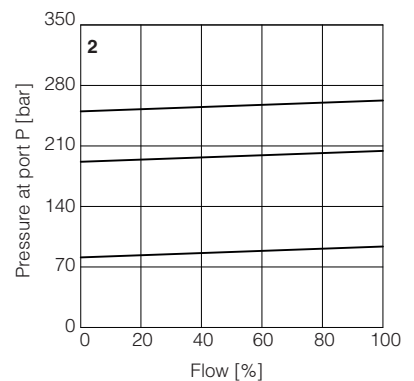

**3-5 = Min. pressure/flow diagrams**  
with zero reference signal

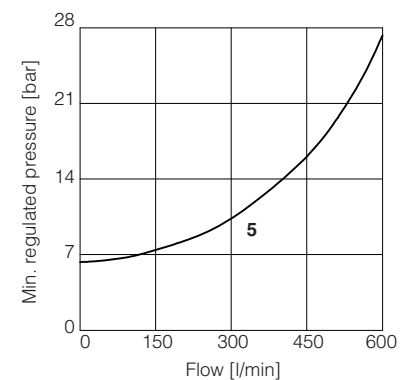
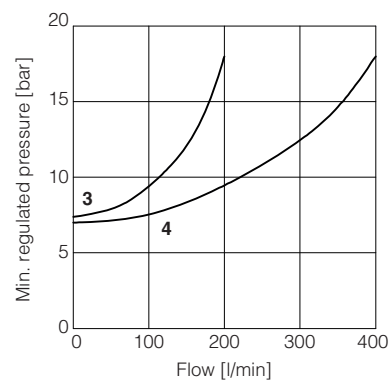

**3** = AGMZA-\*-10  
**4** = AGMZA-\*-20  
**5** = AGMZA-\*-32

## 21 POWER SUPPLY AND SIGNALS SPECIFICATIONS

Generic electrical output signals of the valve (e.g. fault or monitor signals) must not be directly used to activate safety functions, like to switch-ON/OFF the machine's safety components, as prescribed by the European standards (Safety requirements of fluid technology systems and components-hydraulics, EN-982).

### 21.1 Power supply (V+ and V0)

The power supply must be appropriately stabilized or rectified and filtered: apply at least a 10000  $\mu\text{F}/40\text{ V}$  capacitance to single phase rectifiers or a 4700  $\mu\text{F}/40\text{ V}$  capacitance to three phase rectifiers.

 A safety fuse is required in series to each power supply: 2,5 A time lag fuse.

### 21.2 Power supply for driver's logic and communication (VL+ and VL0)

The power supply for driver's logic and communication must be appropriately stabilized or rectified and filtered: apply at least a 10000  $\mu\text{F}/40\text{ V}$  capacitance to single phase rectifiers or a 4700  $\mu\text{F}/40\text{ V}$  capacitance to three phase rectifiers.

The separate power supply for driver's logic on pin 3 and 4, allow to remove solenoid power supply from pin 1 and 2 maintaining active the diagnostics, USB and fieldbus communications.

 A safety fuse is required in series to each driver's logic and communication power supply: 500 mA fast fuse.

### 21.3 Flow reference input signal (INPUT+)

The driver controls in closed loop the valve spool position proportionally to the external reference input signal.

Reference input signal is factory preset according to selected valve code, defaults are 0  $\div$  10 VDC for standard and 4  $\div$  20 mA for /I option.

Input signal can be reconfigured via software selecting between voltage and current, within a maximum range of  $\pm 10\text{ VDC}$  or  $\pm 20\text{ mA}$ .

Drivers with fieldbus interface can be software set to receive reference signal directly from the machine control unit (fieldbus reference). Analog reference input signal can be used as on-off commands with input range 0  $\div$  24VDC.

### 21.4 Monitor output signal (MONITOR)

The driver generates an analog output signal (MONITOR) proportional to the actual coil current of the valve; the monitor output signal can be software set to show other signals available in the driver (e.g. analog reference, fieldbus reference).

Monitor output signal is factory preset according to selected valve code, default settings is 0  $\div$  5 Vdc (1V = 1A).

Output signal can be reconfigured via software, within a maximum range of  $\pm 5\text{ Vdc}$ .

### 21.5 Enable input signal (ENABLE)

To enable the driver, supply a 24 VDC on pin 6: Enable input signal allows to enable/disable the current supply to the solenoid, without removing the electrical power supply to the driver; it is used to active the communication and the other driver functions when the valve must be disabled for safety reasons. This condition **does not comply** with norms IEC 61508 and ISO 13849.

Enable input signal can be used as generic digital input by software selection.

### 21.6 Fault output signal (FAULT)

Fault output signal indicates fault conditions of the driver (solenoid short circuits/not connected, reference signal cable broken for 4  $\div$  20 mA input, spool position transducer cable broken, etc.). Fault presence corresponds to 0 VDC, normal working corresponds to 24 VDC.

Fault status is not affected by the Enable input signal. Fault output signal can be used as digital output by software selection.

## 22 TERMINAL BOARD OVERVIEW

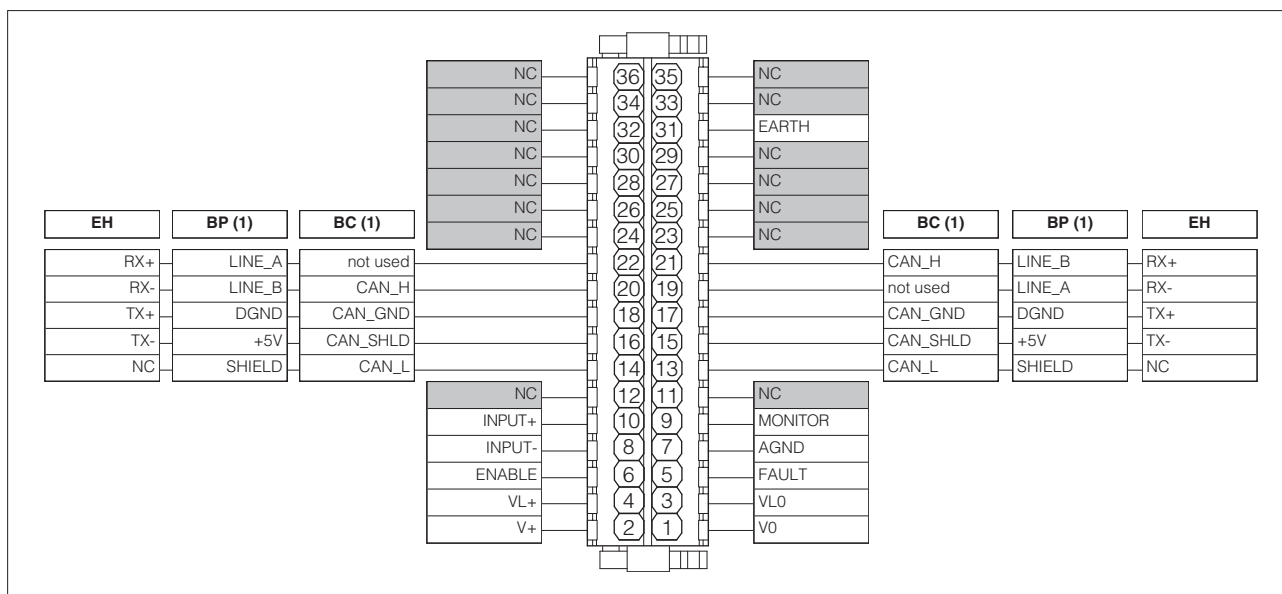

(1) For BC and BP executions the fieldbus connections have an internal pass-through connection

**23 ELECTRONIC CONNECTIONS**

**23.1 Main connections signals**

CABLE ENTRANCE	PIN	SIGNAL	TECHNICAL SPECIFICATIONS	NOTES
<b>A</b>	1	<b>V0</b>	Power supply 0 Vdc	Gnd - power supply
	2	<b>V+</b>	Power supply 24 Vdc	Input - power supply
	3	<b>VL0</b>	Power supply 0 Vdc for driver's logic and communication	Gnd - power supply
	4	<b>VL+</b>	Power supply 24 Vdc for driver's logic and communication	Input - power supply
	5	<b>FAULT</b>	Fault (0 Vdc) or normal working (24 Vdc), referred to VL0	Output - on/off signal
	6	<b>ENABLE</b>	Enable (24 Vdc) or disable (0 Vdc) the driver, referred to VL0	Input - on/off signal
	7	<b>AGND</b>	Analog ground	Gnd - analog signal
	8	<b>INPUT-</b>	Negative reference input signal for INPUT+	Input - analog signal
	9	<b>MONITOR</b>	Monitor output signal: ±5 Vdc maximum range, referred to AGND Default is: ±5 Vdc	Output - analog signal <b>Software selectable</b>
	10	<b>INPUT+</b>	Reference input signal: ±10 Vdc / ±20 mA maximum range Defaults are: ±10 Vdc for standard and 4 ÷ 20 mA for /I option	Input - analog signal <b>Software selectable</b>
	31	<b>EARTH</b>	Internally connected to driver housing	

**23.2 USB connector - M12 - 5 pin** always present

CABLE ENTRANCE	PIN	SIGNAL	TECHNICAL SPECIFICATIONS
<b>B</b>	1	<b>+5V_USB</b>	Power supply
	2	<b>ID</b>	Identification
	3	<b>GND_USB</b>	Signal zero data line
	4	<b>D-</b>	Data line -
	5	<b>D+</b>	Data line +

Driver view  
(female)

**23.3 BC fieldbus execution connections**

CABLE ENTRANCE	PIN	SIGNAL	TECHNICAL SPECIFICATIONS
<b>C1</b>	14	<b>CAN_L</b>	Bus line (low)
	16	<b>CAN_SHLD</b>	Shield
	18	<b>CAN_GND</b>	Signal zero data line
	20	<b>CAN_H</b>	Bus line (high)
	22	<b>not used</b>	Pass-through connection <b>(1)</b>

CABLE ENTRANCE	PIN	SIGNAL	TECHNICAL SPECIFICATIONS
<b>C2</b>	13	<b>CAN_L</b>	Bus line (low)
	15	<b>CAN_SHLD</b>	Shield
	17	<b>CAN_GND</b>	Signal zero data line
	19	<b>not used</b>	Pass-through connection <b>(1)</b>
	21	<b>CAN_H</b>	Bus line (high)

**(1)** Pin 19 and 22 can be fed with external +5V supply of CAN interface

**23.4 BP fieldbus execution connections**

CABLE ENTRANCE	PIN	SIGNAL	TECHNICAL SPECIFICATIONS
<b>C1</b>	14	<b>SHIELD</b>	
	16	<b>+5V</b>	Power supply
	18	<b>DGND</b>	Data line and termination signal zero
	20	<b>LINE_B</b>	Bus line (low)
	22	<b>LINE_A</b>	Bus line (high)

CABLE ENTRANCE	PIN	SIGNAL	TECHNICAL SPECIFICATIONS
<b>C2</b>	13	<b>SHIELD</b>	
	15	<b>+5V</b>	Power supply
	17	<b>DGND</b>	Data line and termination signal zero
	19	<b>LINE_A</b>	Bus line (high)
	21	<b>LINE_B</b>	Bus line (low)

**23.5 EH fieldbus execution connections**

CABLE ENTRANCE	PIN	SIGNAL	TECHNICAL SPECIFICATIONS
<b>C1</b> (input)	14	<b>NC</b>	do not connect
	16	<b>TX-</b>	Transmitter
	18	<b>TX+</b>	Transmitter
	20	<b>RX-</b>	Receiver
	22	<b>RX+</b>	Receiver

CABLE ENTRANCE	PIN	SIGNAL	TECHNICAL SPECIFICATIONS
<b>C2</b> (output)	13	<b>NC</b>	do not connect
	15	<b>TX-</b>	Transmitter
	17	<b>TX+</b>	Transmitter
	19	<b>RX-</b>	Receiver
	21	<b>RX+</b>	Receiver

**CABLE ENTRANCE OVERVIEW**

**Cables entrance description:**

- (A) main connections
- (B) USB connector always present (factory plugged)
- (C1) fieldbus interface (input)
- (C2) fieldbus interface (output)
- (P) threaded plug

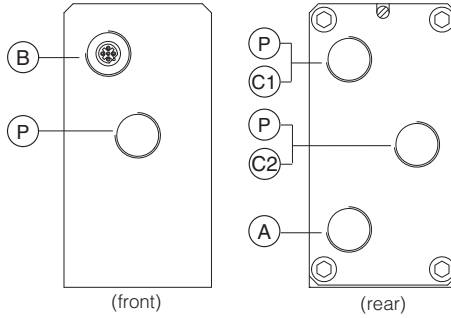

**TERMINAL BOARD AND FIELDBUS TERMINATOR**

Remove the 4 screws of driver's rear cover to access terminal board and fieldbus terminator

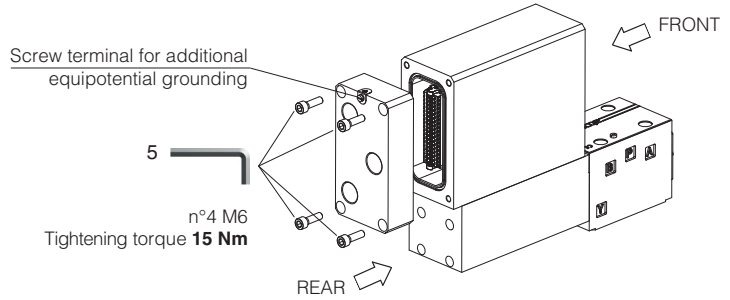

**WARNING:** the above operation must be performed in a safety area

Terminal board - see section 22

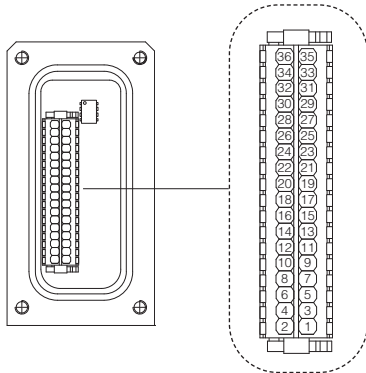

Fieldbus terminator only for BC and BP executions (1)

**BC - CANopen setting:**

Switch	Termination enabled
1	OFF
2	OFF
3	OFF
4	ON

**BP - PROFIBUS DP setting:**

Switch	Termination enabled
1	ON
2	ON
3	OFF
4	OFF

**USB CONNECTOR**

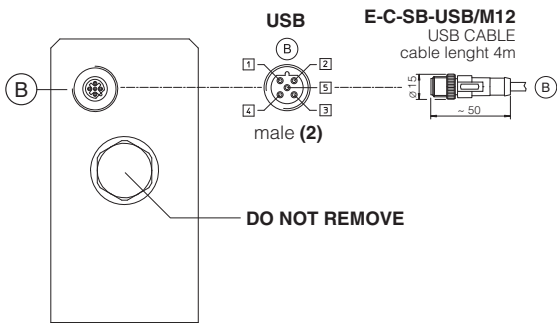

**METALLIC PROTECTION CAP - supplied with the valves**

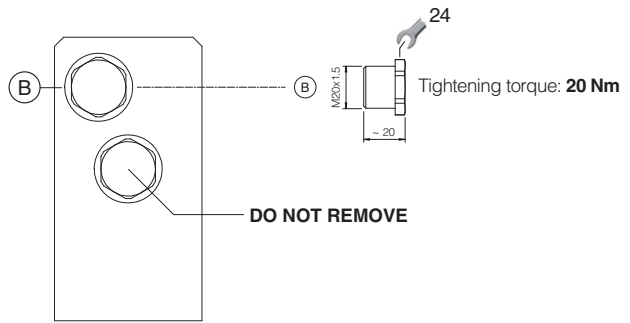

(1) Drivers with BC and BP fieldbus interface are delivered by default 'Not Terminated'. All switches are set OFF  
 (2) Pin layout always referred to driver's view



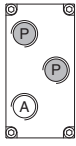
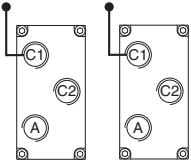
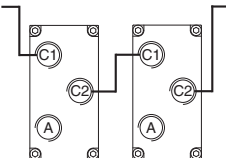

**24.1 Cable glands and threaded plug** - see tech table **KX800**

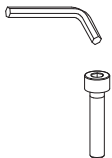

Communication interfaces	To be ordered separately				Cable entrance overview	Notes
	Cable gland quantity	entrance	Threaded plug quantity	entrance		
NP	1	A	none	none		Cable entrance P are factory plugged Cable entrance A is open for costumers
BC, BP, EH "via stub" connection	2	C1 A	1	C2		Cable entrance A, C1, C2 are open for costumers
BC, BP, EH "daisy chain" connection	3	C1 C2 A	none	none		Cable entrance A, C1, C2 are open for costumers

**25 FASTENING BOLTS AND SEALS**

**25.1 RZMA valves**

	<b>RZMA-AES-*-010</b>	<b>RZMA-AES-*-030</b>
	<p><b>Fastening bolts:</b> 4 socket head screws M5x50 class 12.9 Tightening torque = 8 Nm</p>	<p><b>Fastening bolts:</b> 4 socket head screws M5x50 class 12.9 Tightening torque = 8 Nm</p>
	<p><b>Seals:</b> 2 OR 108 Diameter of ports P, T: Ø 5 mm</p>	<p><b>Seals:</b> 4 OR 108 Diameter of ports P, T: Ø 7,5 mm</p>

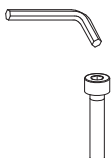
**25.2 AGMZA valves**

	<b>AGMZA-AES-*-10</b>	<b>AGMZA-AES-*-20</b>	<b>AGMZA-AES-*-32</b>
	<p><b>Fastening bolts:</b> 4 socket head screws M12x35 class 12.9 Tightening torque = 125 Nm</p>	<p><b>Fastening bolts:</b> 4 socket head screws M16x50 class 12.9 Tightening torque = 300 Nm</p>	<p><b>Fastening bolts:</b> 4 socket head screws M20x60 class 12.9 Tightening torque = 600 Nm</p>
	<p><b>Seals:</b> 2 OR 123 Diameter of ports P, T: Ø 14 mm 1 OR 109/70 Diameter of port X: Ø 3,2 mm</p>	<p><b>Seals:</b> 2 OR 4112 Diameter of ports P, T: Ø 24 mm 1 OR 109/70 Diameter of port X: Ø 3,2 mm</p>	<p><b>Seals:</b> 2 OR 4131 Diameter of ports P, T: Ø 28 mm 1 OR 109/70 Diameter of port X: Ø 3,2 mm</p>

**RZMA-AES-\*-010**

ISO 4401: 2005

Mounting surface: 4401-03-02-0-05 (see table P005)  
(without ports A and B)

Mass [kg]	
RZMA-AES-*-010	8

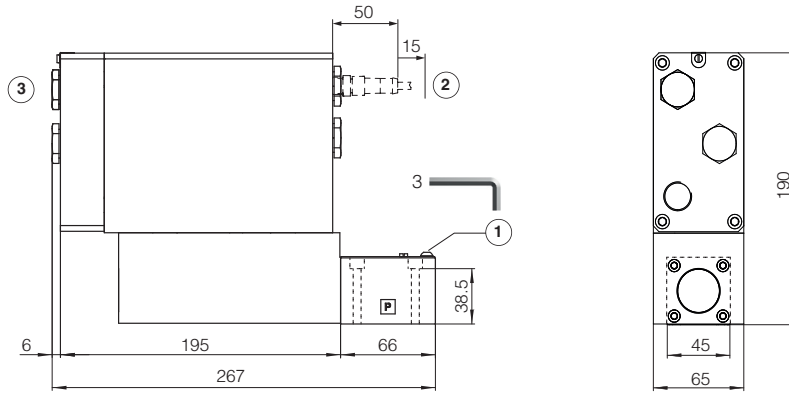

**RZMA-AES-\*-030**

ISO 4401: 2005

Mounting surface: 4401-03-02-0-05 (see table P005)  
(ports A and B connected to port T)

Mass [kg]	
RZMA-AES-*-030	9

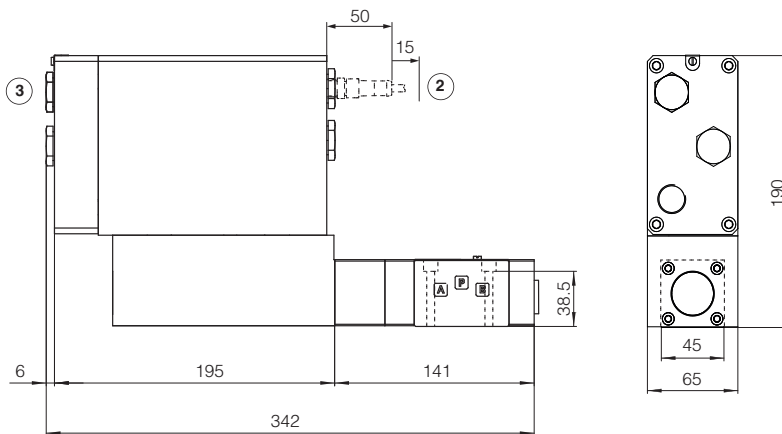

- ① = Air bleed off
- ② = Space to remove the USB connector
- ③ = The dimensions of cable glands must be considered (see tech table **KX800**)

27 INSTALLATION DIMENSIONS FOR AGMZA [mm]

**AGMZA-AES-\*-10**

ISO 6264: 2007  
 Mounting surface: 6264-06-09-1-97  
 (see table P005)

Mass [kg]	
AGMZA-AES-*-10	11,6

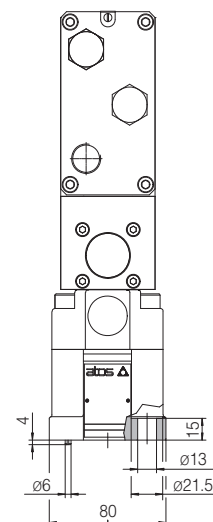
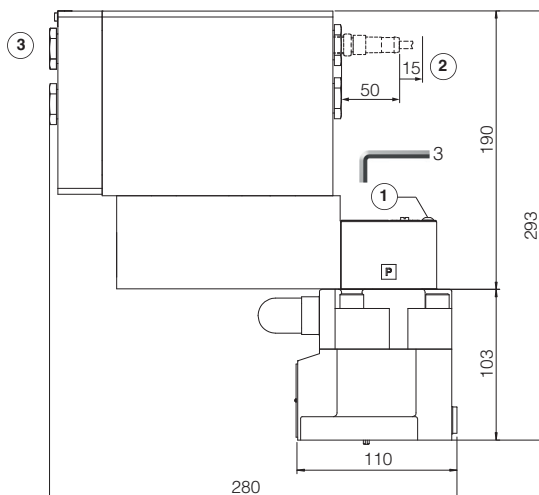

**AGMZA-AES-\*-20**

ISO 6264: 2007  
 Mounting surface: 6264-08-13-1-97  
 (see table P005)

Mass [kg]	
AGMZA-AES-*-20	12,8

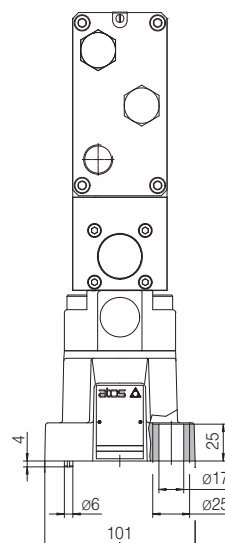
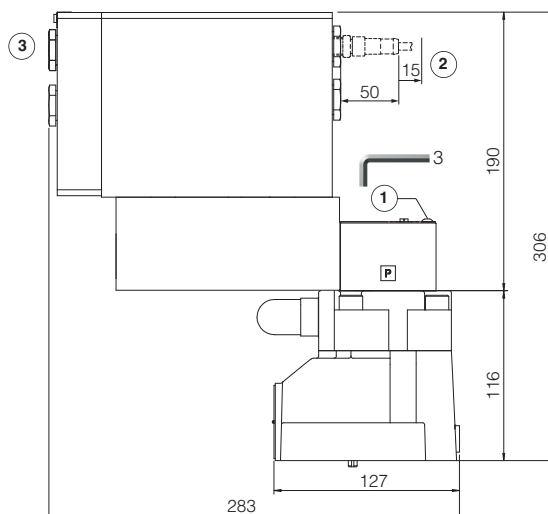

**AGMZA-AES-\*-32**

ISO 6264: 2007  
 Mounting surface: 6264-10-17-1-97  
 (see table P005)

Mass [kg]	
AGMZA-AES-*-32	14,8

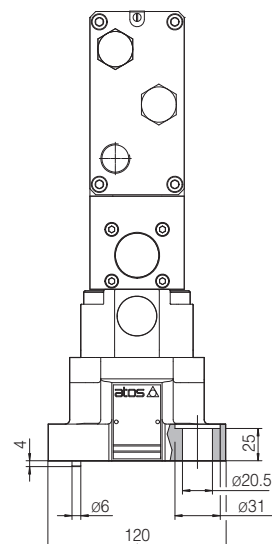
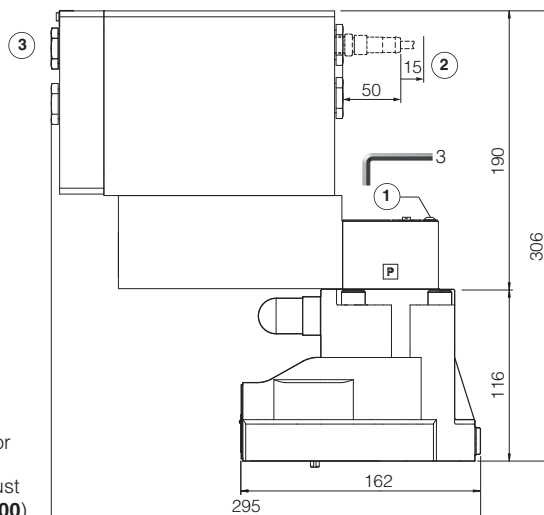

- ① = Air bleed off
- ② = Space to remove the USB connector
- ③ = The dimensions of cable glands must be considered (see tech table **KX800**)

28 RELATED DOCUMENTATION

<b>X010</b> Basics for electrohydraulics in hazardous environments	<b>GS510</b> Fieldbus
<b>X020</b> Summary of Atos ex-proof components certified to ATEX, IECEx, EAC, CCC, PESO	<b>KX800</b> Cable glands for ex-proof valves
<b>FX900</b> Operating and maintenance information for ex-proof proportional valves	<b>P005</b> Mounting surfaces for electrohydraulic valves
<b>GS500</b> Programming tools	