

Proportional directional valves

direct, without transducer

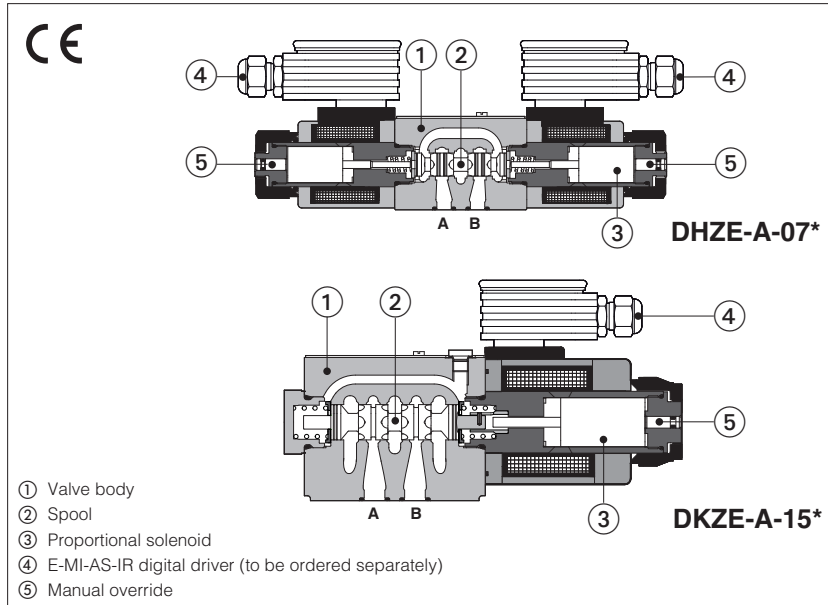

DHZE-A, DKZE-A

Proportional directional valves without position transducer and with positive spool overlap, for open loop directional controls and not compensated flow regulations.

They operate in association with off-board driver, which supply the proportional valves with proper current to align the valve regulation to the reference signal supplied to the driver.

Spool regulation characteristics:

- L = linear
- S = progressive
- D = differential-progressive

Valve body characteristics:
3 chambers type for DHZE
5 chambers type for DKZE

The solenoids are certified according to North American standard **cURus**.

DHZE:	DKZE:
Size: 06 - ISO 4401	Size: 10 - ISO 4401
Max flow: 65 l/min	Max flow: 130 l/min
Max pressure: 350 bar	Max pressure: 315 bar

1 MODEL CODE

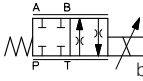
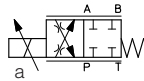
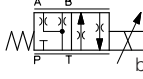
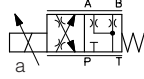
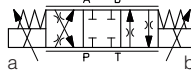
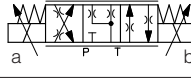
DHZE	-	A	-	0	71	-	S	/	5	/	*	-	*	/	*	/	*		
DHZE = size 06 DKZE = size 10		A = for off-board driver, see section 2		Valve size ISO 4401: 0 = 06 1 = 10		Configuration: Standard Option /B		51 =  		53 =  		71 = 		73 = 		Seals material, see section 7: - = NBR PE = FKM BT = HNBR		Coil voltage, see section 10: - = standard coil for 24 VDC Atos drivers 6 = optional coil for 12 VDC Atos drivers 18 = optional coil for low current drivers	

Coil with special connectors, see section 12:

- = omit for standard DIN connector
- J** = AMP Junior Timer connector
- K** = Deutsch connector
- S** = Lead Wire connection



Hydraulic options:

B = solenoid at side of port A (only for valve configuration 5)

Hand lever options (1):

- MO** = horizontal hand lever
- MV** = vertical hand lever
- BMO** = horizontal hand lever installed at side of port A
- BMV** = vertical hand lever installed at side of port A

Spool type, regulating characteristics:

L = linear	S = progressive	D = differential-progressive
		
P-A = Q, B-T = Q/2 P-B = Q/2, A-T = Q		

Spool size:	14 (L)	1 (L)	3 (L,S,D)	5 (L,S,D)	9 (L)
DHZE =	1	4,5	17	28	45
DKZE =	-	-	45	60	-

Nominal flow (l/min) at Δp 10 bar P-T

(1) Only for **DHZE** with spool type S3, S5, D3, D5, L3, L5

2 OFF-BOARD ELECTRONIC DRIVERS

Drivers model	E-MI-AC-01F		E-MI-AS-IR		E-BM-AS-PS		E-BM-AES
Type	Analog		Digital				
Voltage supply (VDC)	12	24	12	24	12	24	24
Valve coil option	/6	std	/6	std	/6	std	std
Format	plug-in to solenoid				DIN-rail panel		
Tech table	G010		G020		G030		GS050

3 GENERAL NOTES

Atos digital proportionals valves are CE marked according to the applicable directives (e.g. Immunity and Emission EMC Directive). Installation, wirings and start-up procedures must be performed according to the general prescriptions shown in tech table **FS900** and in the installation notes supply with relevant components.

4 GENERAL CHARACTERISTICS

Assembly position	Any position
Subplate surface finishing to ISO 4401	Acceptable roughness index: Ra ≤ 0,8, recommended Ra 0,4 – Flatness ratio 0,01/100
MTTFd valves according to EN ISO 13849	150 years, see technical table P007
Ambient temperature range	Standard = -20°C ÷ +70°C /PE option = -20°C ÷ +70°C /BT option = -40°C ÷ +60°C
Storage temperature range	Standard = -20°C ÷ +80°C /PE option = -20°C ÷ +80°C /BT option = -40°C ÷ +70°C
Surface protection	Zinc coating with black passivation
Corrosion resistance	Salt spray test (EN ISO 9227) > 200 h
Conformity	CE according to EMC directive 2014/30/EU (Immunity: EN 61000-6-2; Emission: EN 61000-6-3) RoHS Directive 2011/65/EU as last update by 2015/863/EU REACH Regulation (EC) n°1907/2006

5 HYDRAULIC CHARACTERISTICS

Valve model	DHZE					DKZE	
Pressure limits [bar]	ports P, A, B = 350; T = 210					ports P, A, B = 315; T = 210	
Spool type and size	L14	L1	S3, L3, D3	S5, L5, D5	L9	S3, L3, D3	S5, L5, D5
Nominal flow (1) [l/min]							
at Δp = 10 bar (P-T)	1	4,5	18	28	45	45	60
at Δp = 30 bar (P-T)	1,7	8	30	50	65	80	105
max permissible flow	see operating limits, section 8.2						
Response time (2) [ms]	≤ 30					≤ 40	
Hysteresis [%]	5 [% of max regulation]						
Repeatability [%]	± 1 [% of max regulation]						

Note: above performance data refer to valves coupled with Atos electronic drivers, see section 2; the flow regulated by the directional proportional valves is not pressure compensated, thus it is affected by the load variations; to keep constant the regulated flow under different load conditions, modular pressure compensators are available - see tech. table D150

(1) For different Δp, the max flow is in accordance to the diagrams in sections 8.2 and 9.2

(2) 0-100% step signal

6 ELECTRICAL CHARACTERISTICS

Valve model	DHZE			DKZE		
Coil voltage code	standard	option /6	option /18	standard	option /6	option /18
Max. solenoid current	2,7 A	3 A	1,2 A	2,2 A	2,65 A	1 A
Coil resistance R at 20°C	3,1 Ω	2,1 Ω	13,1 Ω	3,2 Ω	2,1 Ω	13,7 Ω
Insulation class	H (180°) Due to the occurring surface temperatures of the solenoid coils, the European standards ISO 13732-1 and EN982 must be taken into account					
Protection degree to DIN EN60529	IP65 with mating connectors					
Duty factor	Continuous rating (ED=100%)					
Certification	cURus North American Standard					

7 SEALS AND HYDRAULIC FLUIDS - for other fluids not included in below table, consult our technical office

Seals, recommended fluid temperature	NBR seals (standard) = -20°C ÷ +80°C, with HFC hydraulic fluids = -20°C ÷ +50°C FKM seals (/PE option) = -20°C ÷ +80°C HNBR seals (/BT option) = -40°C ÷ +60°C, with HFC hydraulic fluids = -40°C ÷ +50°C		
Recommended viscosity	20 ÷ 100 mm ² /s - max allowed range 15 ÷ 380 mm ² /s		
Max fluid contamination level	normal operation	ISO4406 class 18/16/13 NAS1638 class 7	see also filter section at www.atos.com or KTF catalog
	longer life	ISO4406 class 16/14/11 NAS1638 class 5	
Hydraulic fluid	Suitable seals type	Classification	Ref. Standard
Mineral oils	NBR, FKM, HNBR	HL, HLP, HLPD, HVLP, HVLPD	DIN 51524
Flame resistant without water	FKM	HFDU, HFDR	ISO 12922
Flame resistant with water	NBR, HNBR	HFC	

8 DIAGRAMS FOR DHZE (based on mineral oil ISO VG 46 at 50 °C)

8.1 Regulation diagrams

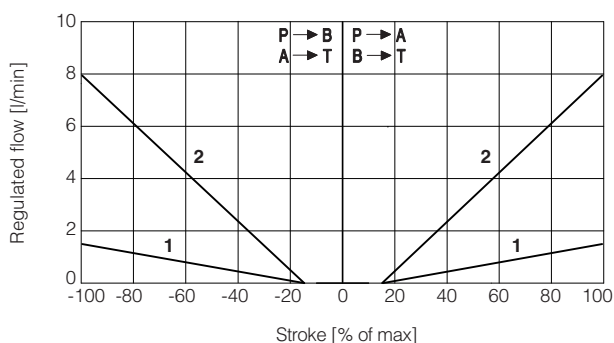

DHZE
1 = L14 2 = L1

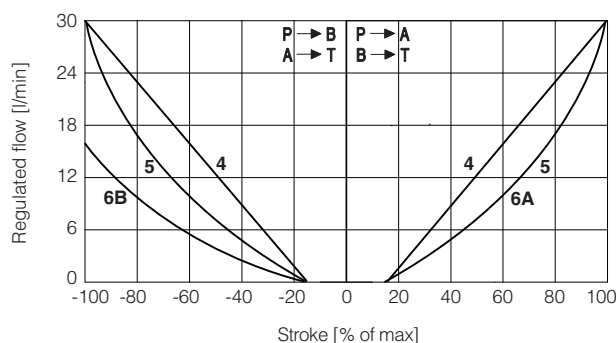

DHZE
4 = L3 5 = S3
6A = D3 (P → A, A → T)
6B = D3 (P → B, B → T)

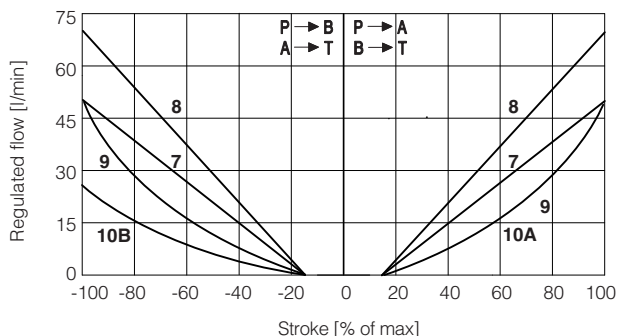

DHZE
7 = L5 8 = L9 9 = S5
10A = D5 (P → A, A → T)
10B = D5 (P → B, B → T)

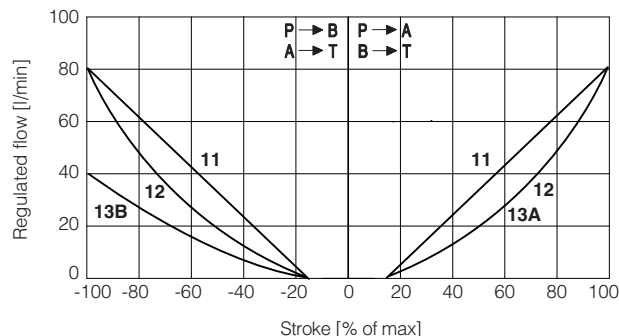

DKZE
11 = L3 12 = S3
13A = D3 (P → A, A → T)
13B = D3 (P → B, B → T)

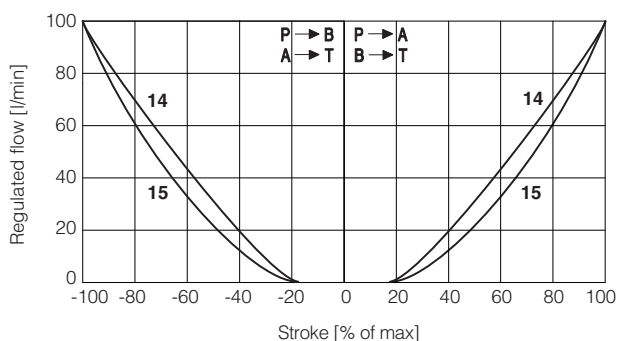

DKZE
14 = L5 15 = S5

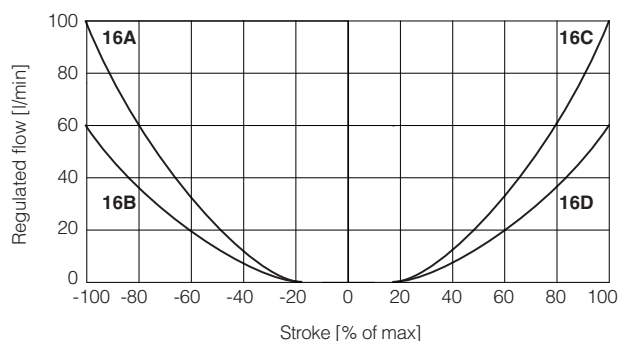

DKZE
16A = D5 (A → T) 16B = D5 (P → B)
16C = D5 (P → A) 16D = D5 (B → T)

Note: Hydraulic configuration vs. reference signal for configuration 71 and 73 (standard and option /B)

Reference signal $\left. \begin{matrix} 0 \div +10 \text{ V} \\ 12 \div 20 \text{ mA} \end{matrix} \right\} P \rightarrow A / B \rightarrow T$

Reference signal $\left. \begin{matrix} 0 \div -10 \text{ V} \\ 12 \div 4 \text{ mA} \end{matrix} \right\} P \rightarrow B / A \rightarrow T$

8.2 Operating limits

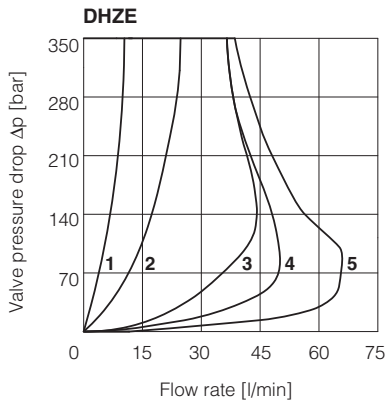

- 1 = spool L14
- 2 = spool L1
- 3 = spool L3, S3, D3
- 4 = spool L5, S5, D5
- 5 = spool L9

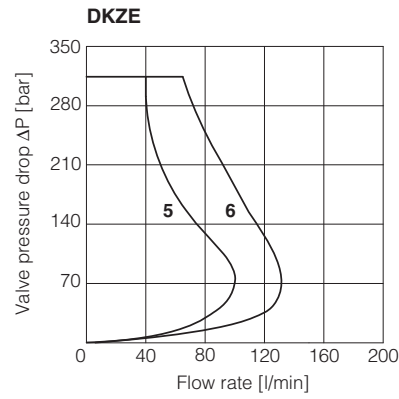

- 5 = spool S3, L3, D3
- 6 = spool S5, L5, D5

9 HYDRAULIC OPTIONS

B = DHZE-05 and DKZE-15 = solenoid at side of port A of the main stage.
 DHZO-07 and DKZE-17 = E-MI-AS-IR electronics at side of port A of the main stage.

Hand lever option - only for DHZE with spool type S3, S5, D3, D5, L3, L5.

It allows to operate the valve in absence of electrical power supply.

For detailed description of DHZE with hand lever option see tech. table **E138**.

MO = Horizontal hand lever

BMO = Horizontal hand lever installed at side of port A

MV = Vertical hand lever

BMV = Vertical hand lever installed at side of port A

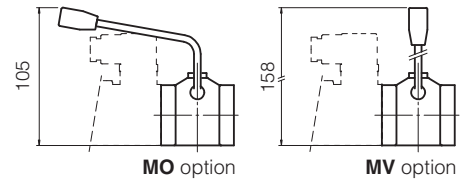

10 COIL VOLTAGE OPTIONS

6 = Optional coil to be used with Atos drivers with power supply 12 VDC.

18 = Optional coil to be used with electronic drivers not supplied by Atos.

11 OPERATION AS THROTTLE VALVE

Single solenoid valves
 DHZE-A-051 and DKZE-A-151
 can be used as simple throttle valves:
 $P_{max} = 210 \text{ bar}$

Max flow $\Delta p = 15 \text{ bar}$ [l/min]	SPOOL TYPE					
	L14	L1	L3	S3	L5	S5
DHZE	4	16	60		100	
DKZE	-	-	160		200	

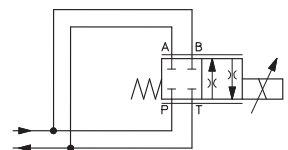

12 COILS WITH SPECIAL CONNECTORS

J option

Coil type COZEJ (DHZE)
 Coil type CAZEJ (DKZE)
 AMP Junior Timer connector
 Protection degree IP67

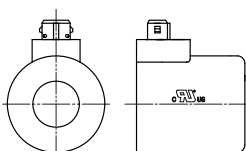

K option

Coil type COZEK (DHZE)
 Coil type CAZEK (DKZE)
 Deutsch connector, DT-04-2P male
 Protection degree IP67

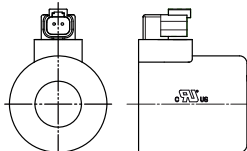

S option

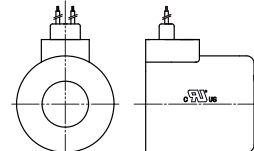

Coil type COZES (DHZE)
 Coil type CAZES (DKZE)
 Lead Wire connection
 Cable length = 180 mm

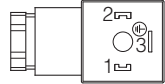

13 SOLENOID CONNECTION

PIN	SIGNAL	TECHNICAL SPECIFICATION	Connector code 666 
1	COIL	Power supply	
2	COIL	Power supply	
3	GND	Ground	

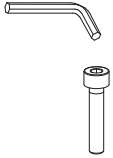
14 FASTENING BOLTS AND SEALS

	DHZE	DKZE
	Fastening bolts: 4 socket head screws M5x30 class 12.9 Tightening torque = 8 Nm	Fastening bolts: 4 socket head screws M6x40 class 12.9 Tightening torque = 15 Nm
	Seals: 4 OR 108 Diameter of ports A, B, P, T: Ø 7,5 mm (max)	Seals: 5 OR 2050 Diameter of ports A, B, P, T: Ø 11,2 mm (max)

15 INSTALLATION DIMENSIONS FOR DHZE [mm]

ISO 4401: 2005
 Mounting surface: 4401-03-02-0-05 (see table P005)

Mass [kg]	
DHZE-A-05	1,5
DHZE-A-07	2
DHZE-A-05 with E-MI-AS-IR	2
DHZE-A-07 with E-MI-AS-IR	3

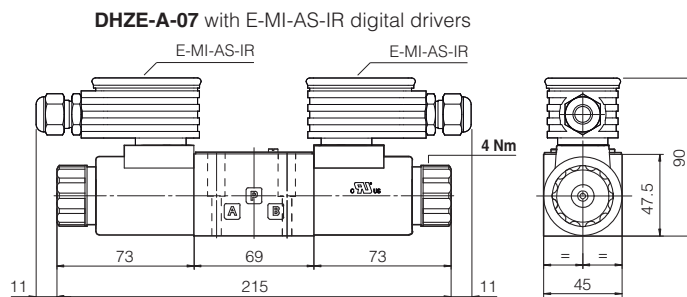
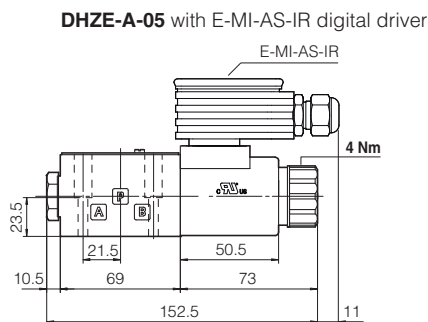
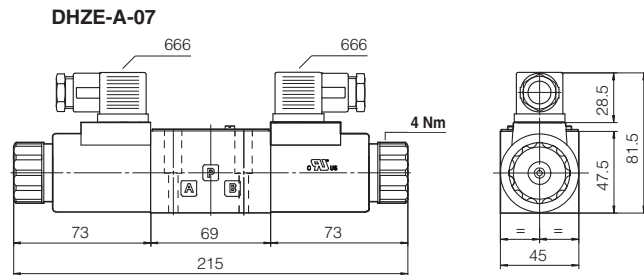
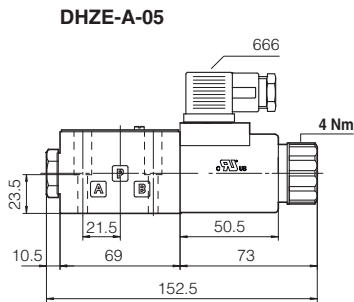

Note: for option /B the solenoid is at side of port A (only for DHZE-A-05 and DKZE-A-15)

16 INSTALLATION DIMENSIONS FOR DKZE [mm]

ISO 4401: 2005
 Mounting surface: 4401-05-04-0-05 (see table P005)

Mass [kg]	
DKZE-A-15	4,5
DKZE-A-17	6,1
DKZE-A-15 with E-MI-AS-IR	5
DKZE-A-17 with E-MI-AS-IR	7,1

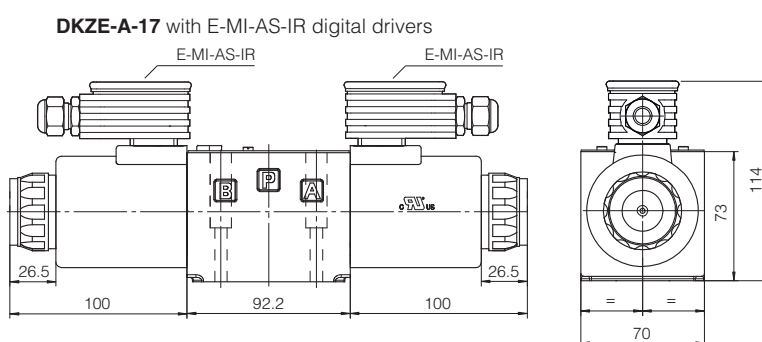
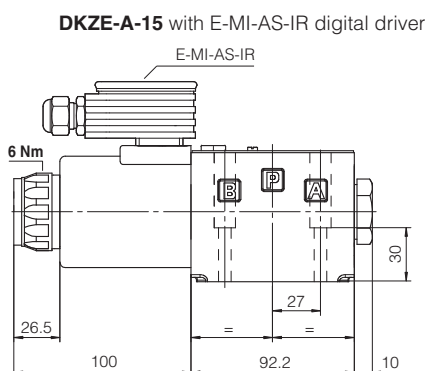
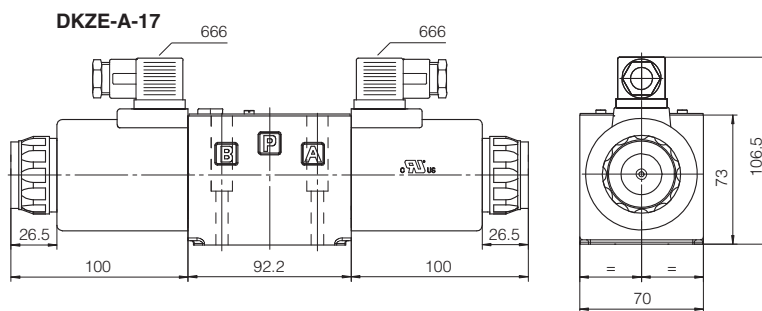
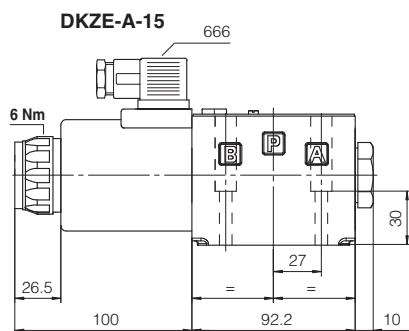

Note: for option /B the solenoid is at side of port A (only for DHZE-A-05 and DKZE-A-15)

17 RELATED DOCUMENTATION

FS001	Basics for digital electrohydraulics	GS500	Programming tools
FS900	Operating and maintenance information for proportional valves	GS510	Fieldbus
G010	E-MI-AC analog driver	K800	Electric and electronic connectors
G020	E-MI-AS-IR digital driver	P005	Mounting surfaces for electrohydraulic valves
G030	E-BM-AS digital driver		
GS050	E-BM-AES digital driver		