

Proportional directional valves

piloted, without transducer, with positive spool overlap

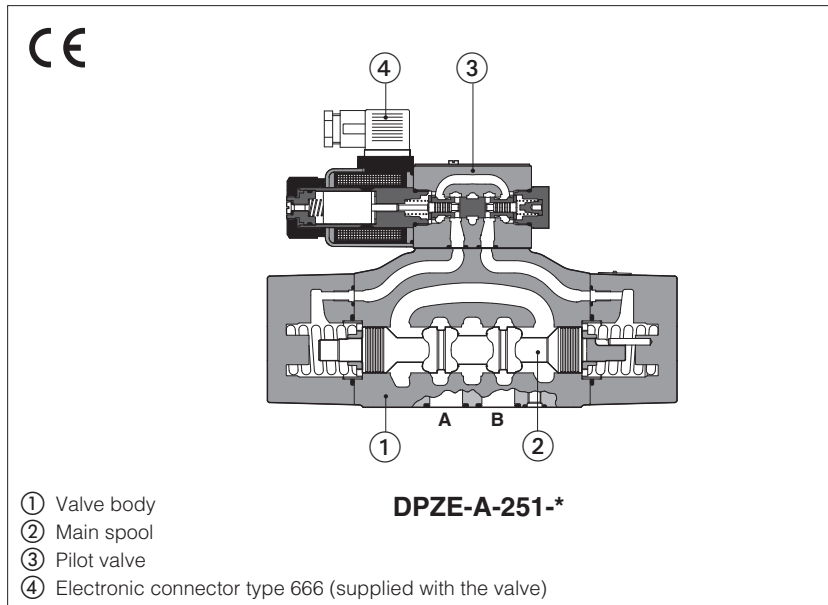

DPZE-A

Piloted proportional valves without position transducer and with positive spool overlap, for open loop directional controls and not compensated flow regulations.

They operate in association with electronic drivers, see section 2, which supply the proportional valve with proper current to align the hydraulic regulation to the reference signal.

The solenoid are certified according to North American standards cURus.

Mounting surface: **ISO 4401**

Size: **10 ÷ 32** - ISO 4401

Max flow: **180 ÷ 1500 l/min**

Max pressure: **350 bar**

1 MODEL CODE

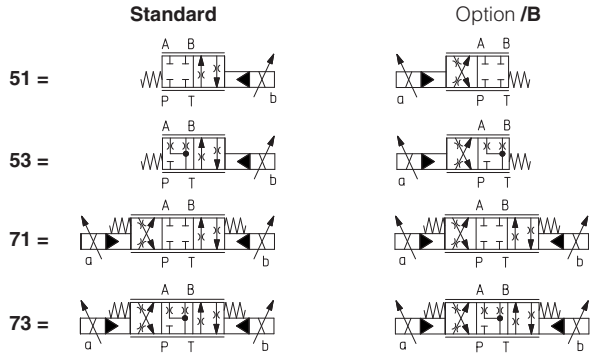
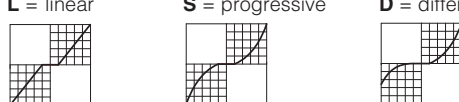
DPZE	-	A	-	2	71	-	L	5	/	*	-	*	/	*	/	*	/	*
Proportional directional valve, piloted A = for off-board driver, see section 2 Valve size ISO 4401: 1 = 10 2 = 16 4 = 25 6 = 32 Configuration: Standard Option /B  51 = a a 53 = a a 71 = a a 73 = a a Spool type - regulating characteristics: L = linear S = progressive D = differential-progressive  P-A = Q, B-T = Q/2 P-B = Q/2, A-T = Q Seals material, see sect. 7: - = NBR PE = FKM BT = HNBR Series number Coil voltage , see section 2, 6: - = standard coil for 24V _{dc} Atos drivers 6 = optional coil for 12V _{dc} Atos drivers 18 = optional coil for low current drivers (2) Coils with special connectors, see section 11: - = omit for standard DIN connector J = AMP Junior Timer connector K = Deutsch connector S = Lead Wire connection Hydraulic options , see sect. 9: B = solenoid at side of port B of the main stage (side A of pilot valve) (1) - only for configuration 51 and 53 D = internal drain E = external pilot pressure G = pressure reducing valve for piloting Spool size: 3 (L,S,D) 5 (L,S,D) DPZE-1 = - 100 DPZE-2 = 160 250 DPZE-4 = - 480 DPZE-6 = - 640 Nominal flow (l/min) at Δp 10bar P-T																		

(1) In standard configuration the solenoid (config. 51 and 53) is at side A of the main stage (side B of pilot valve)
 (2) Select valve's coil voltage /18 in case of electronic drivers not supplied by Atos, with power supply 24V_{dc} and with max current limited to 1A.

2 OFF-BOARD ELECTRONIC DRIVERS

Drivers model	E-MI-AC-01F		E-MI-AS-IR		E-BM-AS-PS		E-BM-AES
Type	Analog		Digital				
Voltage supply (VDC)	12	24	12	24	12	24	24
Valve coil option	/6	std	/6	std	/6	std	std
Format	plug-in to solenoid				DIN-rail panel		
Tech table	G010		G020		G030		GS050

3 GENERAL NOTES

Atos digital proportionals valves are CE marked according to the applicable directives (e.g. Immunity and Emission EMC Directive). Installation, wirings and start-up procedures must be performed according to the general prescriptions shown in tech table **FS900** and in the installation notes supplied with relevant components.

4 GENERAL CHARACTERISTICS

Assembly position	Any position
Subplate surface finishing to ISO 4401	Acceptable roughness index: Ra ≤ 0,8, recommended Ra 0,4 – Flatness ratio 0,01/100
MTTFd valves according to EN ISO 13849	75 years, see technical table P007
Ambient temperature range	Standard = -20°C ÷ +70°C /PE option = -20°C ÷ +70°C /BT option = -40°C ÷ +60°C
Storage temperature range	Standard = -20°C ÷ +80°C /PE option = -20°C ÷ +80°C /BT option = -40°C ÷ +70°C
Surface protection	Zinc coating with black passivation
Corrosion resistance	Salt spray test (EN ISO 9227) > 200 h
Compliance	CE according to EMC directive 2014/30/EU (Immunity: EN 61000-6-2; Emission: EN 61000-6-3) RoHS Directive 2011/65/EU as last update by 2015/863/EU REACH Regulation (EC) n°1907/2006

5 HYDRAULIC CHARACTERISTICS - based on mineral oil ISO VG 46 at 50 °C

Valve model	DPZE-*-1	DPZE-*-2	DPZE-*-4	DPZE-*-6	
Pressure limits [bar]	ports P, A, B, X = 350; T = 250 (10 with internal drain /D) Y = 10				
Spool type	L5, S5, D5	L3, S3, D3	L5, S5, D5		
Nominal flow Δp P-T [l/min] (1)					
Δp= 10 bar	100	160	250	480	640
Δp= 30 bar	160	270	430	830	1100
Max permissible flow	180	400	550	900	1500
Piloting pressure [bar]	min = 25; max = 350 (option /G advisable for pilot pressure > 150 bar)				
Piloting volume [cm³]	1,4	3,7	9,0	21,6	
Piloting flow (2) [l/min]	1,7	3,7	6,8	14,4	
Leakage (3) [l/min]	0,15 / 0,5	0,2 / 0,6	0,3 / 1,0	1,0 / 3,0	
Response time (4) [ms]	≤ 80	≤ 100	≤ 120	≤ 180	
Hysteresis	≤ 5 [% of max regulation]				
Repeatability	± 1 [% of max regulation]				

Note: above performance data refer to valves coupled with Atos electronic drivers, see section **2**

(1) For different Δp, the max flow is in accordance to the diagrams in section 8.2

(3) At P = 100/350 bar

(2) With step reference input signal 0 ÷ 100 %

(4) 0-100% step signal

6 ELECTRICAL CHARACTERISTICS

	Standard	option /6	option /18
Coil voltage code	standard coil to be used with Atos drivers with power supply 24Vdc	optional coil to be used with Atos drivers with power supply 12 Vdc	optional coil to be used with electronic drivers not supplied by Atos, with power supply 24 Vdc and max current limited to 1A
Max. solenoid current	2,5 A	3 A	1,2 A
Coil resistance R at 20°C	3,1 Ω	2,1 Ω	13,1 Ω
Insulation class	H (180°) Due to the occurring surface temperatures of the solenoid coils, the European standards ISO 13732-1 and EN982 must be taken into account		
Protection degree to DIN EN60529	IP 65 (with connectors 666 correctly assembled)		
Duty factor	Continuous rating (ED=100%)		
Certification	cURus North American Standards		

7 SEALS AND HYDRAULIC FLUID - for other fluids not included in below table, consult our technical office

Seals, recommended fluid temperature	NBR seals (standard) = -20°C ÷ +80°C, with HFC hydraulic fluids = -20°C ÷ +50°C FKM seals (/PE option) = -20°C ÷ +80°C HNBR seals (/BT option) = -40°C ÷ +60°C, with HFC hydraulic fluids = -40°C ÷ +50°C		
Recommended viscosity	20 ÷ 100 mm ² /s - max allowed range 15 ÷ 380 mm ² /s		
Max fluid contamination level	normal operation	ISO4406 class 18/16/13 NAS1638 class 7	see also filter section at www.atos.com or KTF catalog
	longer life	ISO4406 class 16/14/11 NAS1638 class 5	
Hydraulic fluid	Suitable seals type	Classification	Ref. Standard
Mineral oils	NBR, FKM, HNBR	HL, HLP, HLPD, HVLP, HVLPD	DIN 51524
Flame resistant without water	FKM	HFDU, HFDR	ISO 12922
Flame resistant with water	NBR, HNBR	HFC	

8 DIAGRAMS (based on mineral oil ISO VG 46 at 50 °C)

8.1 Regulation diagrams (values measure at Δp 10 bar P-T)

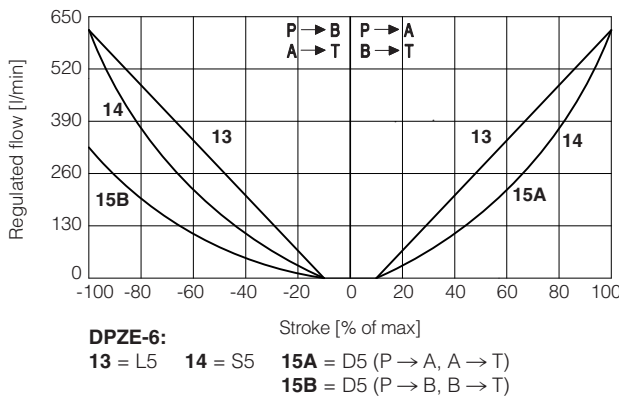
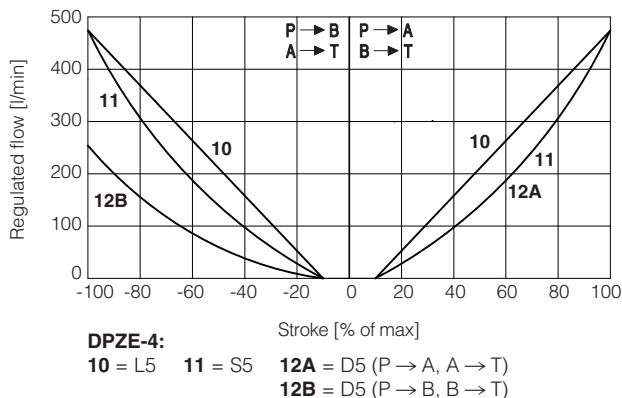
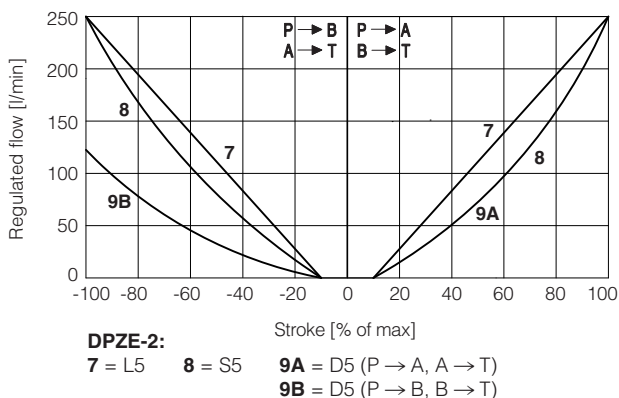
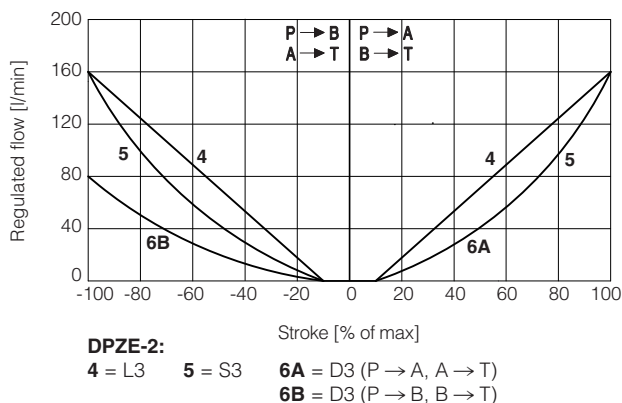
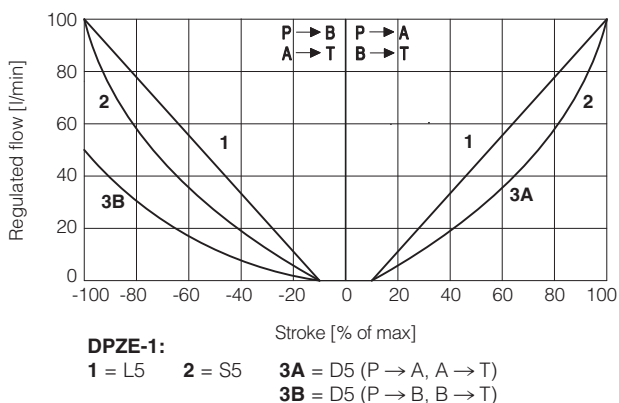

Note: Hydraulic configuration vs. reference signal for configuration 71 and 73 (standard and option /B)

Reference signal $\begin{matrix} 0 \div +10 \text{ V} \\ 12 \div 20 \text{ mA} \end{matrix} \} P \rightarrow A / B \rightarrow T$

Reference signal $\begin{matrix} 0 \div -10 \text{ V} \\ 12 \div 4 \text{ mA} \end{matrix} \} P \rightarrow B / A \rightarrow T$

8.2 Flow / Δp diagram

stated at 100% of spool stroke

DPZE-1:

1 = spools L5, S5, D5

DPZE-2:

2 = spools L3, S3, D3

3 = spools L5, S5, D5

DPZE-4:

4 = spools L5, S5, D5

DPZE-6:

5 = spools L5, S5, D5

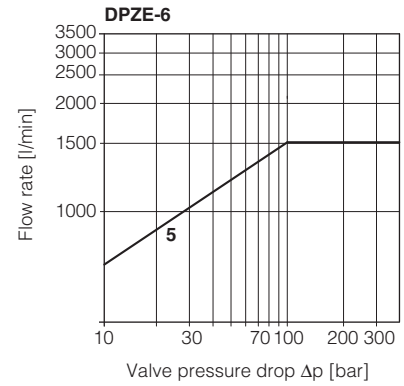
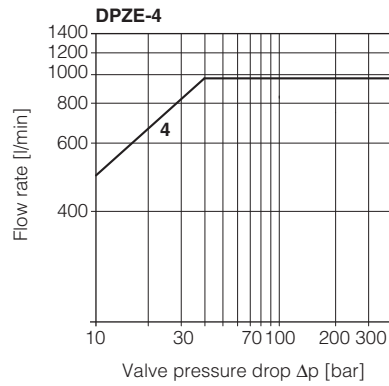
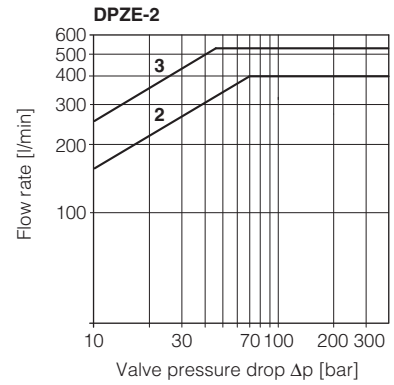
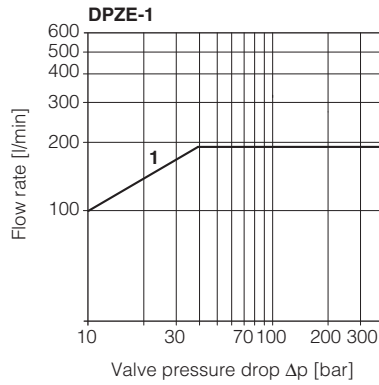

8.3 Response time (measured at pilot pressure = 100 bar)

The response times in below diagrams are measured at different steps of the reference input signal. They have to be considered as average values. For the valves with digital electronics the dynamics performances can be optimized by setting the internal software parameters.

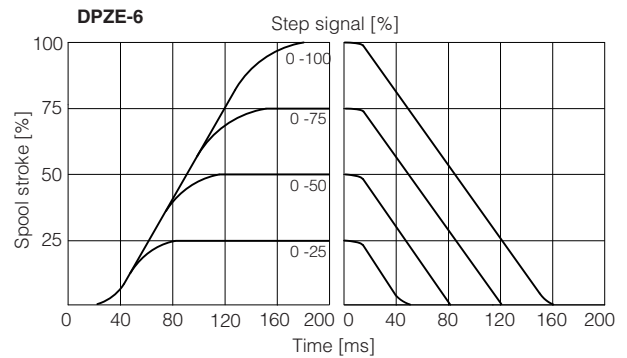
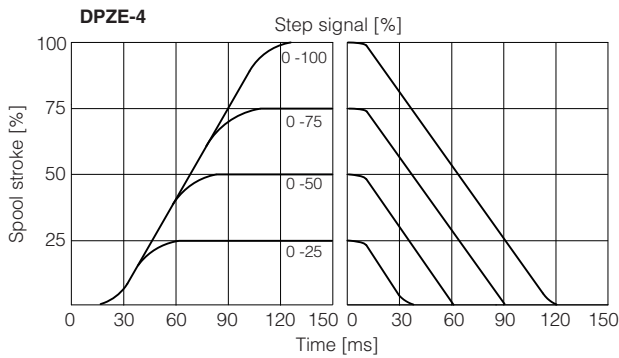
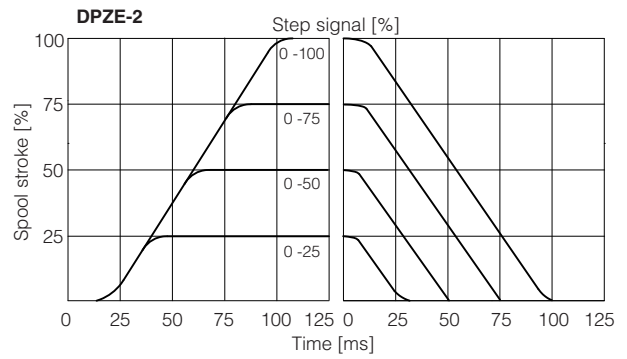
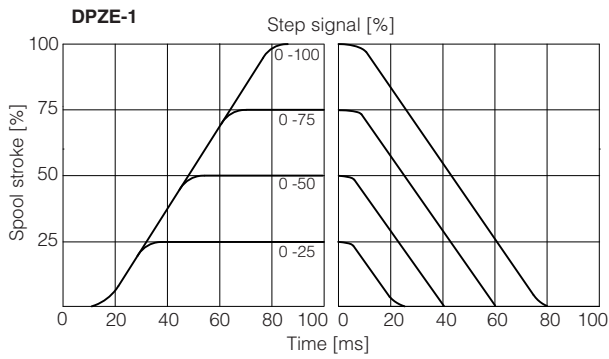

8.4 Operation as throttle valve

Single solenoid valves (*51) can be used as simple throttle valves:
 $P_{max} = 250 \text{ bar}$

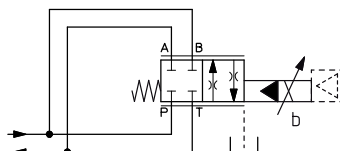

DPZE-A-	151-L5	251-L5	451-L5	651-L5
Max flow [l/min]	320	860	1600	2200
$\Delta p = 15 \text{ bar}$				

9 HYDRAULIC OPTIONS

B = solenoid at side B of the main stage (side A of pilot valve).

D = Internal drain.

Pilot and drain configuration can be modified as shown in section 12.

The valve's standard configuration provides internal pilot and external drain.

E = External pilot (through port X).

Pilot and drain configuration can be modified as shown in section 12.

The valve's standard configuration provides internal pilot and external drain.

G = Pressure reducing valve installed between pilot valve and main body with fixed setting:

DPZE-1 and DPZE-2 = **30 bar**

DPZE-4 and DPZE-6 = **40 bar**

It is advisable for valves with internal pilot in case of system pressure higher than 150 bar.

Functional Scheme

Example of configuration 7*

3 positions, spring centered

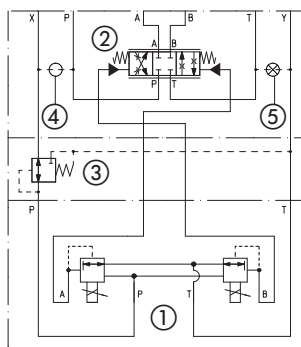

- ① Pilot valve
- ② Main stage
- ③ Pressure reducing valve
- ④ Plug to be added for external pilot trough port X
- ⑤ Plug to be removed for internal drain through port T

10 SOLENOID CONNECTION

PIN	SIGNAL	TECHNICAL SPECIFICATION	Connector code 666
1	COIL	Power supply	
2	COIL	Power supply	
3	GND	Ground	

11 COILS WITH SPECIAL CONNECTORS

Options -J

Coil type COZEJ
AMP Junior Timer connector
Protection degree IP67

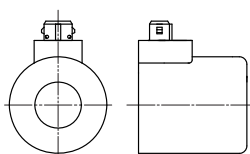

Options -K

Coil type COZEK
Deutsch connector, DT-04-2P male
Protection degree IP67

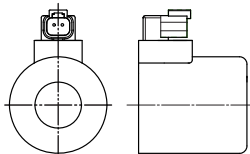

Options -S

Coil type COZES
Lead Wire connection
Cable lenght = 180 mm

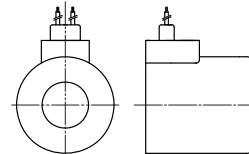

12 PLUGS LOCATION FOR PILOT/DRAIN CHANNELS

Depending on the position of internal plugs, different pilot/drain configurations can be obtained as shown below. To modify the pilot/drain configuration, proper plugs must only be interchanged. The plugs have to be sealed using loctite 270. Standard valves configuration provides internal pilot and external drain

DPZE-1 Pilot channels

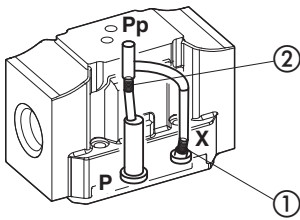

Drain channels

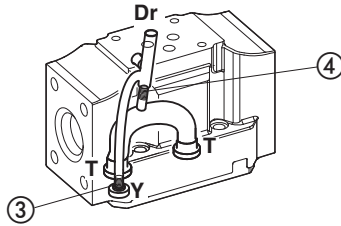

Internal piloting: blinded plug SP-X300F ① in X;
External piloting: blinded plug SP-X300F ② in Pp;
Internal drain: blinded plug SP-X300F ③ in Y;
External drain: blinded plug SP-X300F ④ in Dr.

DPZE-2 Pilot channels

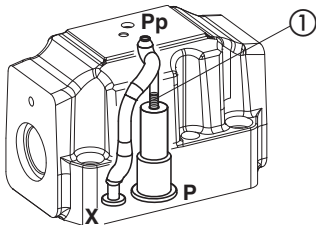

Drain channels

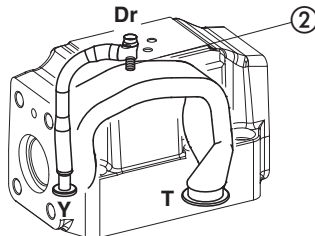

Internal piloting: Without blinded plug SP-X300F ①;
External piloting: Add blinded plug SP-X300F ①;
Internal drain: Without blinded plug SP-X300F ②;
External drain: Add blinded plug SP-X300F ②.

DPZE-4 Pilot channels

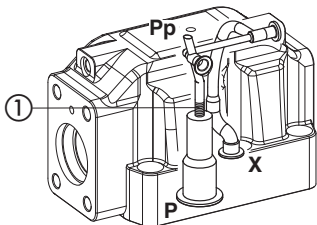

Drain channels

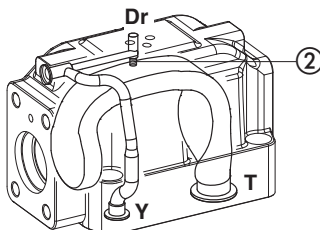

Internal piloting: Without blinded plug SP-X500F ①;
External piloting: Add blinded plug SP-X500F ①;
Internal drain: Without blinded plug SP-X300F ②;
External drain: Add blinded plug SP-X300F ②.

DPZE-6 Pilot channels

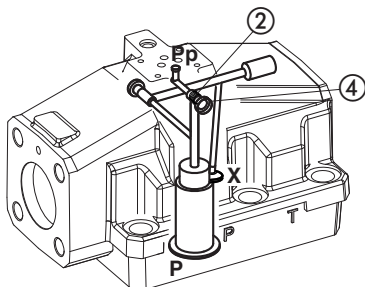

Pilot channels

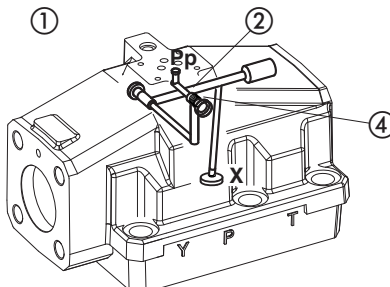

Drain channels

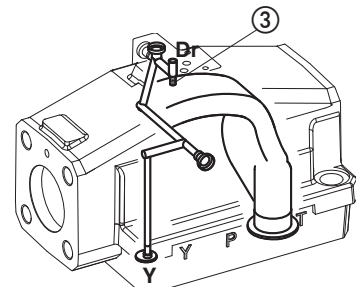

Internal piloting:
 plug SP-X325A in pos ②;

External piloting:
 plug SP-X325A in pos ②;

Internal drain:
 Without blinded plug SP-X300F ③;

External drain:
 Add blinded plug SP-X300F ③.

To reach the orifice ②, remove plug ④ = G 1/8"

13 FASTENING BOLTS AND SEALS

Type	Size	Fastening bolts	Seals
DPZE	1 = 10	4 socket head screws M6x40 class 12.9 Tightening torque = 15 Nm	5 OR 2050; Diameter of ports A, B, P, T: \varnothing 11 mm (max) 2 OR 108 Diameter of ports X, Y: \varnothing = 7 mm (max)
	2 = 16	4 socket head screws M10x50 class 12.9 Tightening torque = 70 Nm 2 socket head screws M6x45 class 12.9 Tightening torque = 15 Nm	4 OR 130; Diameter of ports A, B, P, T: \varnothing 20 mm (max) 2 OR 2043 Diameter of ports X, Y: \varnothing = 9 mm (max)
	4 = 25	6 socket head screws M12x60 class 12.9 Tightening torque = 125 Nm	4 OR 4112; Diameter of ports A, B, P, T: \varnothing 25 mm (max) 2 OR 3056 Diameter of ports X, Y: \varnothing = 11.5 mm (max)
	6 = 32	6 socket head screws M20x80 class 12.9 Tightening torque = 600 Nm	4 OR 144; Diameter of ports A, B, P, T: \varnothing 34 mm (max) 2 OR 3056 Diameter of ports X, Y: \varnothing = 7 mm (max)

14 INSTALLATION DIMENSIONS [mm]

DPZE-1*

ISO 4401: 2005

Mounting surface: 4401-05-05-0-05

(see table P005)

Mass [kg]

	A
DPZE-*-25*	6,9
DPZE-*-27*	7,3
Option /G	+0,9

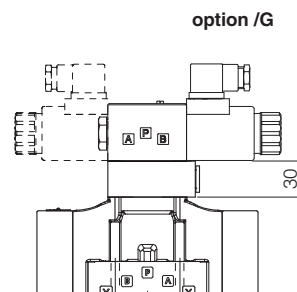
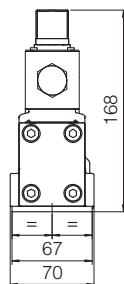
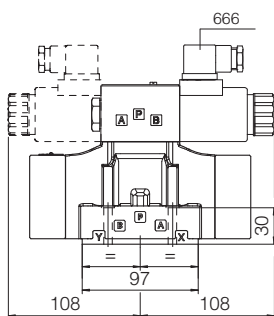

DPZE-2*

ISO 4401: 2005

Mounting surface: 4401-07-07-0-05
(see table P005)

Mass [kg]

	A
DPZE*-25*	11,9
DPZE*-27*	12,8
Option /G	+0,9

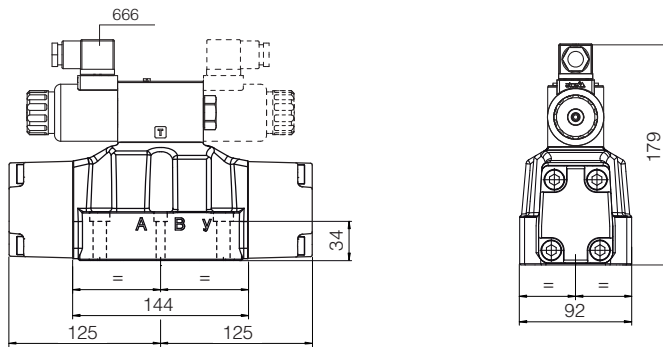

Option /G

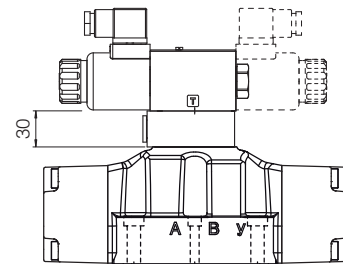

DPZE-4*

ISO 4401: 2005

Mounting surface: 4401-08-08-0-05
(see table P005)

Mass [kg]

	A
DPZE*-45*	17,1
DPZE*-47*	18
Option /G	+0,9

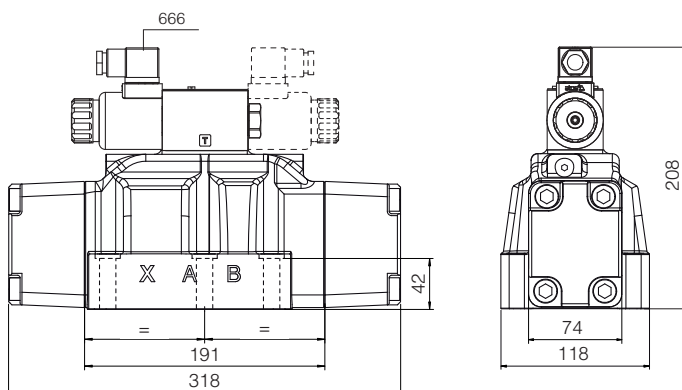

Option /G

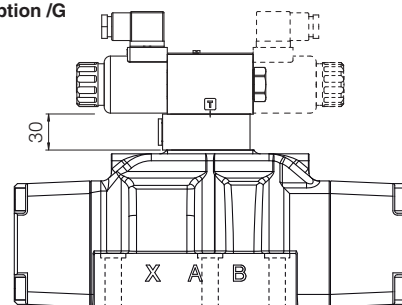

Dotted line = double solenoid version

DPZE-6*

ISO 4401: 2005

Mounting surface: 4401-10-09-0-05
(see table P005)

Mass [kg]

	A
DPZE-*-65*	44
DPZE-*-67*	44,5
Option /G	+1

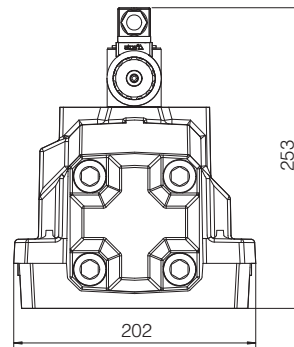
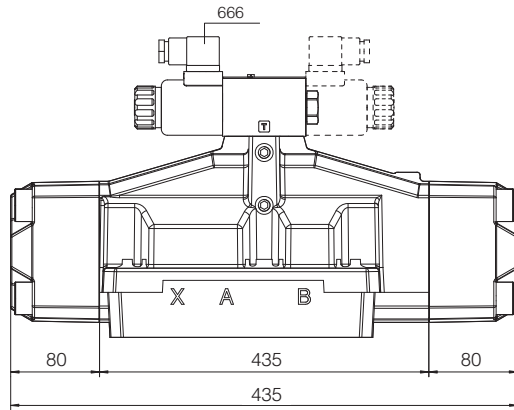

Option /G

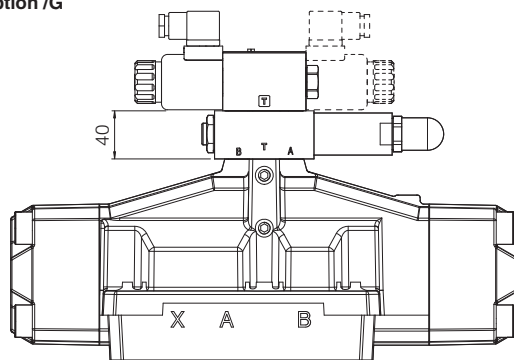

Dotted line = double solenoid version