

# Proportional directional valves high performance

piloted, with two LVDT transducers and positive spool overlap

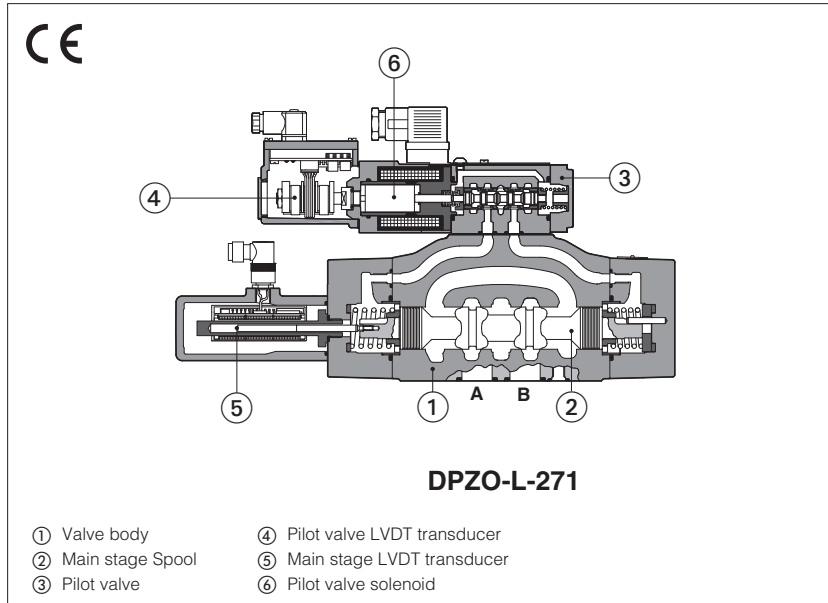

## DPZO-L

Proportional directional valves, piloted, with two LVDT position transducers and positive spool overlap for best dynamics in directional controls and not compensated flow regulations.

The valves operate in association with digital off-board drivers, see section 3.

The two LVDT transducers (pilot and main stage) grant very high regulation accuracy and response sensitivity.

With de-energized proportional solenoids, mechanical central position of the spool is performed by centering springs

Spools regulation characteristics:

L = linear

S = progressive for fine low flow control

D and DL = differential, for control of actuators with area ratio 1:2

D9 and L9 = for regenerative circuit

Q5 and V9 = for alternate P/Q control

Size: 10 ÷ 32 - ISO 4401

Max flow: 180 ÷ 1600 l/min

Max pressure: 350 bar

### 1 MODEL CODE OF STANDARD SPOOLS

<b>DPZO</b>	-	<b>L</b>	-	<b>2</b>		<b>71</b>	-	<b>L</b>		<b>5</b>	/	<b>*</b>		<b>*</b>	/	<b>*</b>				
<p>Proportional directional valve, piloted</p> <p>L = two LVDT transducers</p> <p>Valve size ISO 4401: 1 = 10 2 = 16 4 = 25 4M = 27 6 = 32</p> <p>Configuration:</p> <table border="0"> <tr> <td style="text-align: center;"><b>Standard</b></td> <td style="text-align: center;"><b>Option /B</b></td> </tr> <tr> <td style="text-align: center;"> </td> <td style="text-align: center;"> </td> </tr> </table> <p><b>Seals material</b>, see section 7:</p> <ul style="list-style-type: none"> <li>- = NBR</li> <li>PE = FKM</li> <li>BT = NBR low temperature</li> </ul> <p>Series number</p>																	<b>Standard</b>	<b>Option /B</b>		
<b>Standard</b>	<b>Option /B</b>																			

### Configuration:

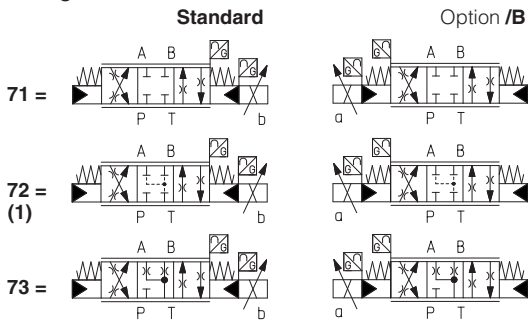

### Spool type, regulating characteristics (2):

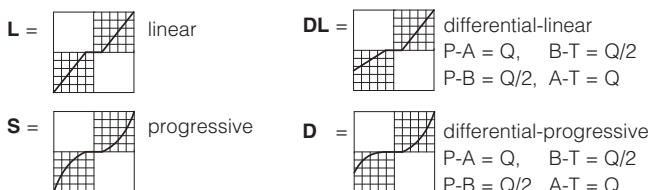

(1) Only for DPZO sizes 2, 4, 4M with spools L5, S5 or D5: in central position the leakages P-A and P-B are drained to tank, avoiding the drift of cylinders with differential areas

### Hydraulic options (3):

**B** = solenoid and LVDT transducer at side of port B of the main stage (side A of pilot valve)

**D** = internal drain

**E** = external pilot pressure

**G** = pressure reducing valve for piloting

Spool size:	3	5	5	5
Spool type:	L, S, D	L, DL, S, D	L, S, D	L, S, D5
Configuration:	71, 73	71, 73	71, 73	72
DPZO-1 =	-	100	-	-
DPZO-2 =	160	250	-	250
DPZO-4 =	-	480	-	480
DPZO-4M =	-	550	-	550
DPZO-6 =	-	-	640	-
Nominal flow (l/min) at Δp 10bar P-T				

(2) Spools for regenerative circuit or alternated P/Q control, see section 2

(3) All combination possible

**2 MODEL CODE OF SPOOLS FOR REGENERATIVE CIRCUIT OR ALTERNATED P/Q CONTROL** - for valve model code and options, see sect. 1

**DPZO** - **L** - **2** **71 - L9** / \* \* \*

**Configuration and spool for regenerative circuit:**

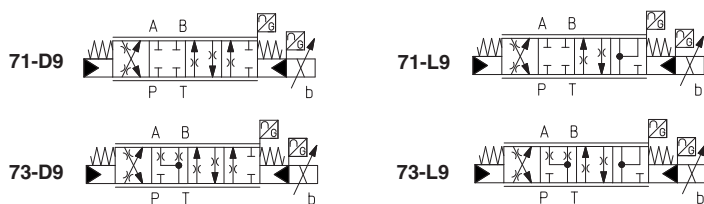

**Configuration and spool for alternated P/Q control:**

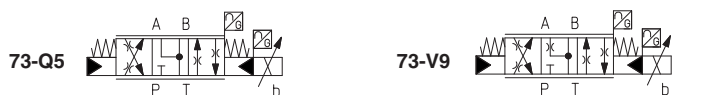

Spool size:	D9	L9	V9	Q5
DPZO-1 =	100	-	100	100
DPZO-2 =	250	250	250	250
DPZO-4 =	480	-	480	480
DPZO-4M =	550	-	550	550
DPZO-6 =	-	-	640	-

Nominal flow (l/min) at  $\Delta p$  10bar P-T

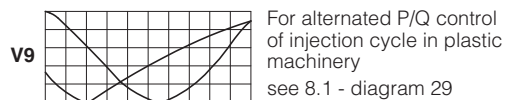
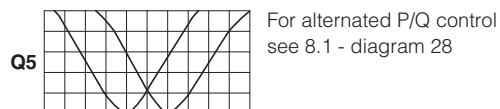
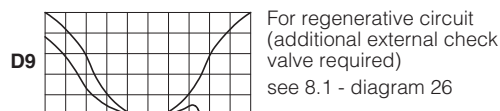

**3 OFF-BOARD ELECTRONIC DRIVERS**

Please include in the driver order also the complete code of the connected proportional valve.

Drivers model	E-BM-LEB	E-BM-LES
Type	digital	digital
Format	DIN-rail panel	DIN-rail panel
Tech table	GS230	GS240

**4 GENERAL CHARACTERISTICS**

Assembly position	Any position
Subplate surface finishing to ISO 4401	Acceptable roughness index: $Ra \leq 0,8$ , recommended $Ra 0,4$ – Flatness ratio 0,01/100
MTTFd valves according to EN ISO 13849	75 years, for further details see technical table P007
Ambient temperature range	<b>Standard</b> = $-20^{\circ}\text{C} \div +60^{\circ}\text{C}$ / <b>PE</b> option = $-20^{\circ}\text{C} \div +60^{\circ}\text{C}$ / <b>BT</b> option = $-40^{\circ}\text{C} \div +60^{\circ}\text{C}$
Storage temperature range	<b>Standard</b> = $-20^{\circ}\text{C} \div +70^{\circ}\text{C}$ / <b>PE</b> option = $-20^{\circ}\text{C} \div +70^{\circ}\text{C}$ / <b>BT</b> option = $-40^{\circ}\text{C} \div +70^{\circ}\text{C}$
Surface protection	Zinc coating with black passivation
Corrosion resistance	Salt spray test (EN ISO 9227) > 200 h
Vibration resistance	See technical table G004
Compliance	CE according to EMC directive 2014/30/EU (Immunity: EN 61000-6-2; Emission: EN 61000-6-3) RoHS Directive 2011/65/EU as last update by 2015/863/EU REACH Regulation (EC) n°1907/2006

**5 HYDRAULIC CHARACTERISTICS** - based on mineral oil ISO VG 46 at 50 °C

Valve model	DPZO-L-1	DPZO-L-2	DPZO-L-4	DPZO-L-4M	DPZO-L-6	
Pressure limits [bar]	ports <b>P, A, B, X</b> = 350; <b>T</b> = 250 (10 for option /D); <b>Y</b> = 10;					
Spool type standard	<b>L5, DL5, S5, D5</b>	<b>L3, S3, D3</b>	<b>L5, DL5, S5, D5</b>		<b>L5, S5, D5</b>	
regenerative or P/Q	<b>D9, V9, Q5</b>		<b>D9, L9, V9, Q5</b>	<b>D9, V9, Q5</b>	<b>V9</b>	
Nominal flow $\Delta p$ P-T [l/min] <b>(1)</b>						
$\Delta p = 10$ bar	100	160	250	480	550	640
$\Delta p = 30$ bar	160	270	430	830	950	1100
Max permissible flow [l/min]	180	400	550	1000	1100	1600
Piloting pressure [bar]	min. = 25; max = 350 (option /G advisable for pilot pressure > 150 bar)					
Piloting volume [cm <sup>3</sup> ]	1,4	3,7	9,0	11,3	21,6	
Piloting flow <b>(2)</b> [l/min]	1,7	3,7	6,8	8	14,4	
Leakage <b>(3)</b> Pilot [cm <sup>3</sup> /min]	100 / 300	100 / 300	200 / 500	200 / 600	900 / 2800	
Main stage [l/min]	0,15 / 0,5	0,2 / 0,6	0,3 / 1,0	0,3 / 1,0	1,0 / 3,0	
Response time <b>(4)</b> [ms]	≤ 50	≤ 60	≤ 80	≤ 85	≤ 90	
Hysteresis	≤ 0,1 [% of max regulation]					
Repeatability	± 0,1 [% of max regulation]					
Thermal drift	zero point displacement < 1% at $\Delta T = 40^\circ C$					

**(1)** For different  $\Delta p$ , the max flow is in accordance to the diagrams in section 8.2

**(3)** At  $p = 100/350$  bar

**(2)** With step reference input signal 0 ÷ 100 %

**(4)** 0-100% step signal see detailed diagrams in section 8.3

**6 ELECTRICAL CHARACTERISTICS**

Max power consumption	30 W
Max. solenoid current	2,6 A
Coil resistance R at 20°C	3 ÷ 3,3 $\Omega$
Insulation class	H (180°) Due to the occurring surface temperatures of the solenoid coils, the European standards ISO 13732-1 and EN982 must be taken into account
Protection degree to DIN EN60529	IP65 with mating connectors
Duty factor	Continuous rating (ED=100%)

**7 SEALS AND HYDRAULIC FLUIDS** - for other fluids not included in below table, consult our technical office

Seals, recommended fluid temperature	NBR seals (standard) = -20°C ÷ +80°C, with HFC hydraulic fluids = -20°C ÷ +50°C FKM seals (/PE option) = -20°C ÷ +80°C HNBR seals (/BT option) = -40°C ÷ +60°C, with HFC hydraulic fluids = -20°C ÷ +50°C		
Recommended viscosity	20 ÷ 100 mm <sup>2</sup> /s - max allowed range 15 ÷ 380 mm <sup>2</sup> /s		
Max fluid contamination level	normal operation	ISO4406 class 18/16/13 NAS1638 class 7	see also filter section at
	longer life	ISO4406 class 16/14/11 NAS1638 class 5	www.atos.com or KTF catalog
<b>Hydraulic fluid</b>	<b>Suitable seals type</b>	<b>Classification</b>	<b>Ref. Standard</b>
Mineral oils	NBR, FKM, NBR low temp.	HL, HLP, HLPD, HVLP, HVLPD	DIN 51524
Flame resistant without water	FKM	HFDU, HFDR	ISO 12922
Flame resistant with water	NBR, NBR low temp.	HFC	

8.1 Regulation diagrams (values measure at Δp 10 bar P-T)

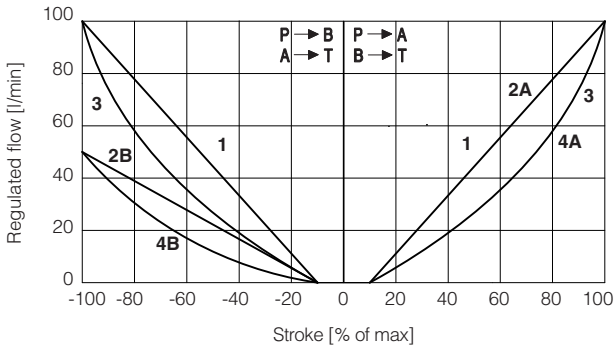

**DPZO-1:**  
 1 = L5    2A = DL5 (P → A, A → T)  
 3 = S5    2B = DL5 (P → B, B → T)  
 4A = D5 (P → A, A → T)  
 4B = D5 (P → B, B → T)

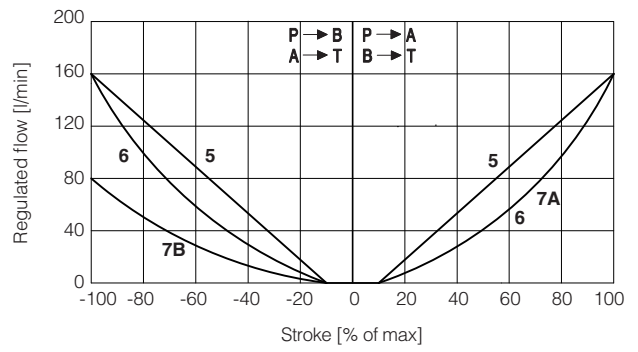

**DPZO-2:**  
 5 = L3    7A = D3 (P → A, A → T)  
 6 = S3    7B = D3 (P → B, B → T)

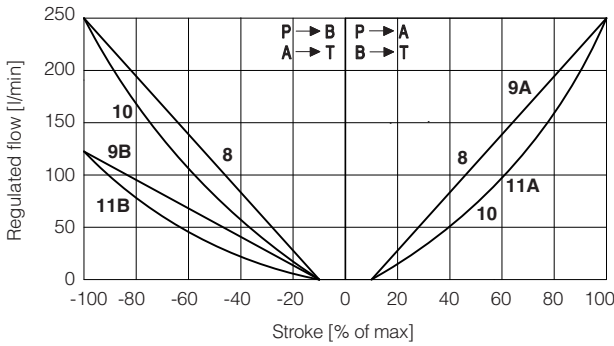

**DPZO-3:**  
 8 = L5    9A = DL5 (P → A, A → T)  
 10 = S5    9B = DL5 (P → B, B → T)  
 11A = D5 (P → A, A → T)  
 11B = D5 (P → B, B → T)

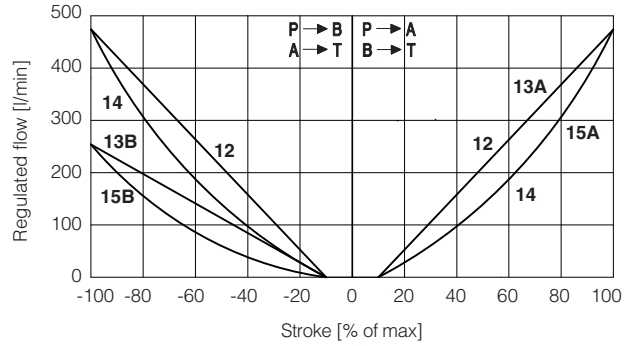

**DPZO-4:**  
 12 = L5    13A = DL5 (P → A, A → T)  
 14 = S5    13B = DL5 (P → B, B → T)  
 15A = D5 (P → A, A → T)  
 15B = D5 (P → B, B → T)

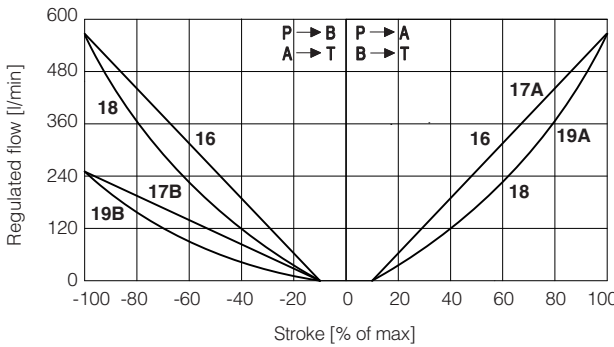

**DPZO-5:**  
 16 = L5    17A = DL5 (P → A, A → T)  
 18 = S5    17B = DL5 (P → B, B → T)  
 19A = D5 (P → A, A → T)  
 19B = D5 (P → B, B → T)

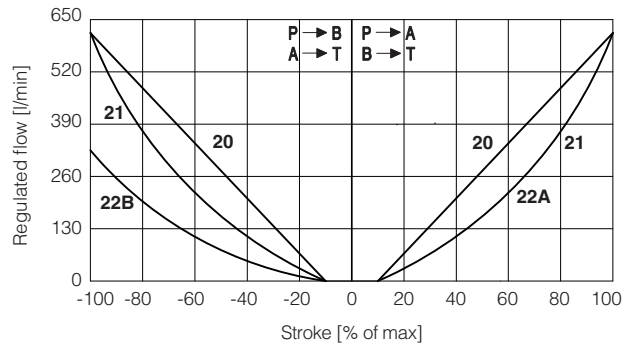

**DPZO-6:**  
 20 = L5    22A = D5 (P → A, A → T)  
 21 = S5    22B = D5 (P → B, B → T)

**Note:**  
 Hydraulic configuration vs. reference signal (standard and option /B)

Reference signal  $\left. \begin{matrix} 0 \div +10 \text{ V} \\ 12 \div 20 \text{ mA} \end{matrix} \right\} P \rightarrow A / B \rightarrow T$

Reference signal  $\left. \begin{matrix} 0 \div -10 \text{ V} \\ 12 \div 4 \text{ mA} \end{matrix} \right\} P \rightarrow B / A \rightarrow T$

**23** = differential - regenerative spool **D9**  
(not available for valve size 32 and 35)

D9 spool type with a fourth position specific to regenerative circuit, performed by means of an additional external check valve.

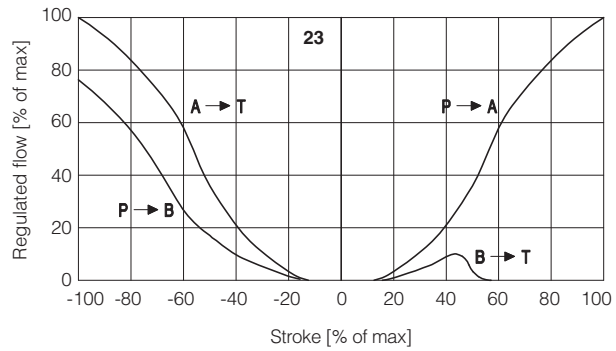
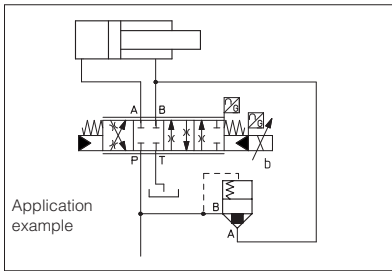

**24** = linear - internal regenerative spool **L9**  
(available only for valve size 16)

L9 spool type with a fourth position specific to perform a regenerative circuit internal to the valve.

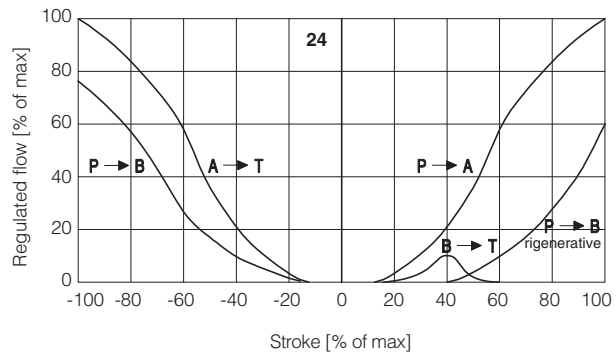

**25** = linear spool **Q5**  
(not available for valve size 32 and 35)

Q5 spool type is specific for alternate P/Q controls in combination with /S\* option of digital integral drivers, (see tech. table **FS500**). It allows to control the pressure in A port or B port and it provides a safety central position (A-T/B-T) to depressurize the actuator chambers. The strong meter-in characteristic makes the spool suitable for both pressure control and motion regulations in several applications.

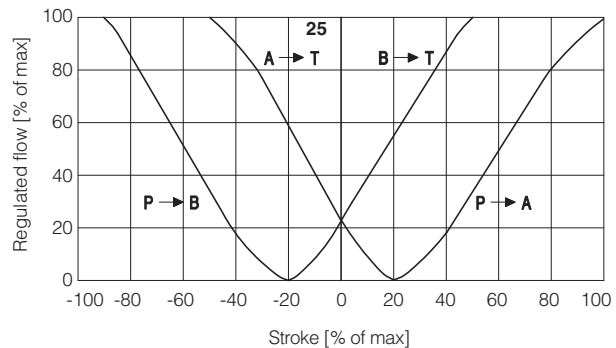

**26** = differential - progressive spool **V9**

V9 spool type is specific for alternate P/Q controls in combination with S\* option of digital integral drivers (see tech table **FS500**).

This spool is specially designed to manage the whole injection cycle in plastic machinery, thanks to the following specific features:

- strong meter-in characteristic to allow the pressure control in A port during the holding pressure (P-A) and the plasticizing (A-T) phases
- safety central position (A-T/B-T) to depressurize the actuator chambers
- large A-T and B-T flow capability, required during the plasticizing phase, to discharge big volumes from high differential injection cylinders with low pressure drops and permitting the contemporary oil suction from tank

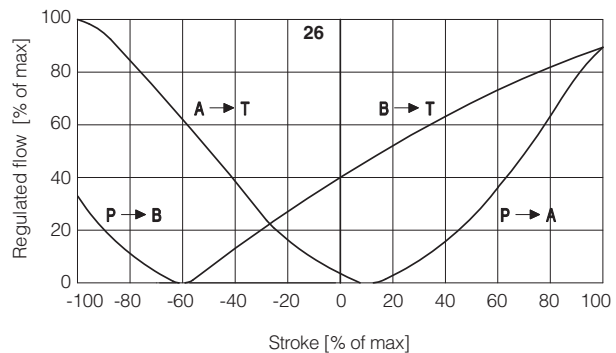

## 8.2 Operating diagrams

### Flow / $\Delta p$ diagram

stated at 100% of spool stroke

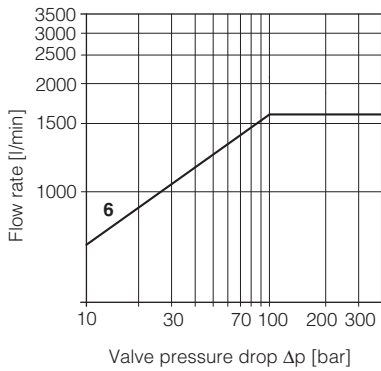
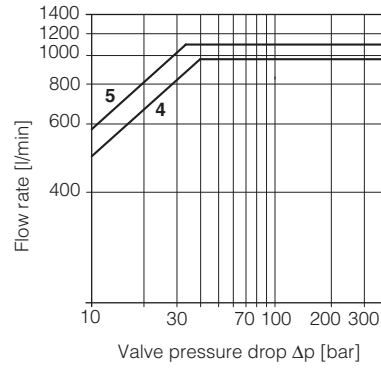
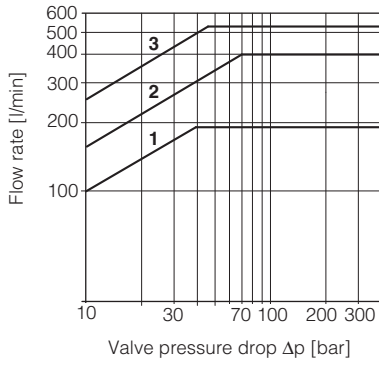

#### DPZO-1:

1 = spools L5, S5, D5, DL5, D9, V9, Q5

#### DPZO-2:

2 = spools L3, S3, D3

3 = spools L5, S5, D5, DL5, D9, L9, V9, Q5

#### DPZO-4:

4 = spools L5, S5, D5, DL5, D9, V9, Q5

#### DPZO-4M:

5 = spools L5, S5, D5, DL5, D9, V9, Q5

#### DPZO-6:

6 = L5, S5, D5, V9

## 8.3 Response time

The response times in below diagrams are measured at different steps of the reference input signal. They have to be considered as average values. For the valves with digital electronics the dynamics performances can be optimized by setting the internal software parameters.

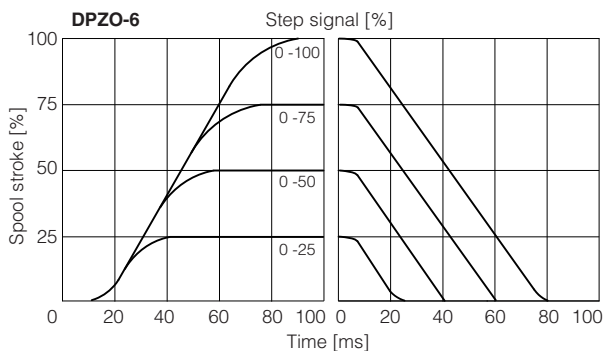
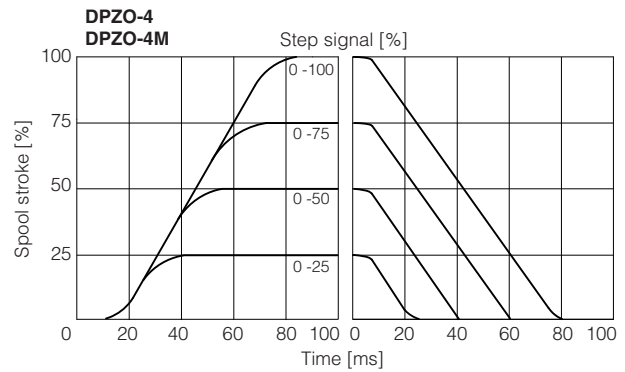
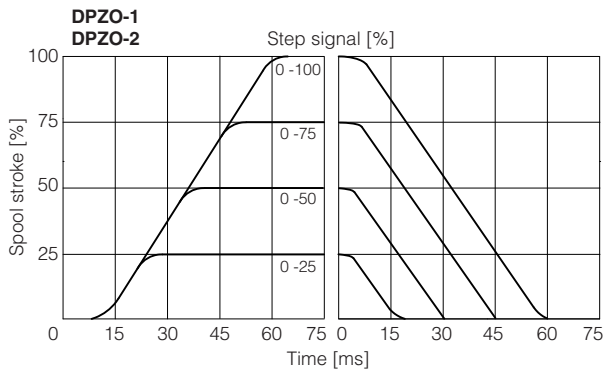

**9 HYDRAULIC OPTIONS**

- B** = Solenoid and LVDT transducer at side of port B of the main stage (side A of pilot valve). For hydraulic configuration vs reference signal, see 8. 1
- D** = Internal drain (through port T).  
Pilot and drain configuration can be modified as shown in the functional scheme here aside. For detailed view of plugs position, see section 12  
The valve's standard configuration provides internal pilot and external drain.
- E** = External pilot (through port X).  
Pilot and drain configuration can be modified as shown in the functional scheme here aside. For detailed view of plugs position, see section 12  
The valve's standard configuration provides internal pilot and external drain.
- G** = Pressure reducing valve ③ with fixed setting, installed between pilot valve and main body. Reduced pressure setting:  
DPZO-1, DPZO-2, DPZO-4(M) and DPZO-6 = **40 bar**  
It is advisable for valves with internal pilot in case of system pressure higher than 150 bar.  
Pressure reducing valve ③ is standard for DPZO-1, for other sizes add /G option.

**Functional Scheme** - example of configuration 71

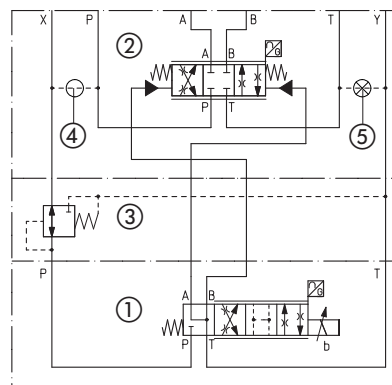

- ① Pilot valve
- ② Main stage
- ③ Pressure reducing valve
- ④ Plug to be added for external pilot trough port X
- ⑤ Plug to be removed for internal drain through port T

**10 ELECTRICAL CONNECTION** - connectors supplied with the valve

**10.1 Pilot valve solenoid connector**

PIN	SIGNAL	TECHNICAL SPECIFICATION	Connector code 666
1	COIL	Power supply	
2	COIL	Power supply	
3	GND	Ground	

**10.2 LVDT pilot transducer connector**

PIN	SIGNAL	TECHNICAL SPECIFICATION	Connector code 345
1	TR	Output signal	
2	VT-	Power supply -15Vdc	
3	VT+	Power supply +15Vdc	
4	GND	Ground	

**10.3 LVDT main stage transducer connector**

PIN	SIGNAL	TECHNICAL SPECIFICATION	Connector code ZBE-08
1	PROG	Do not connect	
2	VT+	Power supply +15Vdc	
3	AGND	Ground	
4	TR	Output signal	
5	VT-	Power supply -15Vdc	

**11 FASTENING BOLTS AND SEALS**

Type	Size	Fastening bolts	Seals
<b>DPZO</b>	<b>1</b> = 10	4 socket head screws M6x40 class 12.9 Tightening torque = 15 Nm	5 OR 2050; Diameter of ports A, B, P, T: Ø 11 mm (max) 2 OR 108 Diameter of ports X, Y: Ø = 5 mm (max)
	<b>2</b> = 16	4 socket head screws M10x50 class 12.9 Tightening torque = 70 Nm 2 socket head screws M6x45 class 12.9 Tightening torque = 15 Nm	4 OR 130; Diameter of ports A, B, P, T: Ø 20 mm (max) 2 OR 2043 Diameter of ports X, Y: Ø = 7 mm (max)
	<b>4</b> = 25	6 socket head screws M12x60 class 12.9 Tightening torque = 125 Nm	4 OR 4112; Diameter of ports A, B, P, T: Ø 24 mm (max) 2 OR 3056 Diameter of ports X, Y: Ø = 7 mm (max)
	<b>4M</b> = 27	6 socket head screws M12x60 class 12.9 Tightening torque = 125 Nm	4 OR 3137; Diameter of ports A, B, P, T: Ø 32 mm (max) 2 OR 3056 Diameter of ports X, Y: Ø = 7 mm (max)
	<b>6</b> = 32	6 socket head screws M20x80 class 12.9 Tightening torque = 600 Nm	4 OR 144; Diameter of ports A, B, P, T: Ø 34 mm (max) 2 OR 3056 Diameter of ports X, Y: Ø = 7 mm (max)

## 12 PLUGS LOCATION FOR PILOT/DRAIN CHANNELS

Depending on the position of internal plugs, different pilot/drain configurations can be obtained as shown below. To modify the pilot/drain configuration, proper plugs must only be interchanged. The plugs have to be sealed using loctite 270. Standard valves configuration provides internal pilot and external drain.

DPZO-1 Pilot channels

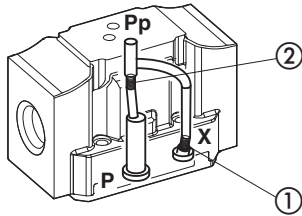

Drain channels

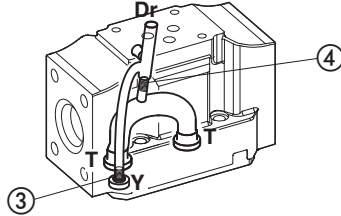

**Internal piloting:** blinded plug SP-X300F ① in X;  
**External piloting:** blinded plug SP-X300F ② in Pp;  
**Internal drain:** blinded plug SP-X300F ③ in Y;  
**External drain:** blinded plug SP-X300F ④ in Dr.

DPZO-2 Pilot channels

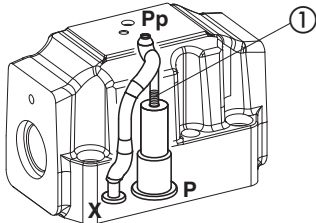

Drain channels

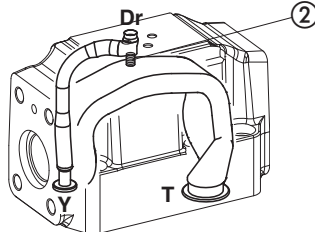

**Internal piloting:** Without blinded plug SP-X300F ①;  
**External piloting:** Add blinded plug SP-X300F ①;  
**Internal drain:** Without blinded plug SP-X300F ②;  
**External drain:** Add blinded plug SP-X300F ②.

DPZO-4 Pilot channels

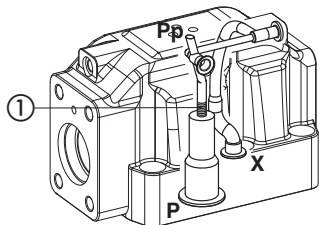

Drain channels

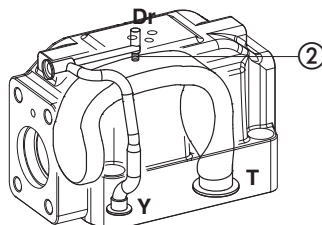

**Internal piloting:** Without blinded plug SP-X500F ①;  
**External piloting:** Add blinded plug SP-X500F ①;  
**Internal drain:** Without blinded plug SP-X300F ②;  
**External drain:** Add blinded plug SP-X300F ②.

DPZO-6 Pilot channels

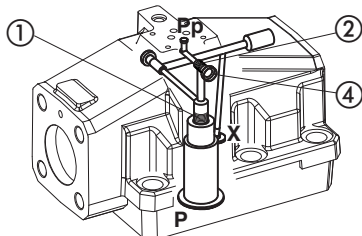

Drain channels

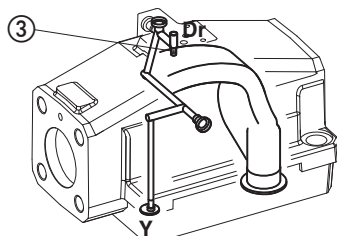

**Internal piloting:** Without plug ①;  
**External piloting:** Add DIN-908 M16x1,5 in pos ①;  
**Internal drain:** Without blinded plug SP-X300F ③;  
**External drain:** Add blinded plug SP-X300F ③.



13 INSTALLATION DIMENSIONS [mm]

**DPZO-L-1**

ISO 4401: 2005

Mounting surface: 4401-05-05-0-05 (see table P005)

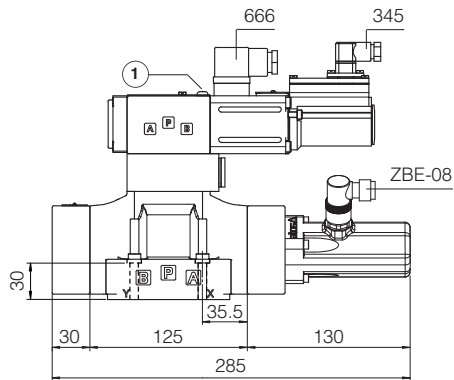

Mass [kg]	
DPZO-L-1	9

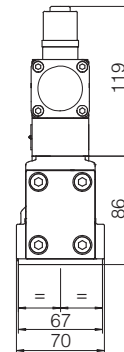

① = Air bleeding 3

**DPZO-L-2**

ISO 4401: 2005

Mounting surface: 4401-07-07-0-05 (see table P005)

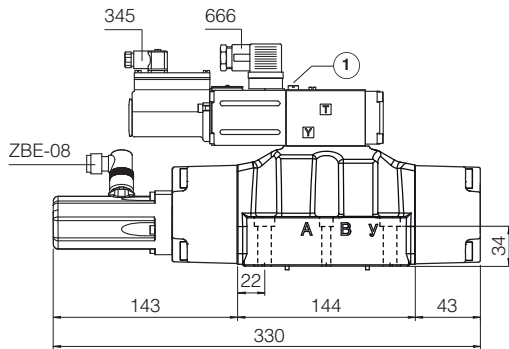

Mass [kg]	
DPZO-L-2	13,5

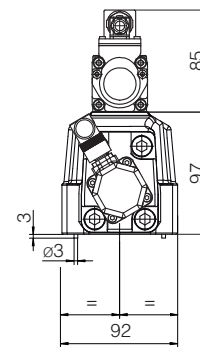

① = Air bleeding 3

**Notes:** the overall height is increased by 30 mm for /G option (0,9 kg);  
for option /B the proportional solenoid and the LVDT transducer are at side of port B of the main stage

## DPZO-L-4

ISO 4401: 2005

Mounting surface: 4401-08-08-0-05 (see table P005)

Mass [kg]	
DPZO-L-4	17,5

## DPZO-L-4M

ISO 4401: 2005

Mounting surface: 4401-08-08-0-05 (see table P005)  
ports A, B, P, T Ø 32mm

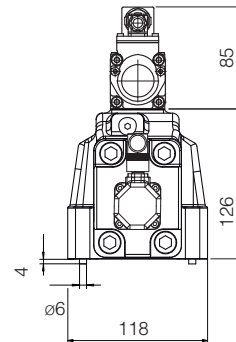
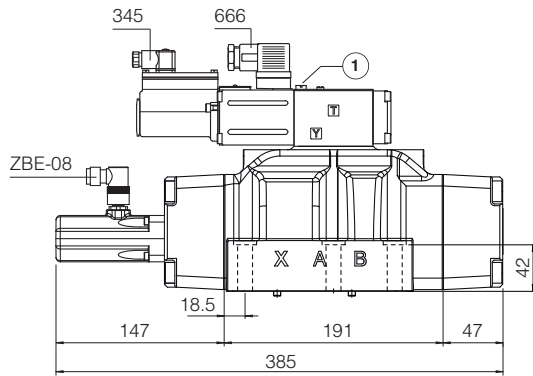

① = Air bleeding 

## DPZO-L-6

ISO 4401: 2005

Mounting surface: 4401-10-09-0-05 (see table P005)

Mass [kg]	
DPZO-L-6	42,5

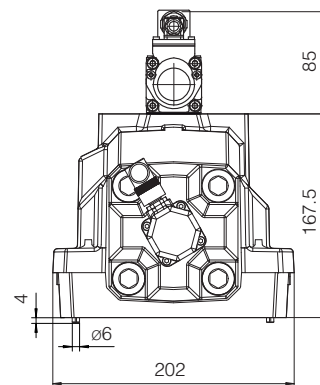
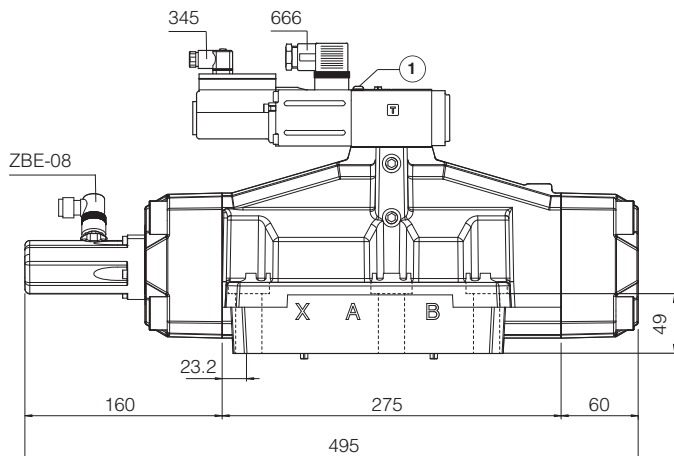

① = Air bleeding 

**Notes:** the overall height is increased by 40 mm for /G option (0,9 kg);  
for option /B the proportional solenoid and the LVDT transducer are at side of port B of the main stage

### 14 RELATED DOCUMENTATION

<b>FS001</b>	Basics for digital electrohydraulics	<b>GS500</b>	Programming tools
<b>FS900</b>	Operating and maintenance information for proportional valves	<b>GS510</b>	Fieldbus
<b>GS230</b>	E-BM-LEB digital driver	<b>K800</b>	Electric and electronic connectors
<b>GS240</b>	E-BM-LES digital driver	<b>P005</b>	Mounting surfaces for electrohydraulic valves