

Ex-proof servoproportional directional valves

piloted, with two LVDT transducers and zero spool overlap - **ATEX, IECEX, EAC, CCC**

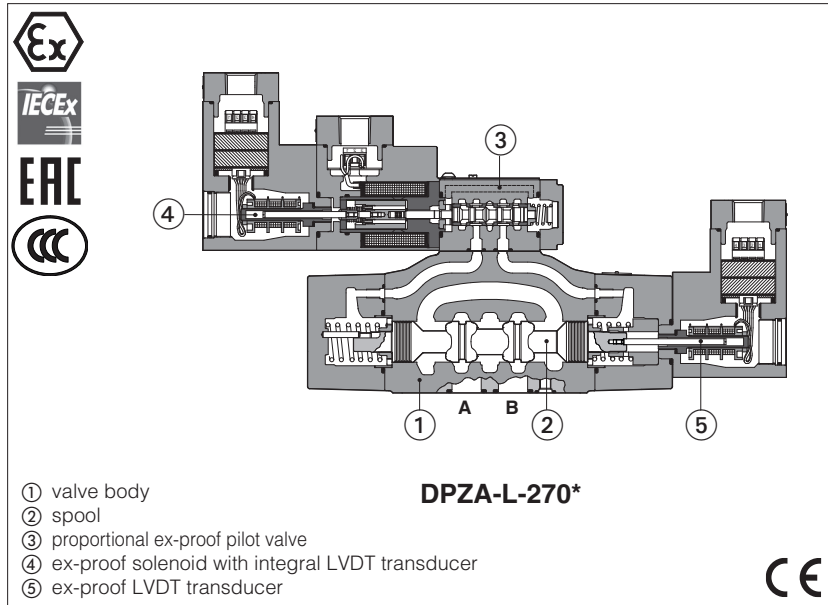

DPZA-L

Ex-proof servoproportional directional valves, piloted with two LVDT position transducers (pilot valve and main stage) and zero spool overlap for position closed loop controls.

They are equipped with ex-proof LVDT transducer and proportional solenoid certified for safe operations in hazardous environments with potentially explosive atmosphere.

- Multicertification **ATEX, IECEX, EAC** and **CCC** for gas group **II 2G** and dust category **II 2D**
- Multicertification **ATEX** and **IECEX** for gas group **I M2** (mining)





The flameproof enclosure of solenoid and transducers, prevents the propagation of accidental internal sparks or fire to the external environment. The driver and solenoid are also designed to limit the surface temperature within the classified limits.

Size: **10 ÷ 27** -ISO4401

Max flow: **180 ÷ 800 l/min**

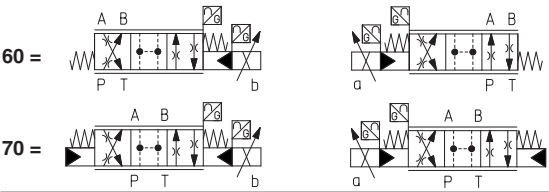
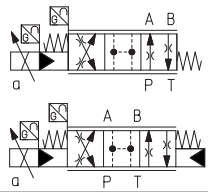
Max pressure: **350 bar**

1 MODEL CODE

DPZA	/	*	-	L	-	2	70	-	L		5	/	M	/	*	/	*	/	*																				
<p>Ex-proof proportional directional valve, piloted</p> <p>Certification type: Multicertification ATEX, IECEX, EAC, CCC: - = omit for Group II 2G / 2D M = Group I (mining)</p> <p>L = with two LVDT transducers</p> <p>Valve size ISO 4401: 1 = 10 2 = 16 4 = 25 4M = 27</p> <p>Configuration: Standard</p>  <p>Option /B</p>  <p>Spool type, regulating characteristics:</p> <p>L =  linear T =  non linear (1)</p> <p>DL =  differential-linear P-A = Q, B-T = Q/2 P-B = Q/2, A-T = Q</p>										<p>Series number</p> <p>Seals material, see section [6]: - = NBR PE = FKM BT = HNBR</p> <p>Hydraulic options (2): B = main stage position transducer at side of port A (3) C = current feedback for position transducer 4÷20 mA D = internal drain E = external pilot pressure G = pressure reducing valve for piloting (standard for size 10)</p> <p>Solenoid and transducers threaded connection for cable gland fitting: GK = GK-1/2" M = M20x1,5 NPT = 1/2" NPT</p>																													
<p>Spool size</p> <table border="1"> <thead> <tr> <th></th> <th>3 (L)</th> <th>5 (L,DL)</th> <th>5 (T)</th> </tr> </thead> <tbody> <tr> <td>DPZA-1 =</td> <td>-</td> <td>100</td> <td>-</td> </tr> <tr> <td>DPZA-2 =</td> <td>130</td> <td>200</td> <td>150</td> </tr> <tr> <td>DPZA-4 =</td> <td>-</td> <td>340</td> <td>-</td> </tr> <tr> <td>DPZA-4M =</td> <td>-</td> <td>390</td> <td>-</td> </tr> </tbody> </table> <p>Nominal flow (l/min) at Δp 10bar P-T</p>											3 (L)	5 (L,DL)	5 (T)	DPZA-1 =	-	100	-	DPZA-2 =	130	200	150	DPZA-4 =	-	340	-	DPZA-4M =	-	390	-										
	3 (L)	5 (L,DL)	5 (T)																																				
DPZA-1 =	-	100	-																																				
DPZA-2 =	130	200	150																																				
DPZA-4 =	-	340	-																																				
DPZA-4M =	-	390	-																																				

(1) Only for configuration 70

(2) Possible combined options: all combinations are possible

(3) In standard configuration the main stage LVDT transducer is at side of port B, and the pilot solenoid with position transducer are at side A of main stage

2 OFF-BOARD ELECTRONIC DRIVERS

Electronic drivers are factory set with max current limitation for ex-proof valves.
Please include in the driver order also the complete code of the connected ex-proof proportional valve.

Drivers model	E-BM-LEB-* /A	E-BM-LES-* /A
Type	digital	digital
Format	DIN-rail panel	
Data sheet	GS230	GS240

3 GENERAL CHARACTERISTICS

Assembly position	Any position
Subplate surface finishing to ISO 4401	Acceptable roughness index, Ra ≤0,8 recommended Ra 0,4 - flatness ratio 0,01/100
MTTFd valves according to EN ISO 13849	75 years, see technical table P007
Ambient temperature range	Standard = -20°C ÷ +60°C /PE option = -20°C ÷ +60°C /BT option = -40°C ÷ +60°C
Storage temperature range	Standard = -20°C ÷ +70°C /PE option = -20°C ÷ +70°C /BT option = -40°C ÷ +70°C
Surface protection	Zinc coating with black passivation - salt spray test (EN ISO 9227) > 200 h
Compliance	Explosion proof protection, see section [7] -Flame proof enclosure "Ex d" -Dust ignition protection by enclosure "Ex t" RoHs Directive 2011/65/EU as last update by 2015/863/EU REACH Regulation (EC) n°1907/2006

4 HYDRAULIC CHARACTERISTICS - based on mineral oil ISO VG 46 at 50 °C

Valve model	DPZA-*-1	DPZA-*-2			DPZA-*-4	DPZA-*-4M
Pressure limits [bar]	ports P, A, B, X = 350; T = 250 (10 for option /D); Y = 10;					
Spool type	L5, DL5	L3	L5, DL5	T5	L5, DL5	
Nominal flow [l/min] $\Delta p = 10$ bar	100	130	200	150	340	390
Δp P-T $\Delta p = 30$ bar	160	220	350	260	590	670
Max permissible flow	180	320	440	360	680	800
Δp max P-T [bar]	50	60	60	60	60	60
Piloting pressure [bar]	min. = 25; max = 350 (option /G advisable for pilot pressure > 200 bar)					
Piloting volume [cm ³]	1,4		3,7		9,0	11,3
Piloting flow (1) [l/min]	1,7		3,7		6,8	8
Leakage Pilot [cm ³ /min]	100/300		150/450		200/600	200/600
(2) Main stage [l/min]	0,4/1,2		0,6/2,5		1,0/4,0	1,0/4,0
Response time (1) [ms]	≤ 30		≤ 30		≤ 35	≤ 40
Hysteresis	≤ 0,1 [% of max regulation]					
Repeatability	± 0,1 [% of max regulation]					
Thermal drift	zero point displacement < 1% at $\Delta T = 40^\circ C$					

(1) 0 ÷ 100 % step signal and pilot pressure 100 bar

(2) at P = 100/350 bar

5 ELECTRICAL CHARACTERISTICS

Max. power	35W
Insulation class	H (180°) Due to the occurring surface temperatures of the solenoid coils, the European standards ISO 13732-1 and EN982 must be taken into account
Protection degree	IP66/67 to DIN EN60529 with relevant cable gland
Duty factor	Continuous rating (ED=100%)
Voltage code	standard
Coil resistance R at 20°C	3,2 W
Max. solenoid current	2,5 A

6 SEALS AND HYDRAULIC FLUIDS - for other fluids not included in below table, consult our technical office

Seals, recommended fluid temperature	NBR seals (standard) = -20°C ÷ +60°C, with HFC hydraulic fluids = -20°C ÷ +50°C FKM seals (/PE option) = -20°C ÷ +80°C HNBR seals (/BT option) = -40°C ÷ +60°C, with HFC hydraulic fluids = -40°C ÷ +50°C		
Recommended viscosity	20 ÷ 100 mm ² /s - max allowed range 15 ÷ 380 mm ² /s		
Max fluid contamination level	normal operation ISO4406 class 18/16/13 NAS1638 class 7	see also filter section at www.atos.com or KTF catalog	
longer life	ISO4406 class 16/14/11 NAS1638 class 5		
Hydraulic fluid	Suitable seals type	Classification	Ref. Standard
Mineral oils	NBR, FKM, HNBR	HL, HLP, HLPD, HVLP, HVLPD	DIN 51524
Flame resistant without water	FKM	HFDU, HFDR	ISO 12922
Flame resistant with water (1)	NBR, HNBR	HFC	

⚠ The ignition temperature of the hydraulic fluid must be 50°C higher than the max solenoid surface temperature

(1) Performance limitations in case of flame resistant fluids with water:

-max operating pressure = 210 bar -max fluid temperature = 50°C



The loss of the pilot pressure causes the undefined position of the main poppet.

The sudden interruption of the power supply during the valve operation causes the immediate shut-off of the main poppet.

This could cause pressure surges in the hydraulic system or high decelerations which may lead to machine damages.

7 CERTIFICATION DATA

Valve type	DPZA		DPZA/M
Certifications	Multicertification Group II ATEX IECEx EAC CCC		Multicertification Group I ATEX IECEx
Solenoid and LVDT transducer certified code (pilot stage)	OZA-T		OZAM-T
Type examination certificate (1)	ATEX: CESI 02 ATEX 014 IECEX: IECEX CES 10.0010x EAC:RU C - IT.AX38.B.00425/21 CCC:2020322307003240		ATEX: CESI 03 ATEX 057x IECEX: IECEX CES 12.0007x
Method of protection	<ul style="list-style-type: none"> • ATEX: Ex II 2G Ex db IIC T4/T3 Gb Ex II 2D Ex tb IIIC T135°C/T200°C Db • IECEX: Ex db IIC T4/T3 Gb Ex tb IIIC T135°C/T200°C Db • EAC: 1Ex d IIC T4/T3 Gb X Ex tb IIIC T135°C/T200°C Db X • CCC : Ex d IIC T4/T3 Gb Ex tD A21 IP66/IP67 T135°C/T200°C 		<ul style="list-style-type: none"> • ATEX: Ex I M2 Ex db I Mb • IECEX: Ex db I Mb
LVDT transducer certified code (main stage)	ETHA-4/*		ETHAM-4/*
Type examination certificate (1)	ATEX: CESI 02 ATEX 015X / 06 IECEX: IECEX CES 12.006X EAC:RU C - IT.AX38.B.00425/21 CCC:2021322315003690		ATEX: CESI 03 ATEX 057x IECEX: IECEX CES 12.0007x
Method of protection	<ul style="list-style-type: none"> • ATEX: Ex II 2G Ex db IIC T6/T5/T4 Gb Ex II 2D Ex tb IIIC T85°C/T100°C/135°C Db • IECEX: Ex db IIC T6/T5/T4 Gb Ex tb IIIC T85°C/T100°C/135°C Db • EAC: 1Ex d IIC T4/T3 Gb X Ex tb IIIC T135°C/T200°C Db X • CCC: Ex d IIC T6/T5/T4 Gb Ex tD A21 IP66/IP67 T85°C/T135°C/T200°C 		<ul style="list-style-type: none"> • ATEX: Ex I M2 Ex db I Mb • IECEX: Ex db I Mb
Temperature class	T4	T3	-
Surface temperature	≤ 135 °C	≤ 200 °C	≤ 150 °C
Ambient temperature (2)	-40 ÷ +40 °C	-40 ÷ +70 °C	-20 ÷ +60 °C
Applicable standards	EN 60079-0; EN 60079-1; EN 60079-31		IEC 60079-0; IEC 60079-1; IEC 60079-31
Cable entrance: threaded connection	GK = GK-1/2" M = M20x1,5 NPT = 1/2" NPT		

(1) The type examination certificates can be downloaded from www.atos.com

(2) In case the complete valve must withstand with minimum ambient temperature of -40°C, select **/BT** in the model code

⚠ WARNING: service work performed on the valve by the end users or not qualified personnel invalidates the certification

8 EX PROOF SOLENOIDS AND LVDT TRANSDUCER WIRING

Pilot valve solenoid and LVDT transducer

n°8 M4x20
locking torque 4Nm

- ① solenoid cover with threaded connection for cable gland fitting
- ② transducer cover with threaded connection for cable gland fitting
- ③ solenoid terminal board for cables wiring
- ④ transducer terminal board for cables wiring
- ⑤ screw terminal for additional equipotential grounding

Solenoid wiring

	1 = Coil	PCB 3 poles terminal board suitable for wires cross sections up to 2,5 mm ² (max AWG14)
	2 = GND	
	3 = Coil	

LVDT main stage transducer

n°4 M4
locking torque 4Nm

- ① cover with threaded connection for vertical cable gland fitting
- ② terminal board for cables wiring
- ③ screw terminal for additional equipotential grounding

Position transducer wiring

	1 = Output signal	PCB 4 poles terminal board suitable for wires cross sections up to 2,5 mm ² (max AWG14)
	2 = Supply -15 V	
	3 = Supply +15 V	
	4 = GND	

9 CABLE SPECIFICATION AND TEMPERATURE - Power supply and grounding cables have to comply with following characteristics:

Multicertification Group I and Group II

Power supply: section of coil connection wires = 2,5 mm²

Grounding: section of internal ground wire = 2,5 mm²
section of external ground wire = 4 mm²

9.1 Cable temperature

The cable must be suitable for the working temperature as specified in the "safety instructions" delivered with the first supply of the products.

SOLENOID - Multicertification

Max ambient temperature [°C]	Temperature class		Max surface temperature [°C]		Min. cable temperature [°C]	
	Goup I	Goup II	Goup I	Goup II	Goup I	Goup II
40 °C	-	T4	150 °C	135 °C	90 °C	90 °C
45 °C	-	T4	-	135 °C	-	95 °C
55 °C	-	T3	-	200 °C	-	110 °C
60 °C	-	-	150 °C	-	110 °C	-
70 °C	N.A.	T3	N.A.	200 °C	N.A.	120 °C

TRANSDUCER - Multicertification

Max ambient temperature [°C]	Temperature class		Max surface temperature [°C]		Min. cable temperature [°C]	
	Goup I	Goup II	Goup I	Goup II	Goup I	Goup II
40 °C	N.A.	T6	150 °C	85 °C	-	-
70 °C	N.A.	T6	150 °C	85 °C	90 °C	90 °C

10 CABLE GLANDS

Cable glands with threaded connections GK-1/2", 1/2"NPT or M20x1,5 for standard or armoured cables have to be ordered separately, see tech. table **KX800**

Note: a Loctite sealant type 545, should be used on the cable gland entry threads

11 HYDRAULIC OPTIONS

- B** = Solenoid and position transducer at side of port B of the main stage.
- C** = Option /C is available to connect pressure (force) transducers with 4 ÷ 20 mA current output signal, instead of the standard ±10 VDC. Input signal can be reconfigured via software selecting between voltage and current, within a maximum range of ±10 VDC or ±20 mA.
- D and E** = Pilot and drain configuration can be modified as shown in section 13. The valve's standard configuration provides internal pilot and external drain. For different pilot / drain configuration select:
 - Option /D Internal drain.
 - Option /E External pilot (through port X).
- G** = Pressure reducing valve installed between pilot valve and main body with fixed setting:
 - DPZA-2 = 28 bar
 - DPZA-1, -4 and -4M = 40 bar
 It is advisable for valves with internal pilot in case of system pressure higher than 150 bar. Pressure reducing valve is standard for DPZA-1, for other sizes add /G option.

FUNCTIONAL SCHEME - example of configuration 70

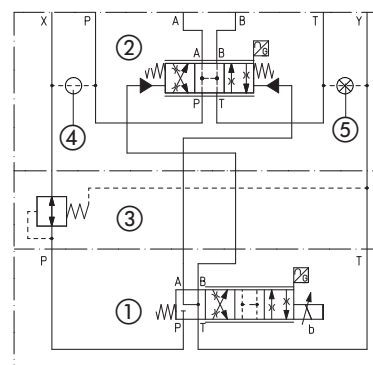

- ① Pilot valve
- ② Main stage
- ③ Pressure reducing valve
- ④ Plug to be added for external pilot trough port X
- ⑤ Plug to be removed for internal drain through port T

12 DIAGRAMS (based on mineral oil ISO VG 46 at 50 °C)

12.1 Regulation diagrams (values measure at Δp 10 bar P-T)

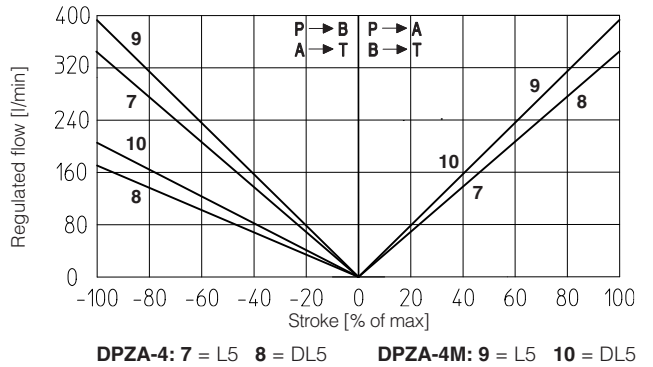
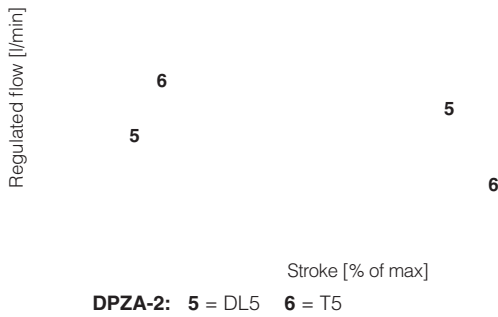
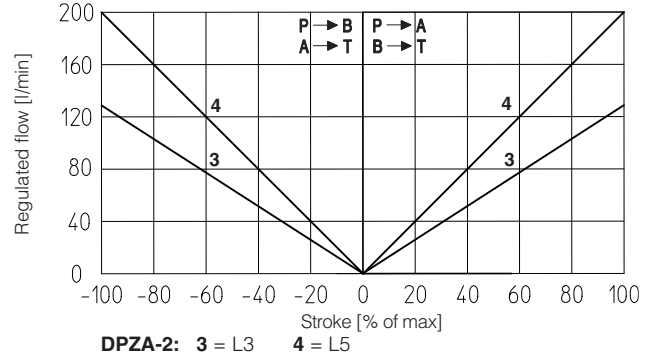
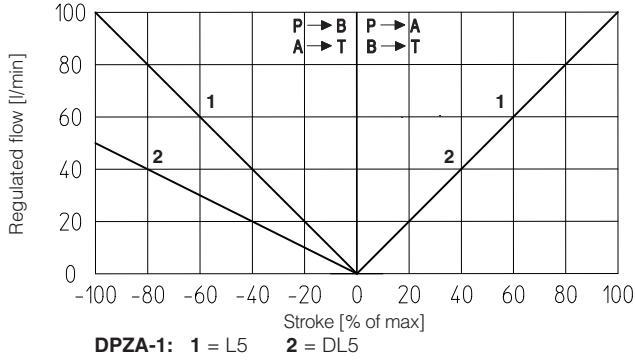

Note: Hydraulic configuration vs. reference signal for configurations 60 and 70 (standard and option /B)

Reference signal $\begin{matrix} 0 \div +10 \text{ V} \\ 12 \div 20 \text{ mA} \end{matrix} \} P \rightarrow A / B \rightarrow T$ Reference signal $\begin{matrix} 0 \div -10 \text{ V} \\ 4 \div 12 \text{ mA} \end{matrix} \} P \rightarrow B / A \rightarrow T$

12.2 Bode diagrams

Stated at nominal hydraulic conditions.

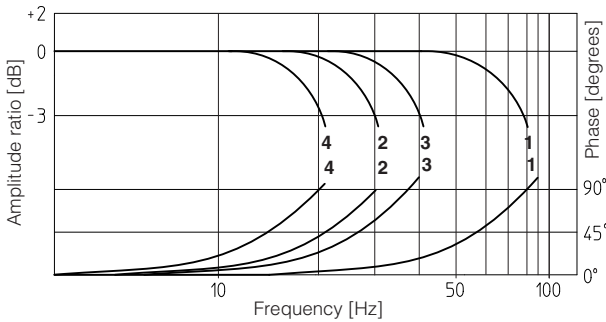

1 = DPZA-1 } ± 5% 2 = DPZA-1 } ± 100%
 DPZA-2 } DPZA-2 }
 3 = DPZA-4 } ± 5% 4 = DPZA-4 } ± 100%
 DPZA-4M } DPZA-4M }

12.3 Pressure gain

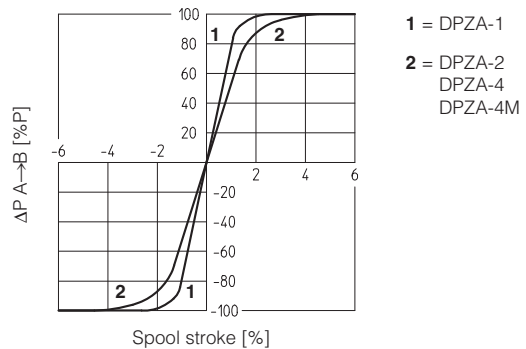
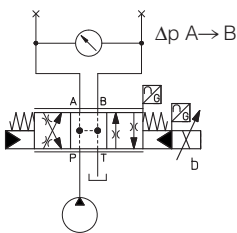

13.4 Safety rest position - configuration 70

In absence of electric power supply (+24 VDC), the valve main spool is moved by the springs force to the **central safety rest position** characterized by a small offset of about 1% to 6% of the total stroke in P-B / A-T configuration.

This is specifically designed to avoid that in case of accidental interruption of the electrical power supply to the valve, the actuator moves towards an undefined direction (due to the tolerances of the zero overlap spool), with potential risk of damages or personnel injury.

Thanks to the **central safety rest position** the actuator movement is suddenly stopped and it is recovered at very low speed towards the direction corresponding to the P-B/ A-T connection.

The main spool moves to the closed loop control position (zero overlap) when the pilot pressure is activated, the valve is fed with power supply +24 VDC and reference input = 0V (or 12 mA for option /I) is applied to the driver.

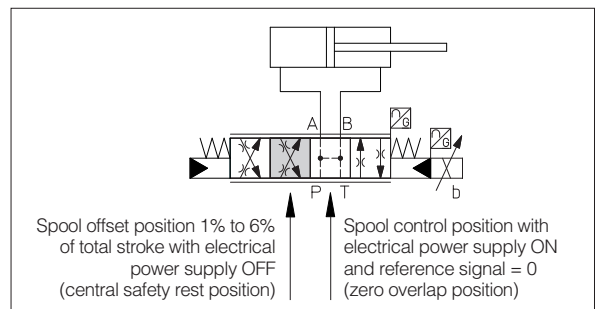

13 PLUGS LOCATION FOR PILOT/DRAIN CHANNELS

Depending on the position of internal plugs, different pilot/drain configurations can be obtained as shown below.
To modify the pilot/drain configuration, proper plugs must only be interchanged. The plugs have to be sealed using loctite 270.
Standard valves configuration provides internal pilot and external drain

DPZA-1	Pilot channels	Drain channels	<p>Internal piloting: blinded plug SP-X300F ① in X; External piloting: blinded plug SP-X300F ② in Pp; Internal drain: blinded plug SP-X300F ③ in Y; External drain: blinded plug SP-X300F ④ in Dr.</p>
DPZA-2	Pilot channels	Drain channels	<p>Internal piloting: Without blinded plug SP-X300F ①; External piloting: Add blinded plug SP-X300F ①; Internal drain: Without blinded plug SP-X300F ②; External drain: Add blinded plug SP-X300F ②.</p>
DPZA-4 DPZA-4M	Pilot channels	Drain channels	<p>Internal piloting: Without blinded plug SP-X500F ①; External piloting: Add blinded plug SP-X500F ①; Internal drain: Without blinded plug SP-X300F ②; External drain: Add blinded plug SP-X300F ②.</p>

14 FASTENING BOLTS AND SEALS

Type	Size	Fastening bolts	Seals
DPZA	1 = 10	4 socket head screws M6x40 class 12.9 Tightening torque = 15 Nm	5 OR 2050; Diameter of ports A, B, P, T: Ø 11 mm (max) 2 OR 108 Diameter of ports X, Y: Ø = 7 mm (max)
	2 = 16	4 socket head screws M10x50 class 12.9 Tightening torque = 70 Nm 2 socket head screws M6x45 class 12.9 Tightening torque = 15 Nm	4 OR 130; Diameter of ports A, B, P, T: Ø 20 mm (max) 2 OR 2043 Diameter of ports X, Y: Ø = 9 mm (max)
	4 = 25	6 socket head screws M12x60 class 12.9 Tightening torque = 125 Nm	4 OR 4112; Diameter of ports A, B, P, T: Ø 25 mm (max) 2 OR 3056 Diameter of ports X, Y: Ø = 11,5 mm (max)
	4M = 27	6 socket head screws M12x60 class 12.9 Tightening torque = 125 Nm	4 OR 3137; Diameter of ports A, B, P, T: Ø 34 mm (max) 2 OR 3056 Diameter of ports X, Y: Ø = 7 mm (max)

DPZA-L-*-1

ISO 4401: 2005
 Mounting surface: 4401-05-05-0-05
 (see table P005)

Mass [kg]	
DPZA-*-17*	9,7

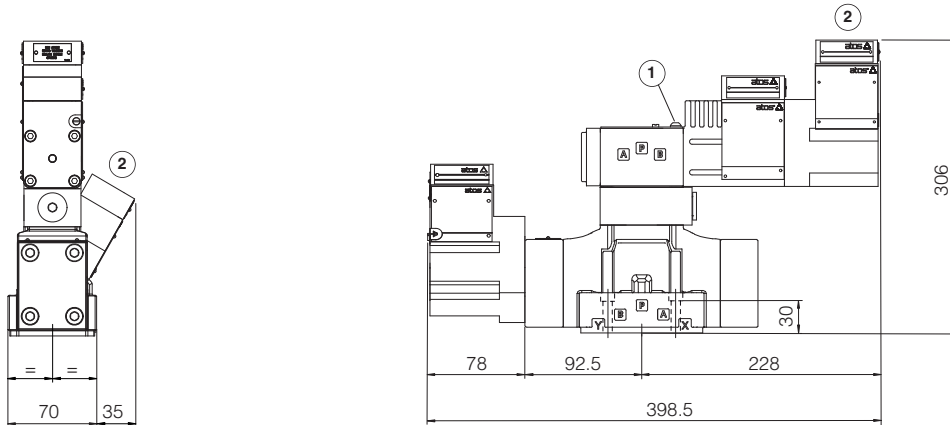

DPZA-L-*-2

ISO 4401: 2005
 Mounting surface: 4401-07-07-0-05
 (see table P005)

Mass [kg]	
DPZA-*-27*	13
Option /G	+0,9

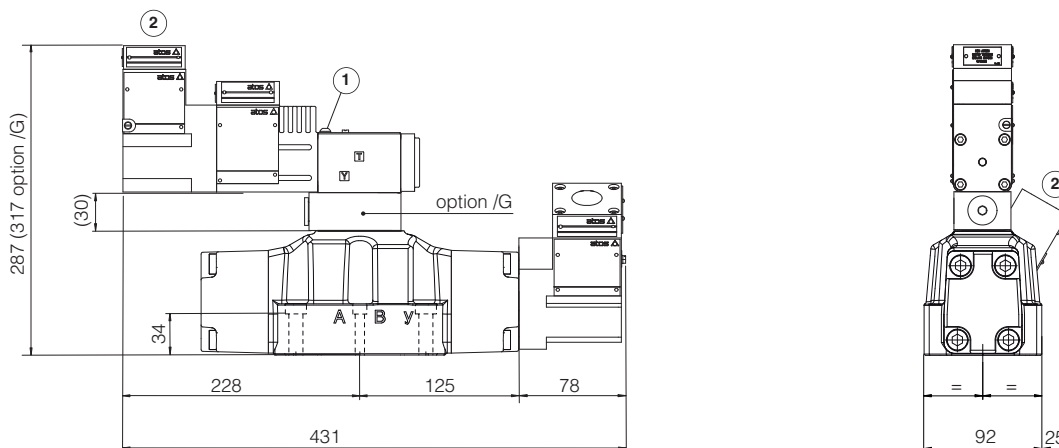

① = Air bleed off

② = The dimensions of cable glands must be considered (see tech table **KX800**)

DPZA-L-* DPZA-L-*4M

ISO 4401: 2005
 Mounting surface: 4401-08-08-0-05
 (see table P005)

Mass [kg]	
DPZA-* ⁴ *	18,2
DPZA-* ⁴ M*	18,2
Option /G	+0,9

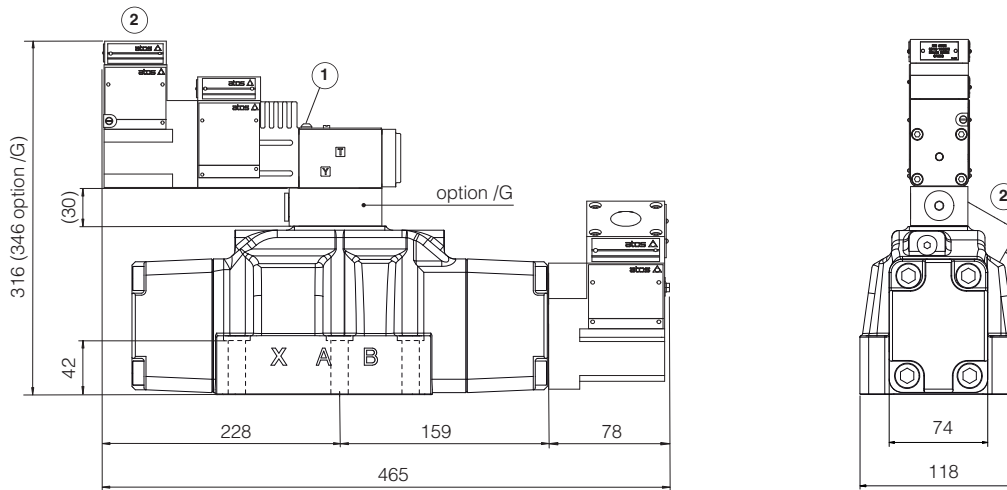

- ① = Air bleed off
- ② = The dimensions of cable glands must be considered (see tech table **KX800**)

16 RELATED DOCUMENTATION

- X010** Basics for electrohydraulics in hazardous environments
- X020** Summary of Atos ex-proof components certified to ATEX, IECEx, EAC, PESO, CCC
- FX900** Operating and maintenance information for ex-proof proportional valves
- KX800** Cable glands for ex-proof valves
- P005** Mounting surfaces for electrohydraulic valves