

Ex-proof servoproportional 3-way cartridges

piloted, with two LVDT transducers - **ATEX, IECEx, EAC, CCC**

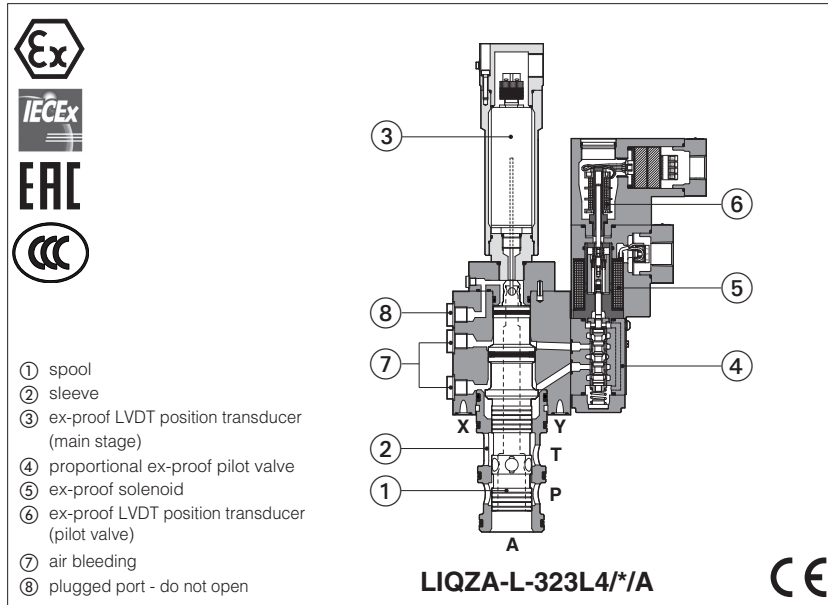

- ① spool
- ② sleeve
- ③ ex-proof LVDT position transducer (main stage)
- ④ proportional ex-proof pilot valve
- ⑤ ex-proof solenoid
- ⑥ ex-proof LVDT position transducer (pilot valve)
- ⑦ air bleeding
- ⑧ plugged port - do not open

LIQZA-L-323L4*/A



LIQZA-L

Ex-proof digital servoproportional 3-way cartridges, with two LVDT position transducers (pilot valve and main stage) for best accuracy in not compensated flow regulations.

They are equipped with ex-proof proportional solenoid and LVDT transducers certified for safe operations in hazardous environments with potentially explosive atmosphere.

- Multicertification **ATEX, IECEx, EAC** and **CCC** for gas group **II 2G** and dust category **II 2D**
- Multicertification **ATEX** and **IECEx** for gas group **I M2** (mining)

The flameproof enclosure of solenoid and transducers prevent the propagation of accidental internal sparks or fire to the external environment.

They are also designed to limit the surface temperature within the classified limits.

Size: **25 ÷ 80** - not ISO cavity

Max flow: **500 ÷ 5000 l/min**

Max pressure: **420 bar**

1 MODEL CODE

LIQZA	/	*	-	L	-	25	3	L4	/	M	/	*	*	/	*	
Ex-proof proportional cartridge													Series number			Seals material, see section 8 : - = NBR PE = FKM BT = NBR low temp.
Certification: Multicertification ATEX, IECEx, EAC, CCC: - = omit for Group II 2G M = Group I (mining) - ATEX, IECEx																
Options: A = reversal hydraulic configuration of main spool: P-A in rest position																
Solenoid and transducer (main stage and pilot valve) threaded connection for cable gland fitting: M = M20x1,5																
Poppet type, regulating characteristics:  L4 = linear																

L = with two LVDT transducers

Valve size and nominal flow (l/min) at Δp 5 bar:

- 25** = 185
- 32** = 330
- 40** = 420
- 50** = 780
- 63** = 1250
- 80** = 2100

Configuration: 3 = 3 way

functional symbol: **Standard**

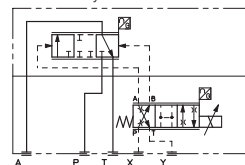

simplified symbol: **Standard**

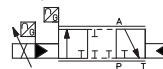

option **/A**

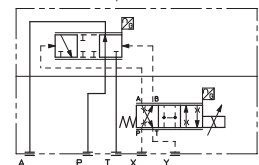

option **/A**

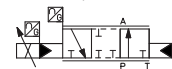

2 ELECTRONIC DRIVERS

Electronic drivers are factory set with max current limitation for ex-proof valves.
Please include in the driver order also the complete code of the connected ex-proof proportional valve.

Drivers model	E-BM-LEB-* /A	E-BM-LES-* /A
Type	digital	digital
Format	DIN-rail panel	
Data sheet	GS230	GS240

3 GENERAL CHARACTERISTICS

Assembly position	Any position
Subplate surface finishing to ISO 4401	Acceptable roughness index, Ra ≤0,8 recommended Ra 0,4 - flatness ratio 0,01/100
MTTFd valves according to EN ISO 13849	75 years, see technical table P007
Ambient temperature range	Standard = -20°C ÷ +60°C /PE option = -20°C ÷ +60°C /BT option = -40°C ÷ +60°C
Storage temperature range	Standard = -20°C ÷ +70°C /PE option = -20°C ÷ +70°C /BT option = -40°C ÷ +70°C
Surface protection	Zinc coating with black passivation - salt spray test (EN ISO 9227) > 200 h
Compliance	Explosion proof protection, see section 9 -Flame proof enclosure "Ex d" -Dust ignition protection by enclosure "Ex t" RoHs Directive 2011/65/EU as last update by 2015/863/EU REACH Regulation (EC) n°1907/2006

4 HYDRAULIC CHARACTERISTICS - based on mineral oil ISO VG 46 at 50 °C

Size	25	32	40	50	63	80
Max regulated flow [l/min]						
at Δp = 5 bar	185	330	420	780	1250	2100
at Δp = 10 bar	260	470	590	1100	1750	3000
Max permissible flow	500	850	1050	2000	3100	5000
Max pressure [bar]	Ports P, A, T = 420 X = 350 Y ≤ 10					
Nominal flow of pilot valve at Δp = 70 bar [l/min]	4	8	28	40	100	100
Leakage of pilot valve at P = 100 bar [l/min]	0,2	0,2	0,5	0,7	0,7	0,7
Piloting pressure [bar]	min: 40% of system pressure max 350 recommended 140 ÷ 160					
Piloting volume [cm³]	2,16	7,2	8,9	17,7	33,8	42,7
Piloting flow (1) [l/min]	6,5	20	25	43	68	76
Response time (2) [ms]	≤ 25	≤ 27	≤ 27	≤ 30	≤ 35	≤ 40
Hysteresis [% of the max regulation]	≤ 0,1					
Repeatability [% of the max regulation]	± 0,1					
Thermal drift	zero point displacement < 1% at ΔT = 40°C					

(1) 0÷100% step signal (2) With pilot pressure = 140 bar

5 ELECTRICAL CHARACTERISTICS

Max. power	35W
Insulation class	H (180°) Due to the occurring surface temperatures of the solenoid coils, the European standards ISO 13732-1 and EN982 must be taken into account
Protection degree	IP66/67 to DIN EN60529 with relevant cable gland raintight enclosure, UL approved
Duty factor	Continuous rating (ED=100%)
Voltage code	standard
Coil resistance R at 20°C	3,2 Ω
Max. solenoid current	2,5 A

6 SEALS AND HYDRAULIC FLUIDS - for other fluids not included in below table, consult our technical office

Seals, recommended fluid temperature	NBR seals (standard) = -20°C ÷ +60°C, with HFC hydraulic fluids = -20°C ÷ +50°C FKM seals (/PE option) = -20°C ÷ +80°C HNBR seals (/BT option) = -40°C ÷ +60°C, with HFC hydraulic fluids = -40°C ÷ +50°C		
Recommended viscosity	20 ÷ 100 mm²/s - max allowed range 15 ÷ 380 mm²/s		
Max fluid contamination level	normal operation longer life	ISO4406 class 18/16/13 NAS1638 class 7 ISO4406 class 16/14/11 NAS1638 class 5	see also filter section at www.atos.com or KTF catalog
Hydraulic fluid	Suitable seals type	Classification	Ref. Standard
Mineral oils	NBR, FKM, HNBR	HL, HLP, HLPD, HVLP, HVLPD	DIN 51524
Flame resistant without water	FKM	HFDD, HFDR	ISO 12922
Flame resistant with water (1)	NBR, NBR low temp.	HFC	

⚠ The ignition temperature of the hydraulic fluid must be 50°C higher than the max solenoid surface temperature

(1) Performance limitations in case of flame resistant fluids with water:

-max operating pressure = 210 bar -max fluid temperature = 50°C



WARNING

The loss of the pilot pressure causes the undefined position of the main poppet.
The sudden interruption of the power supply during the valve operation causes the immediate shut-off of the main poppet.
This could cause pressure surges in the hydraulic system or high decelerations which may lead to machine damages.

7 CERTIFICATION DATA

Valve type	LIQZA		LIQZA/M	LIQZA, LIQZA/M
Component type	Pilot solenoid and LVDT transducer			LVDT main stage transducer
Certifications	Multicertification Group II ATEX IECEx EAC CCC		Multicertification Group I ATEX IECEx	Multicertification Group I and II ATEX IECEx EAC CCC
Solenoid certified code	OZA-T		OZAM-T	ETHA-15
Type examination certificate (1)	ATEX: CESI 02 ATEX 014 IECEX: IECEX CES 10.0010x EAC: RU C-IT. AX38.B.00425/21 CCC:2020322307003240		ATEX: CESI 03 ATEX 057x IECEX: IECEX CES 12.0007x	ATEX: TUV IT 16 ATEX 053X ICEX: IECEX TPS 16.0003X EAC: RU C-IT. AX38.B.00425/21 CCC: 2021322315004329
Method of protection	<ul style="list-style-type: none"> • ATEX Ex II 2G Ex d IIC T4/T3 Gb Ex II 2D Ex tb IIIC T135°C/T200°C Db • IECEx Ex d IIC T4/T3 Gb Ex tb IIIC T85°C/T200°C Db • CCC Ex d IIC T4/T3 Gb Ex tD A21 IP66/IP67 T135°C/T200°C 		<ul style="list-style-type: none"> • ATEX Ex I M2 Ex db I Mb • IECEx Ex db I Mb 	<ul style="list-style-type: none"> • ATEX Ex II 2G Ex db IIC T6 Gb Ex II 2D Ex tb IIIC T85°C Db Ex I M2 Ex db IMb • IECEx Ex db IIC T6 Gb Ex tb IIIC T85°C Db Ex db IMb • CCC Ex d IIC T6 Gb Ex tD A21 IP66/IP67 T85°C
Temperature class	T4	T3	-	T6
Surface temperature	≤ 135 °C	≤ 200 °C	≤ 150 °C	≤ 85 °C
Ambient temperature (2)	-40 ÷ +40 °C	-40 ÷ +70 °C	-20 ÷ +60 °C	-40 ÷ +70 °C (3)
Applicable standards	EN 60079-0 EN 60079-1 EN 60079-31			IEC 60079-0 IEC 60079-1 IEC 60079-31
Cable entrance: threaded connection	M = M20x1,5			

(1) The type examiner certificates can be downloaded from www.atos.com

(2) The solenoids **Group II** are certified for minimum ambient temperature -40°C

In case the complete valve must withstand with minimum ambient temperature of -40°C, select **/BT** in the model code

(3) For Group I (mining) the temperature range is -20°C ÷ +70°C

⚠ WARNING: service work performed on the valve by the end users or not qualified personnel invalidates the certification

8 EX PROOF SOLENOIDS AND LVDT TRANSDUCER WIRING

Pilot valve solenoid and LVDT transducer

n°8 M4x20
locking torque 4Nm

- ① solenoid cover with threaded connection for cable gland fitting
- ② transducer cover with threaded connection for cable gland fitting
- ③ solenoid terminal board for cables wiring
- ④ transducer terminal board for cables wiring
- ⑤ screw terminal for additional equipotential grounding

Solenoid wiring

	1 = Coil	PCB 3 poles terminal board suitable for wires cross sections up to 2,5 mm² (max AWG14)
	2 = GND	
	3 = Coil	

Position transducer wiring

	1 = Output signal	PCB 4 poles terminal board suitable for wires cross sections up to 2,5 mm² (max AWG14)
	2 = Supply -15 V	
	3 = Supply +15 V	
	4 = GND	

LVDT main stage transducer

n°5 M4x20
locking torque 4Nm

- ① transducer cover with threaded connection for cable gland fitting
- ② transducer terminal board for cables wiring
- ③ ex-proof protection for LVDT transducer
- ④ LVDT transducer
- ⑤ screw terminal for additional equipotential grounding

Transducer wiring - view from X

1	= Do not connect
2	= Supply +15 V
3	= GND
4	= Output signal
5	= Supply -15 V

9 CABLE SPECIFICATION AND TEMPERATURE - Power supply and grounding cables have to comply with following characteristics:

Multicertification Group I and Group II	
Power supply: section of coil connection wires = 2,5 mm ²	Grounding: section of internal ground wire = 2,5 mm ² section of external ground wire = 4 mm ²

9.1 Cable temperature

The cable must be suitable for the working temperature as specified in the “safety instructions” delivered with the first supply of the products.

Multicertification

Max ambient temperature [°C]	Temperature class		Max surface temperature [°C]		Min. cable temperature [°C]	
	Group I	Group II	Group I	Group II	Group I	Group II
40 °C	-	T4	150 °C	135 °C	-	90 °C
60 °C	-	-	150 °C	-	110 °C	-
70 °C	N.A.	T3	N.A.	200 °C	N.A.	120 °C

10 CABLE GLANDS

Cable glands with threaded connections M20x1,5 for standard or armoured cables have to be ordered separately, see tech. table **KX800**

Note: a Loctite sealant type 545, should be used on the cable gland entry threads

11 DIAGRAMS (based on mineral oil ISO VG 46 at 50 °C)

11.1 Regulation diagrams, see note

1 = LIQZA (all sizes)

Hydraulic configuration vs. reference signal:

	standard	option /A
Reference signal 0 ÷ +10 V	} P → A	A → T
12 ÷ 20 mA		
Reference signal 0 ÷ -10 V	} A → T	P → A
4 ÷ 12 mA		

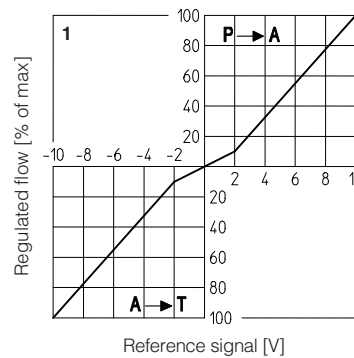

12 AIR BLEEDING

Size 25

Sizes 32, 40, 50

Sizes 63 and 80

① **Plugged port - do not open**

② **Air bleeding (MA, MB):**
N° 2 plugs G1/4"
At the machine commissioning it is advisable to bleed the air from piloting chambers, by loosening the 2 plugs MA and MB shown in the picture.
Operate the valve for few seconds at low pressure and then lock the plugs.

③ **External pilot pressure (X1):**
N° 1 plug G1/4" for sizes 32 to 100

13 FASTENING BOLTS AND VALVE MASS

Type	Size	Fastening bolts (1) supplied with the valve	Mass [kg]
LIQZA	25	4 socket head screws M12x100 class 12.9 Tightening torque = 125 Nm	15,8
	32	4 socket head screws M16x60 class 12.9 Tightening torque = 300 Nm	18,2
	40	4 socket head screws M20x70 class 12.9 Tightening torque = 600 Nm	23,7
	50	4 socket head screws M20x80 class 12.9 Tightening torque = 600 Nm	31,6
	63	4 socket head screws M30x120 class 12.9 Tightening torque = 2100 Nm	51,6
	80	8 socket head screws M24x80 class 12.9 Tightening torque = 1000 Nm	79,2

14 INSTALLATION DIMENSIONS [mm]

LIQZA-L-253

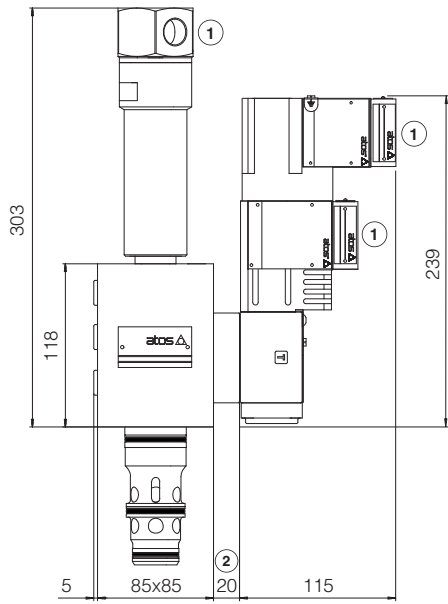

LIQZA-L-323

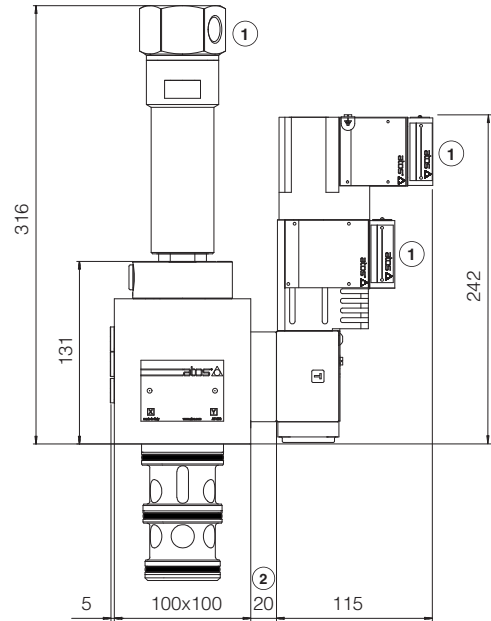

LIQZA-L-403

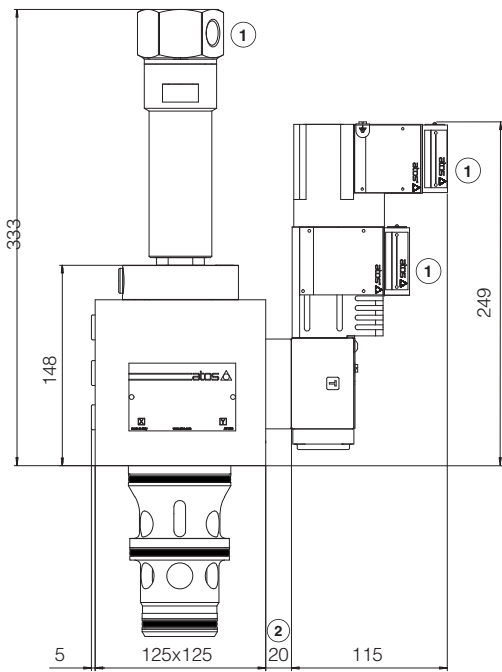

LIQZA-L-503

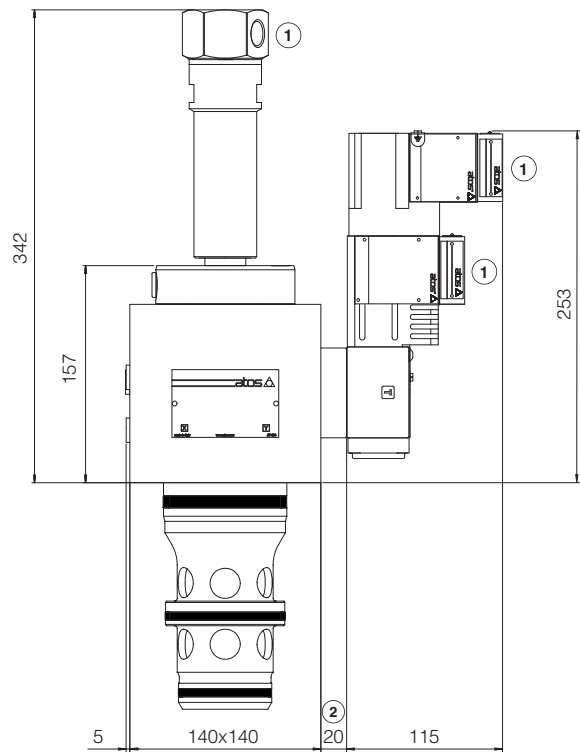

① = The dimensions of all cable glands must be considered (see tech. table **KX800**)

② = Not present for /A version

Note: for mounting surface and cavity dimensions, see table P006

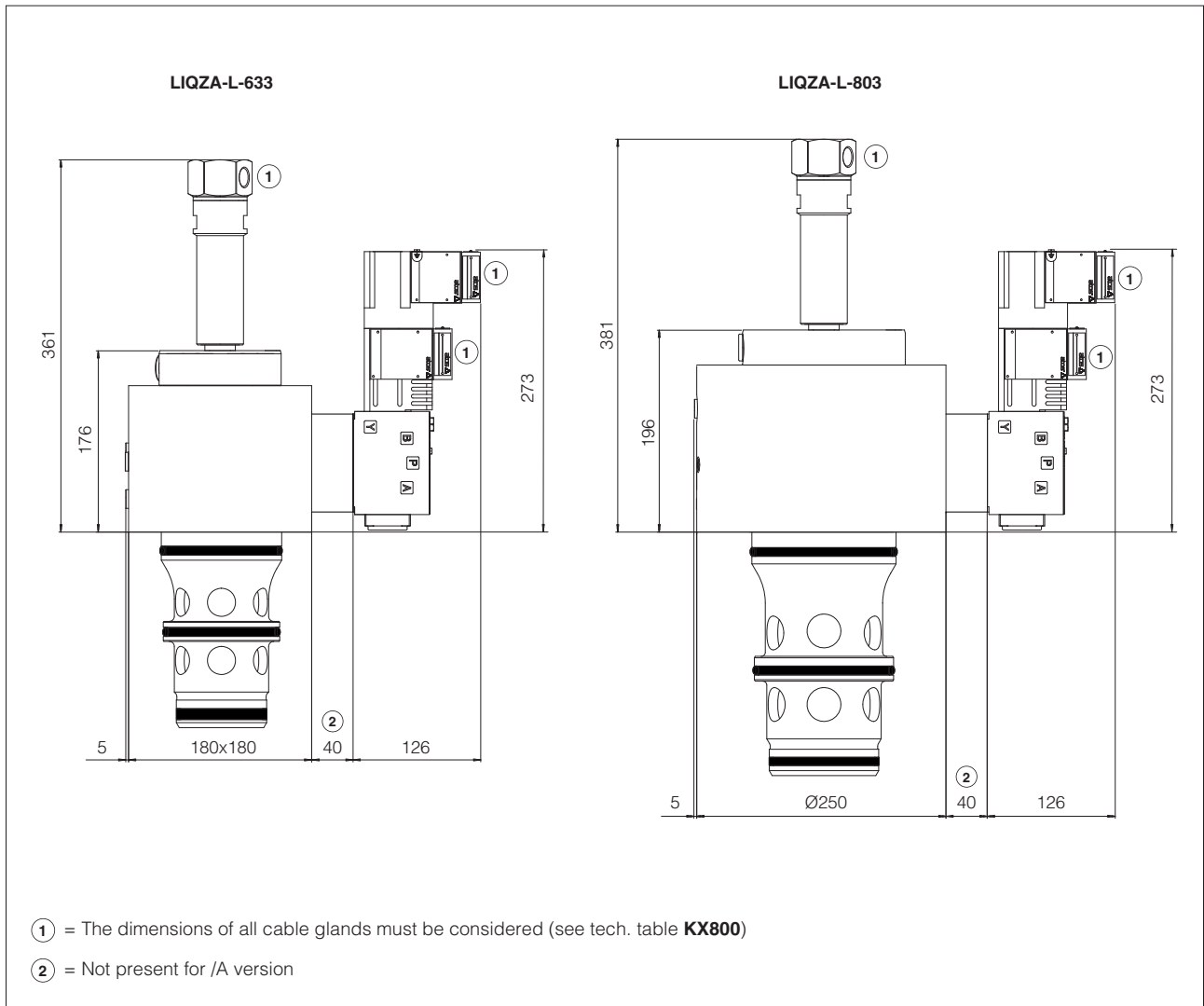

Note: for mounting surface and cavity dimensions, see table P006

15 RELATED DOCUMENTATION

X010	Basics for electrohydraulics in hazardous environments	KX800	Cable glands for ex-proof valves
X020	Summary of Atos ex-proof components certified to ATEX, IECEx, EAC, PESO, CCC	P006	Mounting surfaces and cavities for cartridge valves
FX900	Operating and maintenance information for ex-proof proportional valves		